

2019/2020 CATALOG

ISSUE 39



See pages 124 - 131 for our New Parts!



HEADER ADAPTERS



MIXER KNIVES



FORAGE HARVESTER PARTS



COMBINE PARTS



COMPOST TURNERS

Order



Online!

**Check out our Newly Redesigned Website!
New Look. Same Great Products.**

QUALITY PARTS • COMPETITIVE PRICING • EXCELLENT CUSTOMER SERVICE

**KOOIMA[®]
COMPANY**



**1.800.522.8874
www.kooima.com**

MADE IN THE USA!

Prices subject to change.

For current prices, visit our website.

All pricing in US Dollars.

¡Podemos tomar órdenes en español!

High Quality Silage Covers

String Tarps White/Black - 8.0 mil (R8WBK)

Part #	Price	W X L	Weight
K8M84X200	\$1,300.00	84 X 200	600 lbs.
K8M84X250	\$1,600.00	84 X 250	750 lbs.



String Tarps White/Black - 6.0 mil (R6WBK)

Part #	Price	W X L	Weight
K59X200M6	\$892.50	59.5 X 200	370 lbs.
K59X500M6	\$2,231.25	59.5 X 500	780 lbs.
K85X250M6	\$1,607.85	85.75 X 250	585 lbs.
K85X1000M6	\$6,431.25	85.75 X 1000	2,275 lbs.
K105X40M6	\$316.50	105.5 X 40	172 lbs.
K105X60M6	\$474.75	105.5 X 60	237 lbs.
K151X45M6	\$511.35	151.5 X 45	220 lbs.
K151X50M6	\$568.15	151.5 X 50	250 lbs.
K151X60M6	\$681.75	151.5 X 60	272 lbs.
K151X70M6	\$795.40	151.5 X 70	315 lbs.
K151X75M6	\$852.20	151.5 X 75	335 lbs.
K151X80M6	\$909.00	151.5 X 80	370 lbs.
K151X100M6	\$1,136.25	151.5 X 100	430 lbs.
K184X70M6	\$968.65	184.5 X 70	405 lbs.
K184X110M6	\$1,522.15	184.5 X 110	550 lbs.
K204X50M6	\$765.95	204.25 X 50	315 lbs.
K204X60M6	\$919.15	204.25 X 60	380 lbs.
K204X70M6	\$1,072.35	204.25 X 70	420 lbs.
K204X80M6	\$1,225.50	204.25 X 80	465 lbs.
K204X100M6	\$1,531.90	204.25 X 100	550 lbs.
K243X60M6	\$1,096.90	243.75 X 60	455 lbs.
K250X70M6	\$1,313.85	250.25 X 70	545 lbs.
K250X80M6	\$1,501.50	250.25 X 80	590 lbs.
K250X85M6	\$1,595.35	250.25 X 85	615 lbs.
K303X100M6	\$2,272.50	303 X 100	870 lbs.



Detail of reinforced string tarps

Standard Silage Tarps White/Black - 5.0 mil (A5WB1)

Part #	Price	W X L	Weight
K57442	\$108.00	24 X 100	69 lbs.
K57443	\$144.00	32 X 100	90 lbs.
K57628	\$216.00	32 X 150	133 lbs.
K46534	\$180.00	40 X 100	110 lbs.
K57574	\$270.00	40 X 150	163 lbs.
K57575	\$360.00	40 X 200	216 lbs.
K50158	\$225.00	50 X 100	138 lbs.
K50159	\$337.50	50 X 150	203 lbs.
K54235	\$450.00	50 X 200	299 lbs.
K57576	\$270.00	60 X 100	161 lbs.
K53942	\$405.00	60 X 150	255 lbs.
K57577	\$540.00	60 X 200	346 lbs.
K64369	\$2,100.60	60 X 1000	1,557 lbs.
K69881	\$540.00	80 X 150	325 lbs.
K69880	\$720.00	80 X 200	455 lbs.
K70463	\$900.00	80 X 250	561 lbs.
K77059	\$2,800.80	80 X 1000	1,999 lbs.

1-800-522-8874

If you do not see the size you need, give us a call, other sizes are available upon request.

Prices are subject to change.

*** Free shipping on Silage Covers if combined with \$750 in Kooima® parts on phone and internet orders**



PARTS INDEX

● Bale Processor Flails	2	●
● Header Drive Adapters	3-16	●
● New Parts & Round Baler Parts	17	●
● Drive Line Components	18-19	●
● Mixer Knives	20-31	●
● Manure Hammers & Composter Paddles	32	●
● Flail & Cup Knives	33	●
● John Deere [®] 5200, 5400, 5440, 5460, 5720, 5730, 5820, 5830 (replacement parts to fit)	34-47	●
● John Deere [®] 6610, 6710, 6810, 6910, 6650, 6750, 6850, 6950 (replacement parts to fit)	48-63	●
● John Deere [®] 7000 Series (replacement parts to fit)	68-87	●
● John Deere [®] 8000 Series (replacement parts to fit)	88-92	●
● John Deere [®] 3940, 3950, 3960, 3970, 35, 38 and 3800 (replacement parts to fit)	93-100	●
● John Deere [®] Corn Heads, Forage Heads and Stalker Heads (replacement parts to fit)	101-105	●
● Kemper [™] Champion [™] Heads 3000 (replacement parts to fit)	106-107	●
● Kemper [™] Blades (replacement parts to fit)	108-109	●
● Kemper [™] 4500 and John Deere [®] 676 Heads (replacement parts to fit)	110-114	●
● Kemper [™] and JD [®] 678 Large Drum Rotary Heads (replacement parts to fit)	115	●
● Kemper [™] and JD [®] 770 Large Drum Rotary Heads (replacement parts to fit)	116-117	●
● Kemper [™] and JD [®] Small Drum Rotary Heads (replacement parts to fit)	118-121	●
● Featured and NEW Parts	122-131	●
● Claas [®] Forage Harvesters & Heads (replacement parts to fit)	132-167	●
● Krone [®] Forage Harvesters & Heads (replacement parts to fit)	168-178	●
● New Holland [®] Forage Harvesters & Heads (replacement parts to fit)	180-195	●
● Case IH [®] Forage Harvesters (replacement parts to fit)	196-197	●
● Fox [®] Forage Harvesters (replacement parts to fit)	197-198	●
● Gehl [®] Forage Harvesters (replacement parts to fit)	199-201	●
● Hesston [®] Field Queen [™] Forage Harvesters (replacement parts to fit)	201	●
● Ford [®] Forage Harvesters (replacement parts to fit)	202	●
● New Idea [®] (replacement parts to fit)	202	●
● John Deere [®] No Till Drill Parts (replacement parts to fit)	203-206	●
● Battery Boxes	207	●
● Combine Index & Parts	209-220	●
Order Form	221	
Terms and Conditions of Sale	222	
Shipping Time	223	
Trner [®] Composters	224	

For over 30 years Kooima[®] Company has been manufacturing replacement forage harvester parts, combine parts, mixer knives, header adapters and more! We are an independent manufacturer of replacement parts, because of this we are able to produce quality parts at competitive prices.

**Kooima[®] Company • 2638 310th Street, Hwy. 18 East • P.O. Box 156 • Rock Valley, Iowa 51247
1-800-522-8874 • 712-476-5600 • Fax 712-476-6283 • www.kooima.com**

New Idea[®], Hesston[®], Gleaner[®], Farmhand[®], AC[®], Massey Ferguson[®] and Oliver[®] are registered trademarks of AGCO Corporation • White[™] and Field Queen[™] are trademarks of AGCO Corporation • Allis-Chalmers[™] is a trademark of Allis-Chalmers Corporation • Art's-Way[™] and Roda[™] are trademarks of Art's-Way Mfg. Co., Inc. • Badger[™] is a trademark of Badger Farm Systems, Inc. • Balzer[™] is a trademark of Balzer Inc. • Buffalo[™] is a trademark of Bison Industries, Inc. • Brillion[™] is a trademark of Brillion Farm Equipment, Landoli Corporation • Case[®], Case IH[®] and New Holland[®] are registered trademarks of CNH Industrial America, LLC • NH[™] is a trademark of CNH America, LLC • Claas[®], Lexion[®] and Speedstar[®] are registered trademarks of Claas KGaA, MBH • Mad Jag[™] is a trademark of Claas KGaA, MBH • Orbis[®] is a registered trademark of Claas Sauglau GmbH • Cressoni[™] is a trademark of F.lli CRESSONI s.p.a. • John Deere[®] and JD[®] are registered trademarks of Deere & Company • Kemper[™] and Champion[™] are trademarks of Maschinenfabrik KEMPER GmbH & Co. • Diamond[™] is a trademark of Diamond Implements • Harvestec[™] is a trademark of Linamar Agriculture Inc. • Haybuster[®] is a registered trademark of DuraTech Industries International, Inc. • Highline[®] is a registered trademark of Highline Manufacturing LTD • Ford[®] is a registered trademark of Ford Motor Company • Gehl[®] is a registered trademark of Manitou Americas, Inc. • Walterscheid[®] is a registered trademark of GKN Walterscheid GmbH • Fox[®] and Hinker[®] are registered trademarks of Hinker Company • JAY-LOR[®] is a registered trademark of JAY-LOR International Inc. • Mighty Giant[™] is a trademark of Jones Manufacturing Co. • Rock Stop[®] is a registered trademark of Kasha Farm Supplies, Ltd. • Kinze[®] is a registered trademark of KINZE Manufacturing Inc. • Kirby[™] is a trademark of Kirby Manufacturing, Inc. • Krone[®] and Big X[®] are registered trademarks of Bernard Krone Holding, GmbH & Co. KG • Kuhn[®] and Kuhn Knight[®] are registered trademarks of Kuhn S.A. • Euromix[™] is a trademark of Kuhn S.A. • Laird[™] is a trademark of Laird Manufacturing Corporation • Loftness[®] is a registered trademark of Loftness Specialized Farm Equipment, Inc. • Meyer[™] is a trademark of Meyer Manufacturing Corporation • Tatoma[®] is a registered trademark of Grupo Tatoma, S.L. • Trioliet[™] is a registered trademark of Trioliet-Mullos B.V. • Dura Drum[™] is a trademark of Deere & Company • AGM[™] is a trademark of UNIFAST s.r.l. • Loewen[™] is a trademark of Loewen Welding & Manufacturing Ltd. • Patz[™] is a registered trademark of Patz Corporation • Peecon[®] is a registered trademark of Peeters Landbouwmachines B.V. • Penta[™] is a trademark of Penta TMR, Inc • Keenan[®] is a registered trademark of Richard Keenan & Co., Ltd. • Scherer[™] is a trademark of Scherer Corrugating & Machine, Inc. • Schuitemaker[™] is a trademark of Schuitemaker Machines B.V. • Schulz[™] is a trademark of Schulz Mfg. & Equip. Co. Inc. • Seko[™] is a trademark of Seko SpA • MONOMIXER[™]/MAXIMIXER[™] is a trademark of Sioux Automation Center, Inc. • Supreme[™] is a trademark of Supreme International Ltd. • Mighty Max[™] is a trademark of Vrisimo Equipment Company, Valley Tool & Mfg • Valmetal[®] is a trademark of Valmetal Inc. • McKee[™] is a trademark of W. McKee Manufacturing Ltd. • Vermeer[®] is a registered trademark of Vermeer Manufacturing Corporation • CAT[®] is a registered trademark of CATERPILLAR INC. • Sukup[®] is a registered trademark of Sukup Manufacturing Co. • Geringhoff[®] is a registered trademark of Carl Geringhoff GmbH & Co. KG • Fantini[™] is a trademark of Fantini S.r.l. • Drago[™] and DragoTec[™] are trademarks of Dragotec USA • Gates[®] is a registered trademark of Gates Corporation • Sittler[™] is a registered trademark of Global Repair LTD • Aeromaster[®] is a registered trademark of Midwest Bio-Systems Inc. • Capello[®] is a registered trademark of CAPELLLO S.R.L. • Lazert[™] is a trademark of Kooima Company, Inc. • Koyma Klads[®], Trner[®], Kooima[®] Company and the Kooima[®] starburst logo are registered trademarks of Kooima Company, Inc. • One or more of the Kooima[®] mixer knives, Kooima[®] cracking plates, Kooima[®] shearbars, Kooima[®] spouts, Kooima[®] header adapters and Kooima[®] head cart may be protected by one or more of the following US patents 6,092,750, 6,234,072, 6,327,970, 7,290,341, 8,186,611, 8,376,126, 8,198,350, 8,109,176, 8,919,800, 9,833,785 or pending patent applications, Australian patent 2005331255 and Canadian patent 2,251,158.

Kooima® Replacement Bale Processor Flails

VERMEER® / HIGHLINE®

VERMEER® is a registered trademark of Vermeer Manufacturing Corporation, which does not manufacture, distribute or endorse these parts.
HIGHLINE® is a registered trademark of Highline Manufacturing LTD, which does not manufacture, distribute or endorse these parts.

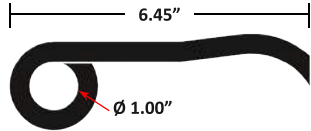

K510517232

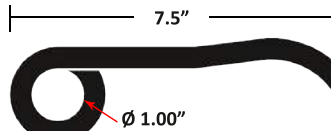

K195765

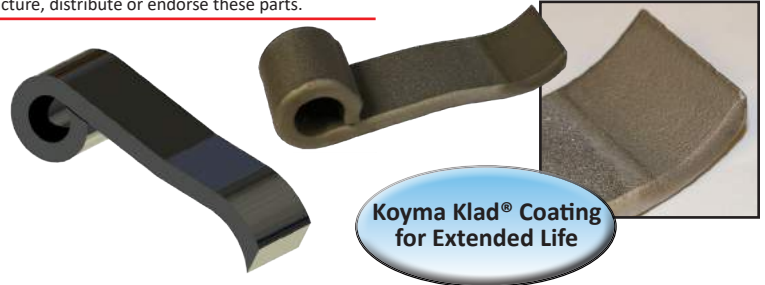

Koyma Klad® Coating
for Extended Life

Part #	DESCRIPTION	REPLACES OEM #
K195765	<ul style="list-style-type: none"> Bale Flail • 2.4 lbs. To fit Vermeer® 7000 series machines & Highline® machines Model 7000 has 26 flails 	Heat Treated
\$16.75 ea.		
K510517232	<ul style="list-style-type: none"> Bale Flail • 2.2 lbs. To fit Vermeer® models 8000 and 9000 machines Model 8000 has 26 flails • Model 9000 has 30 flails To fit Highline® 650, 651, 1251 & CFR650 	Heat Treated
\$10.25 ea.		
K510517232HP	<ul style="list-style-type: none"> Bale Flail with Koyma Klad® coating • 2.25 lbs. To fit Vermeer® models 8000 and 9000 machines Model 8000 has 26 flails • Model 9000 has 30 flails To fit Highline® 650, 651, 1251 & CFR650 	Heat Treated Tungsten Carbide
\$15.75 ea.		
K510517253	<ul style="list-style-type: none"> Bushing • .23 lbs. To fit Vermeer® 7000, 8000 & 9000 machines & Highline® machines 	
\$3.50 ea.		
K45099	<ul style="list-style-type: none"> Hex Head, knurled shoulder bolt 5/8" x 3-3/4" NF • .40 lbs. To fit Vermeer® 7000 machines & Highline® machines 	
\$8.85 ea.		
K33696H	<ul style="list-style-type: none"> Carriage bolt 5/8" x 3.75" NF • .35 lbs. To fit Vermeer® 8000 machines & Highline® machines 	
\$6.25 ea.		
K27169034	<ul style="list-style-type: none"> Bolt 5/8" x 3-1/2" gr8 NC • .35 lbs. To fit Vermeer® 9000 machines 	
\$1.65 ea.		
K396001	<ul style="list-style-type: none"> Lock nut 5/8" NF • .05 lbs. To fit Vermeer® 7000 & 8000 machines & Highline® machines 	
\$1.00 ea.		
K250513001	<ul style="list-style-type: none"> Lock nut 5/8" NC • .05 lbs. To fit Vermeer® 7000 & 9000 machines 	
\$0.90 ea.		



HAYBUSTER® / FAIR MFG.™

HAYBUSTER® is a registered trademark of DuraTech Industries International, Inc., which does not manufacture, distribute or endorse these parts.

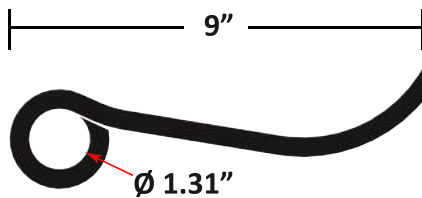

Part #
K5200012

DESCRIPTION

- Bale Flail • 2.8 lbs.
- To fit Haybuster® & Fair MFG™ (1/2" thick)
- Models 2100 & 2650 have 30 flails • Models 2564, 2655 & 2800 have 40 flails

\$11.75 ea.

K5200012HP

- Bale Flail with Koyma Klad® coating** • 3 lbs.
- To fit Haybuster® & Fair MFG™ (1/2" thick)

\$17.50 ea.

K7500223

- Models 2100 & 2650 have 30 flails • Models 2564, 2655 & 2800 have 40 flails

\$5.75 ea.

K4800598

- Bushing

\$1.90 ea.

K7900179

- .5 lbs.

\$1.65 ea.

- Bolt

- .4 lbs.

- Nut

- .1 lbs.

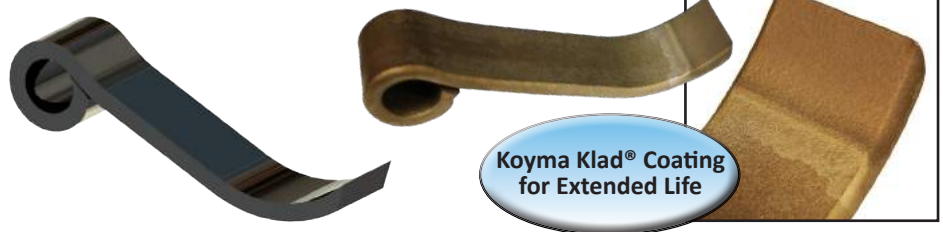

Koyma Klad® Coating
for Extended Life

REPLACES OEM #
Heat Treated

Heat Treated
Tungsten Carbide

Header Adapters

Grind Earlage with Kooima® Company header adapters!

John Deere® 8000 & 9000 Series Header Adapter

This universal grinding earlage adapter will fit all 8100-8800 and 9000 series harvesters. Patterned off our proven adapter design, this unit will work with narrow and wide throat harvesters. The standard dual drive gives you the freedom to use a variety of corn heads and eliminates having to upgrade your adapter with your harvester.

Order # K8000

\$10,600⁰⁰ ea.

Patent # 8,376,126

Customer Testimonial

"We love our Kooima earlage adapter we purchased this year to fit our 8600's chopper's 8 row shredding head. The outcome was far better than the adapter we demoed last year, and more importantly the customers were more satisfied!"

United Ag Enterprises, LLC - Wisconsin

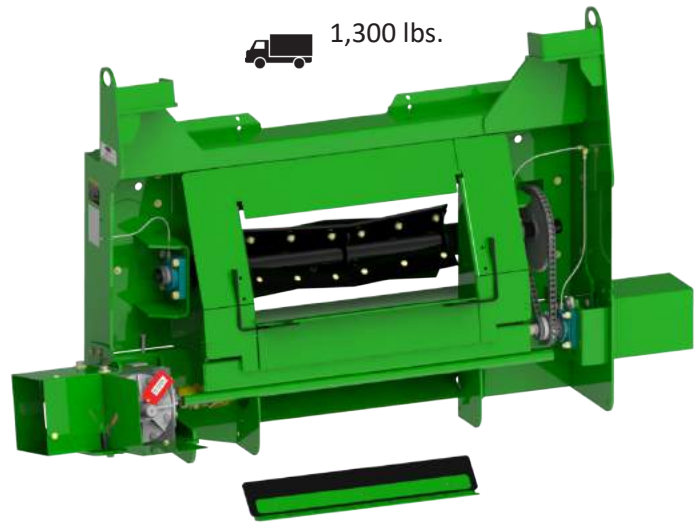

Order # K00492PTO

\$490⁰⁰ ea.

- 1 3/4" 20 spline to 1 1/8" hex • 42 lbs.
- For use with John Deere® corn head
- Compressed length 33 1/4"
- Maximum extended length 40 1/4"

Order # K20TO1250

\$490⁰⁰ ea.

- 1 3/4" 20 spline to 1 1/4" hex • 35.4 lbs.
- For use with newer John Deere® C series corn heads
- Compressed length 33 1/4"
- Maximum extended length 40 1/4"

Order # K20TO150

\$490⁰⁰ ea.

- 1 3/4" 20 spline to 1 1/2" hex
- 2400 series • 35.3 lbs.
- Compressed length 33 1/4"
- Maximum extended length 40 1/4"



Order # K8000DL

\$490⁰⁰ ea.

- Chopper to gearbox driveline
- Used if chopper is equipped with quick connect system • 47 lbs.



Don't waste costly downtime - replace your gearbox oil every season. 4 quarts needed. With gearbox sitting level, take the plug out of the back of the gearbox and pour oil through the top hole to fill until the oil is up to the level of the back hole.

- 2 lbs. • 1 quart

Order # 75W-90PS

\$13⁰⁰ ea.



WARNING - Grinding earlage with the use of corn heads and choppers can cause a risk of fire. The risk of fire does not emanate from the adapter products described on this page, but can be caused by heat generated by the choppers. To reduce the risk of fire, please keep the top of feed roll housing clear of dust.

John Deere® and JD® are registered trademarks of Deere & Company. Truck icon signifies product is shipped via truck freight.

To order toll free: 1-800-522-8874 • By fax: 712-476-6283 • Online: www.kooima.com • E-mail: sales@kooima.com

- 1 3/4" 20 spline to 1 3/8" 21 spline adapter
- Use with longer factory back shafts

Order # K1172821

5.8 lbs.

\$180⁷⁵ ea.



- K8000 RH drive chain
- #60 Heavy roller chain
- 66 pitches • 4.5 lbs.

Order # 60H-66

\$55³⁵ ea.



KOOIMA®
COMPANY



Header Adapters

Grind Earlage with Kooima® Company header adapters!

John Deere® 6000 & 7000 Series Header Adapter

The adapter work horse, this adapter will allow you to gain the ground speed to get your job done faster. With the improved crop flow design and enclosed heavy duty gear box this is the most efficient header adapter on the market today. This adapter will work with John Deere® 600 series (excluding 606C) 40 and 90 series corn heads and has the ability to switch between narrow and wide throat harvesters easily.

Order # K00075

\$12,500⁰⁰ ea.

Patent # 8,376,126

Order # KIH7000

\$375⁸⁰ ea.

JD® cutter to Case IH® narrow throat heads (2200 series)

Call for Details

Easy PTO Hook-Ups



Wide Throat



Front View

Easy Flow Floor For Better Crop Feeding

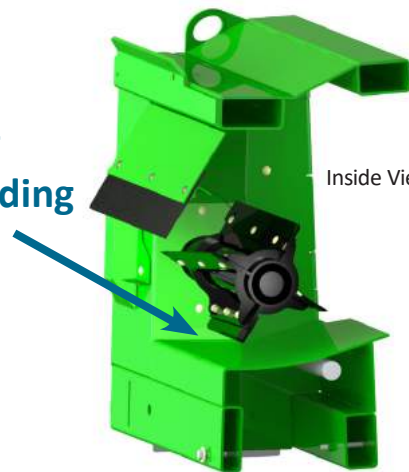

Inside View

1,310 lbs. 

- Reversible
- Assist Feed
- 1 : 1.3 Gearbox

See us on
YouTube



7 quarts of oil needed for the gearbox. Fill up to the fill hole.

• 2 lbs. • 1 quart

Order # 75W-90PS

\$13⁰⁰ ea.

WARNING - Grinding earlage with the use of corn heads and choppers can cause a risk of fire. The risk of fire does not emanate from the adapter products described on this page, but can be caused by heat generated by the choppers. To reduce the risk of fire, please keep the top of feed roll housing clear of dust.

John Deere® and JD® are registered trademarks of Deere & Company. Truck icon signifies product is shipped via truck freight.

To order toll free: 1-800-522-8874 • By fax: 712-476-6283 • Online: www.kooima.com • E-mail: sales@kooima.com

Header Adapters

Components for John Deere® adapter K00075

When ordering your adapter, don't forget to order the left side PTO shaft and earlage pans.

Earlage kit for the side walls of feed rolls. This kit will open up the feed rolls and prevent corn from exiting the sides. A real **MUST** when grinding earlage!

Order # K7000KIT

- 7050 series machines only
- To use on 7200-7500 series order # K101960BK also

\$450⁰⁰ ea.

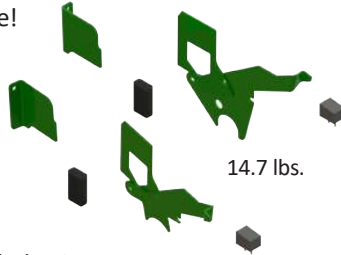

14.7 lbs.

Longer rear spring eye bolt • Includes 2 nuts

- Needed when separating feed rolls for earlage
- Use with K7000KIT & K6000KIT

\$37⁰⁵ ea. Order # K162269



1.4 lbs.

Belt for 2011 Models and Later

Order # 14-MGT-1568-125

\$875⁸⁰ ea.



5 lbs.

Assist feed flaps

- Mounted to the flap wheel to help feed the cutter even more!
- 4 required • Rubber extension flaps

Order # K75FLAP

\$25³⁰ ea.



2.5 lbs.

Order # KFLAPBK - Bolt Kit - \$2.65 ea.

Adapt your **New Holland®** and **Case IH® 3000 series** to your John Deere® chopper. Wide head & wide throat. 90 lbs.

Order # K98CJD

\$850⁸⁰ ea.



Order # K4000CH - Adapts your **4000 series Case IH®** head to your chopper

Back two feed rolls can throw corn forward when grinding ear corn • Keeps the corn in the chopper • Help prevent expensive corn loss- install your shell kit today!

- Use on Claas® and JD® adapters

Order # KSHELLKIT1

\$150⁷⁵ ea.

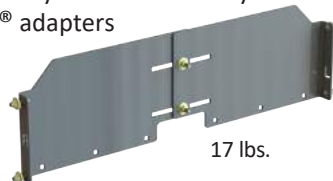

17 lbs.

- Optional rubber flap
- Use on John Deere® adapters only • 4 lbs.

Order # KSHELLKIT2

\$90⁴⁵ ea.



Order # K21TO150

\$490⁰⁰ ea.

- 21 spline to 1 1/2 hex
- Used with JD® C heads 2012 or newer
- Compressed length 33 1/4"
- Extended length 40 1/4"



34.2 lbs.

PTO Shafts

K21SP1250HEX • 1 1/4" hex to 1 3/8" 21 spline • 18.1 lbs.

K21SP1500HEX • 1 1/2" hex to 1 3/8" 21 spline • 17.6 lbs.

K21SP1125HEX • 1 1/8" hex to 1 3/8" 21 spline • 18.3 lbs.

\$490⁰⁰ ea.



Order # FH002943

- 1 1/2" 23 spline to 1 3/4" 20 spline shaft
- Replacement Drive Shaft • 4.85 lbs.

\$175⁰⁰ ea.



Order # K23TO23MALE

- 1 1/2" 23 spline to 1 1/2" 23 spline
- Drive PTO, Replacement Drive Line

\$490⁰⁰ ea.



18.6 lbs.

Earlage Pans for Wide Throat Machines 7700-7850

K79268 - \$210.75 ea.

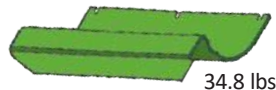

34.8 lbs.

K64453 - \$160.75 ea.

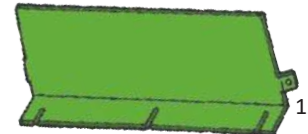

12.3 lbs.

Earlage Pans for Standard Width Machines

K63659 - \$70.45 ea.

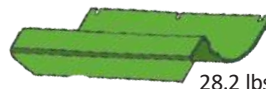

28.2 lbs.

K50086 - \$80.45 ea.

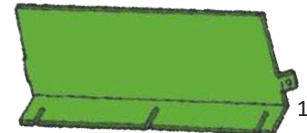

12.3 lbs.

K50086BK

- Earlage pans bolt kit • To fit all series earlage pans • .25 lbs.
- 1 kit required - \$6.25

Header Adapters

Grind Earlage with **Kooima® Company** header adapters!

John Deere® 6000 & 7200-7580 Series Header Adapter

Another option to grind earlage for all 6000 series and 7200-7580 series harvesters. This adapter has the advantage of the additional corn saver roller and simple oil bath gearbox. Use with JD® 40 and 90 series corn heads. Will also fits Harvestec™ and Cressoni™ corn heads with JD® hook ups. (JD® 600 series corn heads do not fit this adapter.)

Order # K00019

\$7,500⁰⁰ ea.

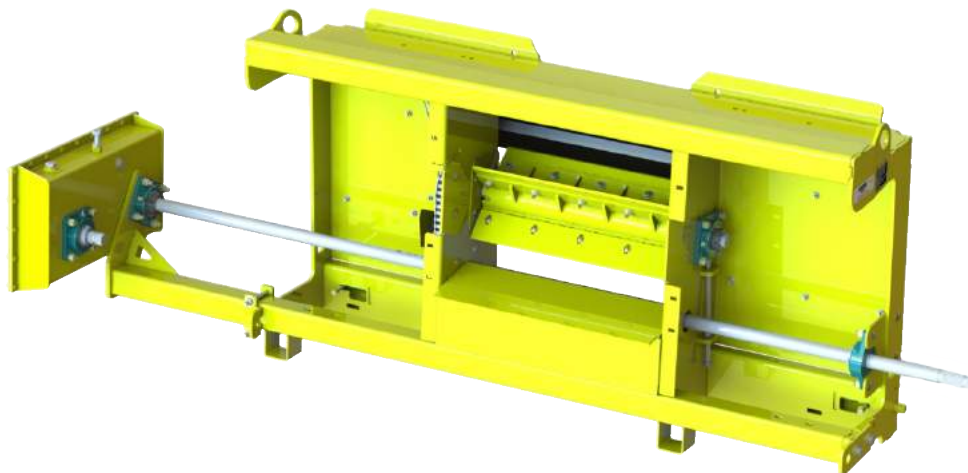

1,100 lbs. 

- Reversible
- Assist Feed
- Easy PTO Hook-Up

See us on
YouTube



Inside View

K21TO21 • 21 spline to 21 spline, 17.15 lbs.

K21TO23 • 21 spline to 23 spline, 17.4 lbs.

- Special Walterscheid® PTO for higher horsepower conditions
- Compressed length 14 1/4"
- Maximum extended length 15 1/2"

\$490⁰⁰ ea.



WARNING - Grinding earlage with the use of corn heads and choppers can cause a risk of fire. The risk of fire does not emanate from the adapter products described on this page, but can be caused by heat generated by the choppers. To reduce the risk of fire, please keep the top of feed roll housing clear of dust.

John Deere® and JD® are registered trademarks of Deere & Company. Truck icon signifies product is shipped via truck freight.

To order toll free: 1-800-522-8874 • By fax: 712-476-6283 • Online: www.kooima.com • E-mail: sales@kooima.com

Header Adapters

Components for John Deere® header adapters

These header drives are required when attaching John Deere® 40 and 90 series combine corn heads to 7200-7500 series John Deere® forage harvesters.

Order # K00055

\$4,000⁰⁰ ea.



Header Drive 16 Tooth Sprocket

Order # FH500073

- Use with 23 spline LOC gear box
- 2.3 lbs.

\$60⁴⁵ ea.



Header Drive 16 Tooth Sprocket

Order # FH500072

- Use with 21 spline LOC gear box
- 2 lbs.

\$60⁴⁵ ea.



Order # 60D-16 Double 60 connection chain - \$25.30 ea.

Assist feed flaps

- Mounted to the flap wheel to help feed the cutter even more!
- 4 required • Rubber extension flaps

Order # K19FLAP

\$25³⁰ ea.



Order # KFLAPBK - Bolt Kit - \$2.65 ea. .55 lbs.

PTO Shafts for 90 series corn heads

K24224295

- 1 1/8 hex to 21 spline, 19.1 lbs.
- To drive a Kooima® adapter to corn head
- Compressed length 16 7/8"
- Maximum extended length 18 1/2"

K24224018

- 1 1/4 hex to 21 spline, 19 lbs.
- To drive a Kooima® adapter to corn head
- Compressed length 16 7/8"
- Maximum extended length 18 1/2"

\$490⁰⁰ ea.



To drive 643 head when buying adapter K00019 and for all 7000 series machines. 10.4 lbs.

Order # K643SH

\$100⁷⁵ ea.



To drive 843 head when buying adapter K00019 and for all 7000 series machines. 25 lbs.

Order # K843SH

\$100⁷⁵ ea.

Maintenance Kits for K00019

Don't waste costly downtime - replace your gearbox oil every season. • 7.8 lbs.

Order # OILAGMA5EP

\$45³⁵ ea.



Adapter kit for 7000 series machines

Order # K00029

\$350⁸⁰ ea.

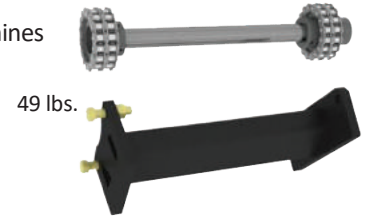

14 tooth 60 chain
Order # K2114CH

\$15³⁰ ea.



21 spline to 14 tooth sprockets
Order # K2114

\$60⁴⁵ ea.

Eargle kit for the side walls of feed rolls. This kit will open up the feed rolls and prevent corn from exiting the sides. A real **MUST** when grinding eargle!



Order # K7000KIT • 14.7 lbs.

- 7050 series machines only
- To use on 7200-7500 series order # K101960BK also

\$450⁰⁰ ea.

Order # K6000KIT

- All 6000 and 7000 series machines only
- 4.8 lbs.

\$350⁰⁰ ea.

Longer rear spring eye bolt • Includes 2 nuts

- Needed when separating feed rolls for eargle
- Use with K7000KIT & K6000KIT

Order # K162269

\$37⁰⁵ ea.



- Back two feed rolls can throw corn forward when grinding ear corn
- Keeps the corn in the chopper • Help prevent expensive corn loss - install your shell kit today! • Use on Claas® and JD® adapters

Order # KSHELLKIT1

\$150⁷⁵ ea.



- Optional rubber flap
- Use on John Deere® adapters only • 4 lbs.

Order # KSHELLKIT2

\$90⁴⁵ ea.



Header Adapters

Grind Earlage with **Kooima® Company** header adapters!

Claas® 491, 492, 493, 494, 496 & 497 Series Header Adapters

Claas® grinding earlage adapter to fit 491, 492, 493, 494, 496 and 497 series machines to attach **ALL** John Deere® corn heads. Also fits Lexion®, Harvestec™ and Cressoni™ heads. Kooima's® newly patented design, equipped with the corn saver system keeps crop moving through your machines.

Order # K00492

- To fit 491 & 492 series

\$10,500⁰⁰ea.

Order # K00494

- To fit 493, 494, 496 & 497 series

\$10,500⁰⁰ea.

Patent # 8,376,126

Order # FH5001131

- Quick connect drive coupler
- Use with K00494 adapter
- 10.2 lbs.

\$425⁰⁰ea.



Better Crop Flow Floor

**PTO Hook-Up
for 491 & 492
Machines**



Inside View

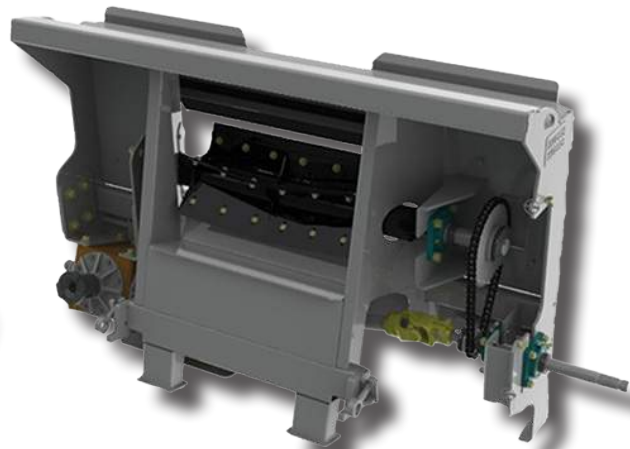

967 lbs. 

Wide Throat

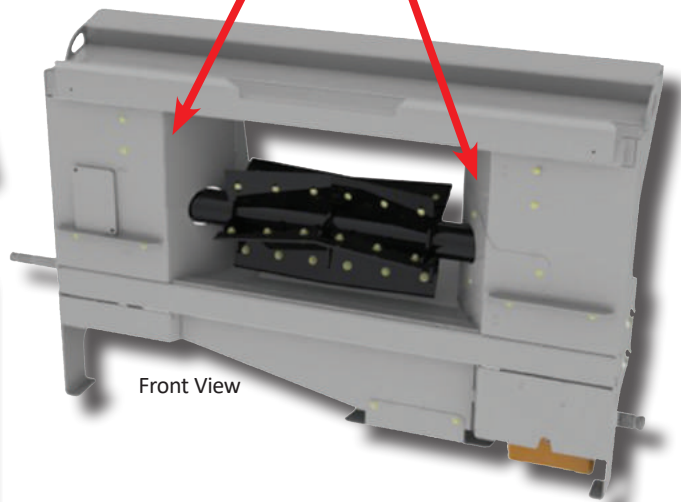

Front View

**Reversing capabilities from the cab
with NO BELTS!**



WARNING - Grinding earlage with the use of corn heads and choppers can cause a risk of fire. The risk of fire does not emanate from the adapter products described on this page, but can be caused by heat generated by the choppers. To reduce the risk of fire, please keep the top of feed roll housing clear of dust.

Claas® is a registered trademark of Claas KGaA, MBH. Truck icon signifies product is shipped via truck freight.

To order toll free: 1-800-522-8874 • By fax: 712-476-6283 • Online: www.kooima.com • E-mail: sales@kooima.com

Header Adapters

We can fit your Claas® to most any combine corn head!
Components for Claas® header adapters



Order # K00492PTO
\$490⁰⁰ ea.
 • 1 3/4" 20 spline to 1 1/8" hex • 42 lbs.
 • For use with John Deere® corn head
 • Compressed length 33 1/4"
 • Maximum extended length 40 1/4"

Order # K20TO1250
\$490⁰⁰ ea.
 • 1 3/4" 20 spline to 1 1/4" hex • 35.4 lbs.
 • For use with newer John Deere® C series corn heads
 • Compressed length 33 1/4"
 • Maximum extended length 40 1/4"

Order # K20TO150
\$490⁰⁰ ea.
 • 1 3/4" 20 spline to 1 1/2" hex
 • 2400 series • 35.3 lbs.
 • Compressed length 33 1/4"
 • Maximum extended length 40 1/4"

Order # K6TO1250
\$490⁰⁰ ea.
 • 1 3/8" 6 spline to 1 1/4" hex
 • 2400 series • 35 lbs.
 • Compressed length 33 1/4"
 • Maximum extended length 40 1/4"

Order # K21TO1250
\$490⁰⁰ ea.
 • 1 3/8" 21 spline to 1 1/4" hex
 • 2400 series • 35 lbs.
 • Compressed length 33 1/4"
 • Maximum extended length 40 1/4"
 • Used with Case® 3000 series heads on right drive side

Assist feed flaps

- Mounted to the flap wheel to help feed the cutter even more!
- 5 required • Rubber extension flaps
- Will work on all Claas® grinding adapters made by Kooima®

Order # K494FLAP
\$25³⁰ ea.



Order # KFLAPBK - Bolt Kit - \$2.65 ea. .55 lbs.

To be used with PTO Driven Heads. To convert left side of gear box to a 1 3/8" 21 spline.
 • 1 3/4" 20 spline to 1 3/8" 21 spline adapter

Order # K1172821
 5.8 lbs.

\$180⁷⁵ ea.



1 3/8" 6 spline adapters

1 3/4" 20 spline to 1 3/8" 6 spline adapter.

Order # K33201476 5 lbs.

1 3/8" 21 spline to 1 3/8" 6 spline

Order # K33200087 2.8 lbs.

\$185⁰⁰ ea.



- Drive shaft • 21 spline to 1 1/8" hex • 33" collapsed length
- Replacement shaft for 90 series side hill corn heads • 29.5 lbs.

Order # K119746

Replaces OEM # AH119746

\$490⁰⁰ ea.



20.8 lbs.

Order # K491PTO
\$490⁰⁰ ea.

- Header drive PTO
- For use with 491 & 492 series machines
- No slip clutch

Grinding ear corn pan to fit 491, 492 & 493 series Claas® harvesters.
 Replaces OEM # 9842901

Order # K9842901
\$140⁷⁵ ea.



16.3 lbs.

Adapt your **New Holland® and Case IH® 3000 series** to your Claas® chopper. When using this attachment, a PTO is needed with 1 3/8" 21 spline to 1 1/4" hex ends for the right side of equipment.
 90 lbs.

Order # K98CJD
\$850⁸⁰ ea.



Order # K4000CH - Adapts your **4000 series Case IH®** head to your chopper

Maintenance Kits for K00492 & K00494



Don't waste costly downtime - replace your gearbox oil every season. 4 quarts needed. With gearbox sitting level, take the plug out of the back of the gearbox and pour oil through the top hole to fill until the oil is up to the level of the back hole. • 2 lbs. • 1 quart

Order # 75W-90PS **\$13⁰⁰** ea.

- Back two feed rolls can throw corn forward when grinding ear corn
- Keeps the corn in the chopper • Help prevent expensive corn loss - install your shell kit today!
- Use on Claas® and JD® adapters

Order # KSHELLKIT1
\$150⁷⁵ ea.



17 lbs.

If using a John Deere® 40 series corn head, you will need to change to a PTO drive system. See kit # KAR100.

Order # KAR100
\$990⁰⁰ ea.



85 lbs.

WARNING - Grinding earlage with the use of corn heads and choppers can cause a risk of fire. The risk of fire does not emanate from the adapter products described on this page, but can be caused by heat generated by the choppers. To reduce the risk of fire, please keep the top of feed roll housing clear of dust.

To order toll free: 1-800-522-8874 • By fax: 712-476-6283 • Online: www.kooima.com • E-mail: sales@kooima.com

KOOIMA
 COMPANY



Header Adapters

Grind Earlage with **Kooima® Company** header adapters!

Claas® - Case IH® Header Adapter

Claas® grinding earlage adapter to fit all series to attach 900, 1000 & 2200 (Narrow Throat) series Case IH® corn heads. Equipped with the corn saver system to keep crops moving through and help cut up the cobs before entering the front feed roll. Will not fit 1083 heads with short drive lines.

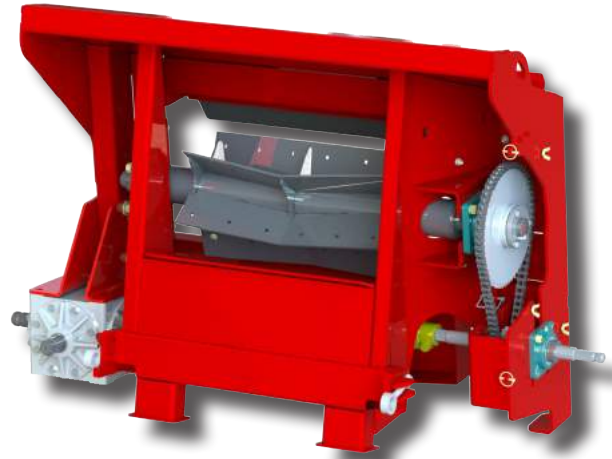

Order # K00080 

- To fit 491 & 492
- 1,000 lbs.

Order # K00084 

- To fit 493, 494, 496 & 497 series
- 1,000 lbs.

\$9,000⁰⁰ ea.

Patent # 8,376,126

Order # FH5001131

- Quick connect drive coupler
- Use with K00084 adapter • 10.2 lbs.

\$425⁰⁰ ea.



Reversing capabilities from the cab with NO BELTS!



28.7 lbs.

Order # K00080PTO

\$490⁰⁰ ea.

- 1 3/4" 20 spline to 1 1/4" hex
- For use with a Case IH® corn head
- Compressed length 23 1/2"
- Maximum extended length 35"

Assist feed flaps

- Mounted to the flap wheel to help feed the cutter even more!
- 5 required • Rubber extension flaps

Order # K84FLAP

\$25³⁰ ea.



2.5 lbs.

Order # KFLAPBK - Bolt Kit - **\$2.65 ea.** .55 lbs.

- 1 3/8" 21 spline to 1 3/8" 6 spline (540) adapter

Order # K33200087

\$185⁰⁰ ea.



2.8 lbs.

- Header drive PTO
- For use with 491 & 492 series machines
- No slip clutch

Order # K491PTO

\$490⁰⁰ ea.



20.8 lbs.



Back two feed rolls can throw corn forward when grinding ear corn
 • Keeps the corn in the chopper • Help prevent expensive corn loss- install your shell kit today! • Use on Claas® and JD® adapters

Order # KSHELLKIT1

\$150⁷⁵ ea.



17 lbs.

Maintenance Kits for K00080

Don't waste costly downtime - replace your gearbox oil every season. 4 quarts needed. With gearbox sitting level, take the plug out of the back of the gearbox and pour oil through the top hole to fill until the oil is up to the level of the back hole. • 2 lbs. • 1 quart

Order # 75W-90PS **\$13⁰⁰ ea.**



WARNING - Grinding earlage with the use of corn heads and choppers can cause a risk of fire. The risk of fire does not emanate from the adapter products described on this page, but can be caused by heat generated by the choppers. To reduce the risk of fire, please keep the top of feed roll housing clear of dust. Claas® is a registered trademark of Claas KGaA, MBH. Case® and Case IH® are registered trademarks of CNH Industrial America, LLC.

To order toll free: 1-800-522-8874 • By fax: 712-476-6283 • Online: www.kooima.com • E-mail: sales@kooima.com

Header Adapters

Claas® - Lexion® Header Adapter

Claas® grinding earlage adapter to fit 491, 492, 493, 494, 496 & 497 series machines to attach **ALL** John Deere® corn heads. Also fits Lexion®, Harvestec™ and Cressoni™ heads. Equipped with the corn saver system to keep crops moving through and help cut up the cobs before entering the front feed roll.

Order # K00492 
• To fit 491 & 492 series

\$10,500⁰⁰ ea.

Order # K00494 
• To fit 493, 494, 496 & 497 series

\$10,500⁰⁰ ea.

Patent # 8,376,126



Order # FH5001131
• Quick connect drive coupler
• Use with K00494 adapter
• 10.2 lbs.

\$425⁰⁰ ea.



Order # KLEX12LEFT

\$490⁰⁰ ea.

- 1 3/4" 20 spline to 1 3/8" 6 spline
- LH side 2500 series PTO for 12-row Lexion® heads
- Compressed length 32 1/4"
- Maximum extended length 41"



- Assist feed flaps
- Mounted to the flap wheel to help feed the cutter even more! • 5 required
- Rubber extension flaps

Order # K494FLAP

\$25³⁰ ea.



2.3 lbs.

Order # KFLAPBK - Bolt Kit - **\$2.65 ea.** .55 lbs.

Conversion Kit

This kit bolts to K00492 or K00494 to adapt a Claas® cutter to a Lexion® corn header.

Order # KLEKKIT

\$890⁰⁰ ea.



100 lbs.

Back two feed rolls can throw corn forward when grinding ear corn • Keeps the corn in the chopper • Help prevent expensive corn loss- install your shell kit today! • Use on Claas® and JD® adapters

Order # KHELLKIT1

\$150⁷⁵ ea.



17 lbs.

If you have a 493 or 494 series machine, use the original equipment PTO shaft on the machine.



Order # K491PTO

\$490⁰⁰ ea.

- Header drive PTO
- For use with 491 & 492 series machines
- No slip clutch

To convert left side of gear box to a 1 3/8" 21 spline.

- 1 3/4" 20 spline to 1 3/8" 21 spline adapter

To be used on 8-row heads.

Order # K1172821 5.8 lbs.



\$180⁷⁵ ea.

1 3/4" 20 spline to 1 3/8" 6 spline adapter. To convert large thousand spline to 6 spline hook up.

Order # K33201476 5 lbs.



\$185⁰⁰ ea.

WARNING - Grinding earlage with the use of corn heads and choppers can cause a risk of fire. The risk of fire does not emanate from the adapter products described on this page, but can be caused by heat generated by the choppers. To reduce the risk of fire, please keep the top of feed roll housing clear of dust. Truck icon signifies product is shipped via truck freight. Claas® is a registered trademark of Claas KGaA, MBH

To order toll free: 1-800-522-8874 • By fax: 712-476-6283 • Online: www.kooima.com • E-mail: sales@kooima.com

KOOIMA
COMPANY



Header Adapters

Adapters to fit:
New Holland® FX 40, 50 & 60 Series Harvesters
ALL New Holland® FR Series Harvesters

We have adapters to fit: John Deere® heads, New Holland® heads & Case IH® 3000 series heads

FX Option

Order # KFX60

To fit all the "O" series

FX machines only

\$10,500⁰⁰ ea.

FR Option

Order # KFR9000

To fit FR series machines

\$10,500⁰⁰ ea.

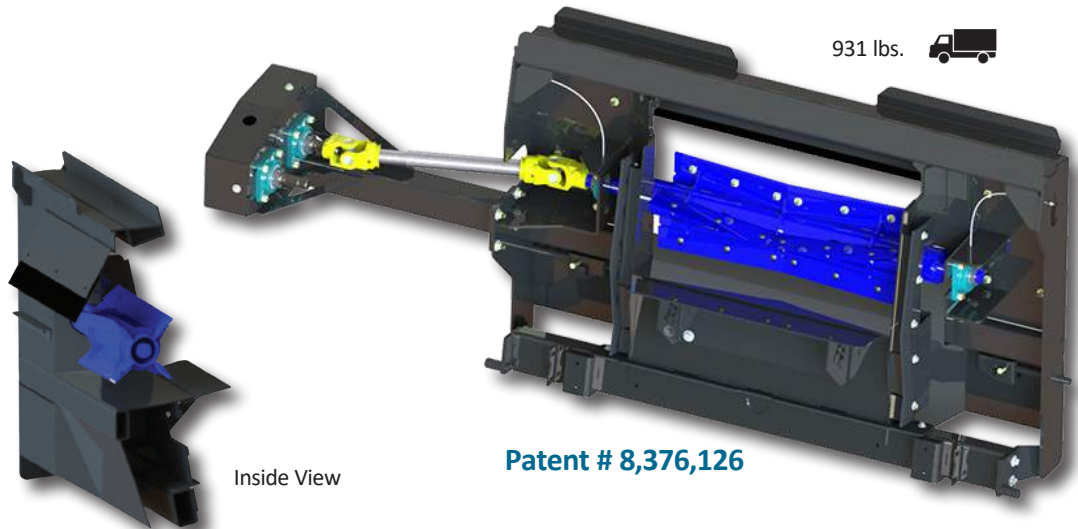

Patent # 8,376,126

Grain Saver Plates for the bottom of the feed rolls

Order # K87629289

Replaces OEM # 87629289

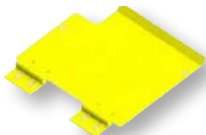

6.4 lbs.

\$90⁴⁵ ea.

Order # K87629290

Replaces OEM # 87629290

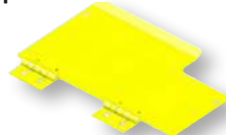

7.1 lbs.

\$90⁴⁵ ea.

Grain Saver Plates for the side of the feed rolls

Fits the FR machines only

Does not fit FR500 and FR600 series machines

Order # KFRKIT

\$275⁷⁵ ea.

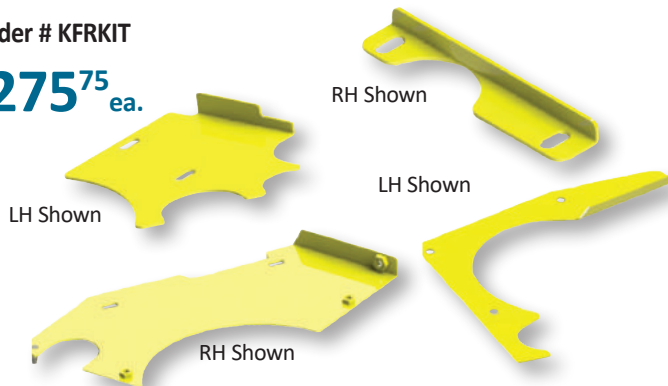

Order # K20251500

\$490⁰⁰ ea.

45.5 lbs.

- 1 3/4" spline to 1 1/2" hex
- LH side 2500 series PTO
- Compressed length 30 3/8"
- Maximum extended length 46"
- 2 required

Order # K98CPTO-R

\$490⁰⁰ ea.

38.9 lbs.

- 1 1/4" hex to 1 3/4" 20 spline
- RH side 2500 series PTO for New Holland® heads, 1 required
- Compressed length 19 1/4"
- Maximum extended length 23 1/4"

Order # K98CPTO-L

\$490⁰⁰ ea.

50.7 lbs.

- 1 1/4" hex to 1 3/4" 20 spline
- LH side 2500 series PTO for New Holland® heads, 1 required
- Compressed length 30 3/8"
- Maximum extended length 46"
- Also used for JD® heads with 1 1/4" hex shafts, 2 required

Order # KJDNH1.13HEX

\$490⁰⁰ ea.

45.2 lbs.

- 1 1/8" hex to 1 3/4" 20 spline
- LH side 2500 series PTO
- Compressed length 30 3/8"
- Maximum extended length 46"
- Used for JD® heads with 1 1/8" hex shafts, 2 required

WARNING - Grinding earlage with the use of corn heads and choppers can cause a risk of fire. The risk of fire does not emanate from the adapter products described on this page, but can be caused by heat generated by the choppers. To reduce the risk of fire, please keep the top of feed roll housing clear of dust. New Holland® is a registered trademark of CNH Industrial America, LLC. Truck icon signifies product is shipped via truck freight.

To order toll free: 1-800-522-8874 • By fax: 712-476-6283 • Online: www.kooima.com • E-mail: sales@kooima.com

Header Adapters

Corn Saver Plate

Back feed rolls of your chopper can throw corn forward when grinding ear corn, this plate keeps the corn in the chopper. Help prevent expensive corn loss - install your corn saver plate today!

Order # FH003682 **\$90⁴⁵** ea.



Assist feed flaps

- Mounted to the flap wheel to help feed the cutter even more!
- 4 required • Rubber extension flaps

Order # KFX60FLAP or # KFR9000FLAP

\$25³⁰ ea.



Order # KFLAPBK - Bolt Kit - \$2.65 ea., .55 lbs.

Adapt your **New Holland® and Case IH® 3000 series** heads to your New Holland® chopper.

90 lbs.

Order # K98CJD

\$850⁸⁰ ea.



Order # K4000CH - Adapts your **4000 series Case IH® head** to your chopper

New Holland® FX 25, 35, 38, 45, 48 & 58 Series Adapter

Based off the proven K00019 adapter design. Now available for the New Holland® SPFH.

Order # K00019

\$7,500⁰⁰ ea.

Order # KFX38

\$750⁸⁰ ea.

- Conversion Kit
- Use this kit to adapt to NH™ harvesters



KFX38 Conversion Kit

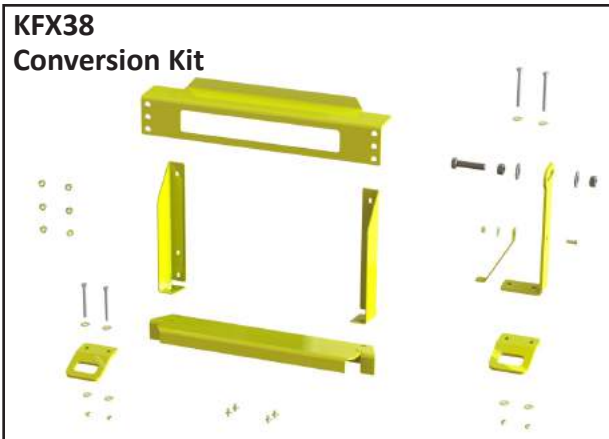

KFX38PTO • Chopper to gearbox PTO
\$490⁰⁰ ea. • 21 spline to 21 spline • 18.5 lbs.

PTO Shafts for 90 series corn heads

K24224295 • 1 1/8 hex to 21 spline, 19.1 lbs.

K24224018 • 1 1/4 hex to 21 spline, 19 lbs.

\$490⁰⁰ ea.



Header Adapters

ATTENTION: Krone® Owners

High performance model adapter - don't grind ear corn behind the pack!
Contact Kooima® for your new feed assist paddle system header adapter today!

Order # KR0040

1,196 lbs. 

Patent # 8,376,126

\$12,000⁰⁰ ea.

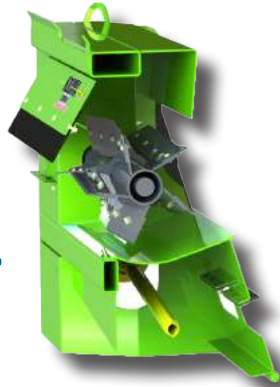

We have adapters to fit:

John Deere® heads, New Holland® heads, Case IH® 3000 series heads & Lexion®

Adapt your **New Holland® and Case IH® 3000 series** heads to your Krone® Chopper. 90 lbs.

(New Drive Lines will be needed.)

Order # K98CJD

\$850⁸⁰ ea.



Order # K4000CH - Adapts your **4000 series** Case IH® head to your chopper

Bottom earlage pan
Order # FH002479

\$75⁴⁵ ea.

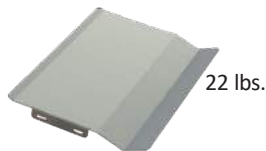

22 lbs.

Front earlage pan
Order # FH002480

\$75⁴⁵ ea.

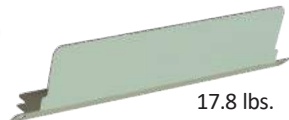

17.8 lbs.

To be used with PTO Driven Heads. To convert left side of gear box to a 1 3/8" 21 spline. • 5.8 lbs.

• 1 3/4" 20 spline to 1 3/8" 21 spline adapter

Order # K1172821

\$180⁷⁵ ea.



Krone® cutter to a Lexion® corn header conversion kit.

Order # KLEXKIT

\$890⁰⁰ ea.



100 lbs.



- 1 3/4" 20 spline to 1 1/8" hex
- Compressed length 33 1/4"
- Max extended length 40 1/4"

Order # K00492PTO

\$490⁰⁰ ea.

- 1 3/8" 6 spline to 1 1/4" hex
- 2400 series • 35 lbs.
- Compressed length 33 1/4"
- Max extended length 40 1/4"

Order # K6TO1250

\$490⁰⁰ ea.

- 1 3/4" 20 spline to 1 3/8" 6 spline
- 2500 series PTO
- Compressed length 32 1/4"
- Max extended length 41"

Order # KLEX12LEFT

\$490⁰⁰ ea.

- Krone® input PTO
- If you have a Bi-fold Krone® head you will need this PTO when you mount a Kooima® adapter
- 1 3/4" 20 spline to 1 3/4" 20 spline
- Compressed length 33 1/2"

Order # KR0040PTO

\$490⁰⁰ ea.

- 1 3/4" 20 spline to 1 1/2" hex
- Compressed length 33 1/4"
- Max extended length 40 1/4"

Order # K20TO150

\$490⁰⁰ ea.

- 1 3/8" 21 spline to 1 1/4" hex
- 2400 series • 35 lbs.
- Compressed length 33 1/4"
- Max extended length 40 1/4"
- Used with Case® 3000 series heads

Order # K21TO1250

\$490⁰⁰ ea.

- 1 3/4" 20 spline to 1 1/4" hex
- Compressed length 33 1/4"
- Max extended length 40 1/4"

Order # K20TO1250

\$490⁰⁰ ea.

Assist feed flaps

- Mounted to the flap wheel to help feed the cutter even more!
- 5 required • Rubber extension flaps

Order # K494FLAP

2.3 lbs.

\$25³⁰ ea.



Order # KFLAPBK - Bolt Kit - \$2.65 ea., .55 lbs.

Header Adapters

Economy model earlage adapter

For the farmer that wants to grind a small amount of ear corn.
Fits all Krone® Big X® to JD® corn heads.

Patent # 8,376,126

Order # KR0010

\$3,250⁰⁰ ea.

See us on
YouTube

916 lbs. 

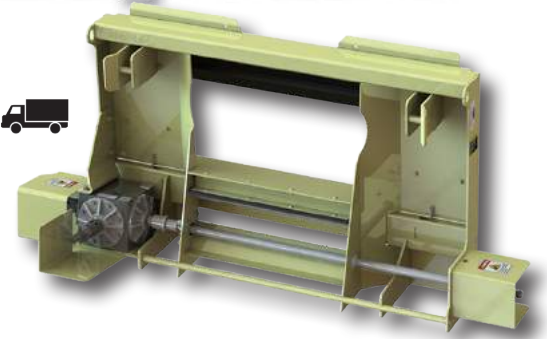

KOOIMA #	PRICE	DESCRIPTION
0332-01490	\$195.75 ea.	• Clamping spline adapter, 1.75-20 to 1.38-6 • 5.2 lbs.
FH002436	\$1,800.00 ea.	• Curtis 615MA Gearbox, 1:1.5, 1.75-20 splines • 170 lbs.
FH002474	\$145.75 ea.	• Shaft, Krone® adapter • 30 lbs.
K302059	\$27.80 ea.	• Replacement gearbox V ring • .5 lbs.
K300459	\$16.00 ea.	• Seal • .05 lbs.
K101527	\$625.80 ea.	• 1 to 1 ratio bevel gear • 21 Tooth • 15.9 lbs.
FH5000952	\$84.45 ea.	• Spline adapter weldment • 3.7 lbs.

Krone® - Claas® Header Adapter

Turn your 492 series Claas® forage harvester into a cutting machine with a 10-row Krone® chopping head on it!
Give us a call for more details. Will also adapt Krone® pick-up heads with minimal modifications. 

Order # KR0020

\$2,500⁰⁰ ea.

Claas® 492 to Krone® head drive line. • 1-3/8 6 spline to 1-3/8 21 spline • 17 3/4" collapsed length • 18.4 lbs.

Order # KR0020PTO492

\$450⁸⁰ ea.



KR0020

Krone® Bi-fold 6000-7500-9000 to Claas® 492 Series Adapter

Order # KR0020

\$2,500⁰⁰ ea.

Order # KRC492

\$250⁷⁵ ea.



KRC492



Krone® Pickup to Claas® 494 Series

Order # KR0020

\$2,500⁰⁰ ea.

Order # KRH494

\$250⁷⁵ ea.

Order # KRH494PTO

\$490⁰⁰ ea.

Order # FH002943

\$175⁰⁰ ea.



KRH494



WARNING - Grinding earlage with the use of corn heads and choppers can cause a risk of fire. The risk of fire does not emanate from the adapter products described on this page, but can be caused by heat generated by the choppers. To reduce the risk of fire, please keep the top of feed roll housing clear of dust. Truck icon signifies product is shipped via truck freight.
Krone® and Big X® are registered trademarks of Bernard Krone Holding, GmbH & Co. KG. John Deere® and JD® are registered trademarks of Deere & Company. Claas® is a registered trademark of Claas KGaA, MBH.

To order toll free: 1-800-522-8874 • By fax: 712-476-6283 • Online: www.kooima.com • E-mail: sales@kooima.com

KOOIMA
COMPANY



Header Adapters

New Style Krone® Adapter

Use this kit along with adapter KR0040 for grinding earlage with your new style wide and narrow throat machines with contour option!

Includes all parts shown (must have or purchase KR0040 adapter)

Order # KRNB35 **\$800⁸⁰ea.**

- Harvester to Gearbox drive shaft
- 1 3/4" 20 spline to 1 3/4" 20 spline
- 2500 series drive pto, 1 required
- Compressed length 39.50"
- Max extended length 54"

Order # KRNB35PTO (Guard not shown for clarity)
\$490.00 ea.

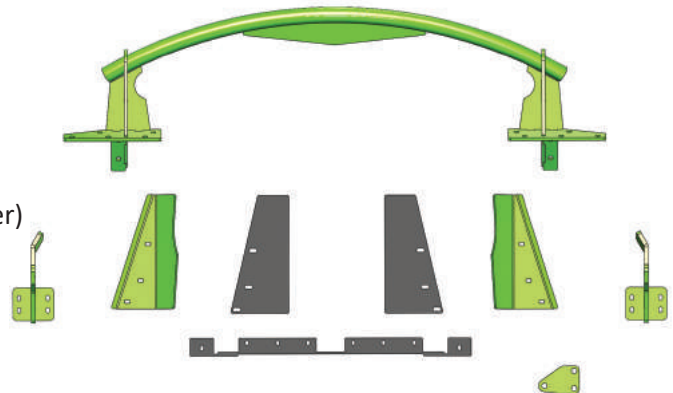

Will also need LH Drive shaft, refer to drive shafts in KR0040 section, page 178.

High Quality Silage Covers

We also carry 6 mil and 8 mil reinforced string tarps, for more information on these go to the front inside cover.



Detail of reinforced string tarps

Prices are subject to change.

Standard Silage Tarps White/Black - 5.0 mil (A5WB1)

Part #	Price	W X L	Weight
K57442	\$108.00	24 X 100	69 lbs.
K57443	\$144.00	32 X 100	90 lbs.
K57628	\$216.00	32 X 150	133 lbs.
K46534	\$180.00	40 X 100	110 lbs.
K57574	\$270.00	40 X 150	163 lbs.
K57575	\$360.00	40 X 200	216 lbs.
K50158	\$225.00	50 X 100	138 lbs.
K50159	\$337.50	50 X 150	203 lbs.
K54235	\$450.00	50 X 200	299 lbs.
K57576	\$270.00	60 X 100	161 lbs.
K53942	\$405.00	60 X 150	255 lbs.
K57577	\$540.00	60 X 200	346 lbs.
K64369	\$2,100.60	60 X 1000	1,557 lbs.
K69881	\$540.00	80 X 150	325 lbs.
K69880	\$720.00	80 X 200	455 lbs.
K70463	\$900.00	80 X 250	561 lbs.
K77059	\$2,800.80	80 X 1000	1,999 lbs.

* Free shipping on Silage Covers if combined with \$750 in Kooima® parts on phone and internet orders

NEW Products at Kooima®

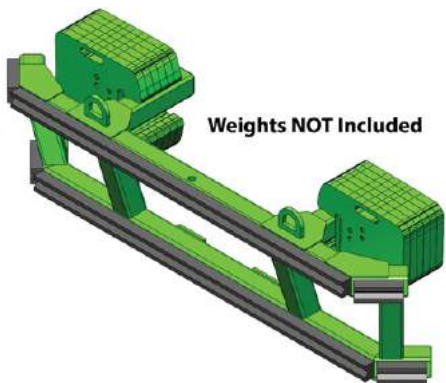

- Tractor bumper (tractor weights not included)
- To fit John Deere® 8000 series tractors

Order # K251JDT

[Call for Pricing](#)



- Single tire mud flap
- To fit ALL tractors with category 3 and 4 three point hook ups

Order # K80MFS

[Call for Pricing](#)

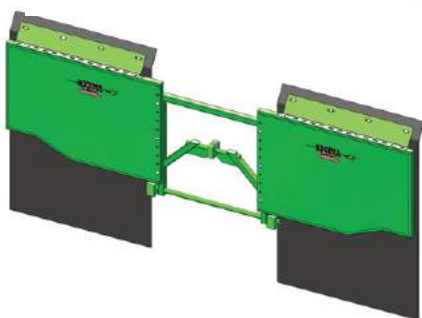

- Dual tire mud flap
- To fit ALL tractors with category 3 and 4 three point hook ups

Order # K80MFD

[Call for Pricing](#)



Round Baler Parts

More parts available at www.kooima.com!

K304576



[Square rod pickup!](#)

K25176



K74678



KOOIMA #
K304576

DESCRIPTION

- Round baler pickup tooth
- To fit round balers with mega pickup heads, 440E, 460M, 446, 447, 448, 449, 450M, 456, 457, 458, 458S, 459, 459SS, 466, 467, 468, 468S, 469, 469P, 469SS, 546, 547, 556, 557, 558, 559, 559SS, 560M, 560R, 566, 567, 568, 569, 569P, 569SS • Also large square balers- L331-L341

REPLACES OEM #

FH304576/E90880/E90881

\$4.75 ea.

K25176

- Pickup tooth • .45 lbs. • **Bolt kit: K25176BK**, \$2.75 ea.

CC25176

\$3.95 ea.

- To fit round balers with wide pickup heads: 435, 446, 456, 466, 582

K74678

- Pickup tooth • .45 lbs. • **Bolt kit: K74678BK**, \$3.50 ea.

E74678

\$2.20 ea.

- To fit round balers: 330, 335, 375, 430, 530, 535



DRIVE LINE COMPONENTS

Order # K023437

- H Frame
- Will work with most 4500 Kemper™ heads
- 2400 series • 4.4 lbs.

\$97⁹⁵ ea.



Order # K019522

- Quick Disconnect Yoke, 1 3/4-20 spline
- 2400 series • 3.7 lbs.

\$89⁴⁵ ea.

Order # K103581

- Quick Disconnect Yoke, 1 3/8-21 spline
- 2400 series • 2.9 lbs.

\$89⁴⁵ ea.

Order # K106271

- Quick Disconnect Yoke, 1 1/2-23 spline
- 2400 series • 3.4 lbs.

\$105⁷⁵ ea.

Order # K320684

- 1 3/8-21 Spline Clamp style yoke • 3.7 lbs.

\$72⁹⁵ ea.

Quality Walterscheid® Parts

2400 Series

Order # K175054

- Yoke, 1 1/8" hex
- Interfering Clamp Style Yoke
- 2400 series • 4 lbs.

\$120⁰⁰ ea.

Order # K368184

- Yoke, 1 1/4" hex
- Interfering Clamp Style Yoke
- 2400 series • 3.6 lbs.

\$97⁹⁵ ea.

Order # K147393

- Yoke, 1 1-2" hex
- Interfering Clamp Style Yoke
- 2400 series • 4 lbs.

\$110⁷⁵ ea.

Order # K136743

- Yoke, 1 3/8" 6 Spline, 540 RPM
- Plastic slide collar yoke
- 2400 series • 3.7 lbs.

\$89⁹⁵ ea.

Order # K136744

- Yoke, 1 3/8" 6 spline, 540 RPM
- Clamp bolt style connection
- 2400 series • 3.3 lbs.

\$85⁰⁰ ea.

Order # K019518

- Male Yoke
- Inboard yoke, 2400 series for 1B size profile • 3.3 lbs.

\$67⁹⁵ ea.

Order # K019519

- Female Yoke
- Inboard yoke, 2400 series for 2A size profile • 3.4 lbs.

\$67⁹⁵ ea.

Order # K312410

- Cross & Bearing Kit
- Cross kit, or U-Joint, 2400 series • 1.4 lbs.

\$65⁴⁵ ea.

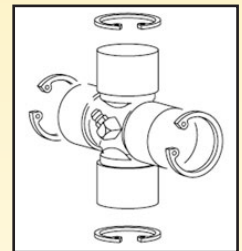

Order # K317582

- Male Tube
- 1B size profile tube, 1500mm long • 14 lbs.

\$72⁹⁵ ea.

Order # K317583

- Female Tube
- 2A size profile tube, 1500mm long • 14.6 lbs.

\$72⁹⁵ ea.

Order # K72150

- PTO, 1 3/8 6 spline to 1 1/2 23 spline chopper
- To fit 6050 & 7000 series cutters to 4500 Kemper™ heads • 2400 series • 15.7 lbs.

\$440⁰⁰ ea.

Order # K64231

- PTO, 1 3/8 6 spline to 1 3/8 21 spline chopper
- To fit 6010 series cutters to 4500 Kemper™ heads
- 2400 series • 16 lbs.

\$440⁰⁰ ea.



Order # KK69888

- PTO, 21 to 21 spline
- To fit JD® 684-686-688 & 710 corn heads • 17.7 lbs.
- Replaces OEM # LCA69888

\$440⁰⁰ ea.

Order # KK73023-21

- Drive Line, 21 to 21 spline
- To fit JD® 676 corn heads
- 15.9 lbs.

\$440⁰⁰ ea.

Order # KK72281

- PTO, 21 to 23 spline
- To fit JD® 684-686-688 & 710 corn heads • 18.8 lbs.
- Replaces OEM # LCA72281

\$440⁰⁰ ea.

Order # KK73023-23

- Drive Line, 23 to 21 spline
- To fit JD® 676 corn heads
- 15.8 lbs.

\$440⁰⁰ ea.

Complete PTO's for your Kemper™ & JD® Heads

DRIVE LINE COMPONENTS

Quality Walterscheid® Parts

2500 Series

Order # K128785

- Quick Disconnect Yoke,
1 1/2-23 spline
- 2500 series • 3.9 lbs.

\$150⁷⁵ ea.



Order # K097315

- Quick Disconnect Yoke,
1 3/4-20 spline
- 2500 series • 4.7 lbs.

\$92⁹⁵ ea.

Order # K396530

- Yoke, 1 1/2" hex
- Interfering Clamp Style Yoke
- 2500 series • 5.3 lbs.

\$97⁹⁵ ea.

Order # K097138

- Quick Disconnect Yoke,
1 3/8-21 spline
- 2500 series • 4.7 lbs.

\$75⁴⁵ ea.

Order # K396965

- Yoke, 1 1/4" hex
- Interfering Clamp Style Yoke
- 2500 series • 4.8 lbs.

\$118²⁵ ea.

Order # K097136

- Yoke, 1 3/8-6 Spline, 540 RPM
- Plastic slide collar yoke
- 2500 series • 4.75 lbs.

\$75⁴⁵ ea.

Order # K102590

- Yoke, 1 1/8" hex
- Interfering Clamp Style Yoke
- 2500 series • 4.8 lbs.

\$140⁷⁵ ea.



Order # K317584

- Male Tube
- S4 size inner profile tube,
1500mm (59") long • 21.6 lbs.

\$190⁷⁵ ea.

Order # K317585

- Female Tube
- S5 size outer profile tube,
1500mm (59") long • 19.5 lbs.

\$140⁷⁵ ea.

Order # K4800049

- Shield to fit **2400 & 2500**
series PTO • 4.7 lbs.
- Cut to length

\$82⁹⁵ ea.



Order # K097133

- Male Yoke
- Inboard yoke, 2500 series
for S4 size profile • 4.9 lbs.

\$69⁴⁵ ea.



Order # K097140

- Female Yoke
- Inboard yoke, 2500 series
for S5 size profile • 4.7 lbs.

\$69⁴⁵ ea.



Order # K023476

- H Frame
- 2500 series • 6.5 lbs.

\$105⁷⁵ ea.

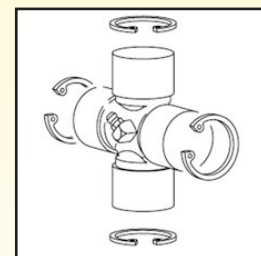

Order # K312209

- Cross & Bearing Kit
- Cross kit, or U-Joint,
2500 series • 2.2 lbs.

\$75⁰⁰ ea.

Drive lines and drive line components pose a safety hazard. Always use proper shielding when installing or using.
Kooima® Company is not liable for misuse or improper operation of components sold.

To order toll free: 1-800-522-8874 • By fax: 712-476-6283 • Online: www.kooima.com • E-mail: sales@kooima.com

KOOIMA
COMPANY



Replacement Mixer Knives

Kooima®



Proudly made
in the U.S.A.

Manufactured By

Kooima® Company has a long history and impeccable reputation for manufacturing a quality product, serving both OEM and after-market ag customers. Our vertical and TMR mixer knives are available in standard or high performance styles.

Standard mixer knives are made of heat treated high carbon steel with a tungsten carbide cutting edge. High performance mixer knives feature Kooima® Company's exclusive patented tungsten carbide insert cutting surface for unsurpassed performance. Our customers prefer Kooima® brand knives, sharper knives save you fuel, time and money. Contact our knowledgeable sales department today and ask how we can save YOU time and money!



AGM™

AGM™ is a trademark of UNIFAST s.r.l., which does not manufacture, distribute or endorse these knives.

REPLACEMENT KNIVES TO FIT AGM™ MIXERS

MIXER KNIFE
Order # **K385015**
7.2 lbs.

- To fit AGM™ vertical mixers
- Tungsten carbide
- Heat treated
- **K385015BK - hardware kit, \$6.50 per blade, .9 lbs.**

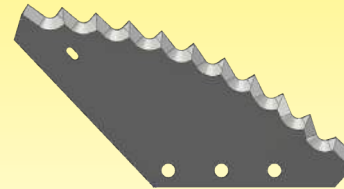

\$96¹⁰
ea.

KNIFE BACKING PLATE
Order # **K385015BP**
9.6 lbs.

- To fit AGM™ vertical mixers
- Abrasion resistant
- Heat treated
- Use with #K385015

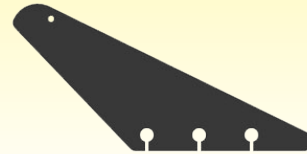

\$48¹⁰
ea.

ART'S-WAY™

Art's-Way™ is a trademark of Art's-Way Mfg. Co. Inc., which does not manufacture, distribute or endorse these knives.

REPLACEMENT KNIVES TO FIT ART'S-WAY™ MIXERS

STANDARD MIXER KNIFE
Order # **K385007**
5 lbs.

- To fit Art's-Way™ vertical mixers
- Heat treated
- **K385007BK - hardware kit (Carriage bolts **Grade 8**) \$7.25 per blade, 1.1 lbs.**
- **KCSBK - hardware kit (Counter-sunk bolts) \$6.60 per blade, .9 lbs.**

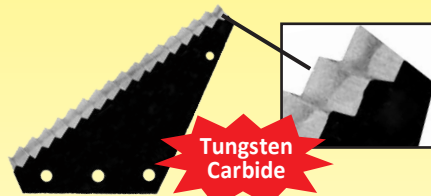

\$80⁴⁰
ea.

HIGH PERFORMANCE MIXER KNIFE
Order # **K385010**
6 lbs.

- Carbide insert style mixer knife
- To fit Art's-Way™ vertical mixers
- Heat treated
- **K385007BK - hardware kit (Carriage bolts **Grade 8**) \$7.25 per blade, 1.1 lbs.**
- **KCSBK - hardware kit (Counter-sunk bolts) \$6.60 per blade, .9 lbs.**



\$159⁰⁰
ea.

KNIFE BACKING PLATE
Order # **K385007BP**
8.7 lbs.

- To fit Art's-Way™ vertical mixers
- Abrasion resistant
- Heat treated

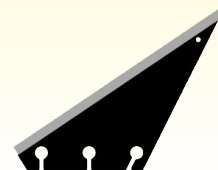

\$56⁵⁰
ea.

Replacement Mixer Knives

Kooima®



Proudly made
in the U.S.A.

Manufactured By

DIAMOND™

Diamond™ is a trademark of Diamond Implements, which does not manufacture, distribute or endorse these knives.

REPLACEMENT KNIVES TO FIT DIAMOND™ MIXERS

STANDARD MIXER KNIFE

Order # K385007

5 lbs.

- To fit Diamond™ vertical mixers
- Heat treated
- K385007BK - hardware kit (Carriage bolts **Grade 8**) \$7.25 per blade, 1.1 lbs.
- KCSBK - hardware kit (Counter-sunk bolts) \$6.60 per blade, .9 lbs.

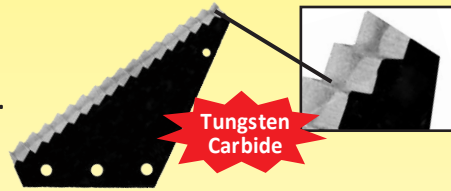

\$80⁴⁰
ea.

HIGH PERFORMANCE MIXER KNIFE

Order # K385010

6 lbs.

- Carbide insert style mixer knife
- To fit Diamond™ vertical mixers
- Heat treated
- K385007BK - hardware kit (Carriage bolts **Grade 8**) \$7.25 per blade, 1.1 lbs.
- KCSBK - hardware kit (Counter-sunk bolts) \$6.60 per blade, .9 lbs.



\$159⁰⁰
ea.

KNIFE BACKING PLATE

Order # K385007BP

8.7 lbs.

- To fit Diamond™ vertical mixers
- Abrasion resistant
- Heat treated



\$56⁵⁰
ea.

HAYBUSTER®

Haybuster® is a registered trademark of DuraTech Industries International, Inc., which does not manufacture, distribute or endorse these knives.

REPLACEMENT KNIVES TO FIT HAYBUSTER® MIXERS

STANDARD MIXER KNIFE

Order # K385007

5 lbs.

- To fit Haybuster® vertical mixers
- Heat treated
- K385007BK - hardware kit (Carriage bolts **Grade 8**) \$7.25 per blade, 1.1 lbs.
- KCSBK - hardware kit (Counter-sunk bolts) \$6.60 per blade, .9 lbs.

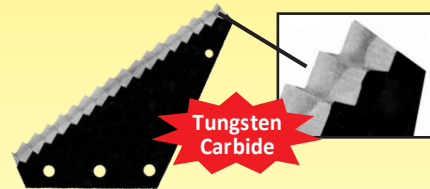

\$80⁴⁰
ea.

HIGH PERFORMANCE MIXER KNIFE

Order # K385010

6 lbs.

- Carbide insert style mixer knife
- To fit Haybuster® vertical mixers
- Heat treated • 6 lbs.
- K385007BK - hardware kit (Carriage bolts **Grade 8**) \$7.25 per blade, 1.1 lbs.
- KCSBK - hardware kit (Counter-sunk bolts) \$6.60 per blade, .9 lbs.



\$159⁰⁰
ea.

KNIFE BACKING PLATE

Order # K385007BP

8.7 lbs.

- To fit Haybuster® vertical mixers
- Abrasion resistant
- Heat treated



\$56⁵⁰
ea.



Replacement Mixer Knives

Kooima®



Proudly made
in the U.S.A.

Manufactured By

JAY-LOR®

JAY-LOR® is a registered trademark of JAY-LOR International Inc., which does not manufacture, distribute or endorse these knives.

REPLACEMENT KNIVES TO FIT JAY-LOR® MIXERS

STANDARD MIXER KNIFE

Order # K385001

3.6 lbs.

Improved!

- To fit JAY-LOR® vertical mixers
- Heat treated / Tungsten carbide
- **New Serrated edge for extreme cutting action!**
- K385002BK - hardware kit, \$4.90 per blade, .7 lbs. **Grade 8**
- K385002BK5 - Free hardware kit per blade, .7 lbs. **Grade 5**



\$84⁷⁵
ea.

HIGH PERFORMANCE MIXER KNIFE

Order # K385002

4.3 lbs.

- HIGH PERFORMANCE carbide insert style
- To fit JAY-LOR® vertical mixers

- K385002BK - hardware kit, \$4.90 per blade .7 lbs. **Grade 8**
- K385002BK5 - Free hardware kit per blade, .7 lbs. **Grade 5**



Lasts 3 Times Longer!

\$159⁰⁰
ea.

KNIFE BACKING PLATE

Order # K385003BP

14.1 lbs.

- 45 degree plate to fit JAY-LOR® vertical mixers
- Abrasion resistant
- Heat treated
- When using this plate, you need 2 bolt kits
- **No Canadian Sales**

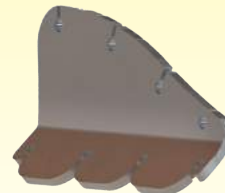

\$62⁹⁵
ea.

MIXER KNIFE

Order # K00004

4.1 lbs.

- To fit JAY-LOR® vertical mixers
- Tungsten carbide
- **No Canadian Sales**
- K00004BK - hardware kit, \$4.25 per blade, .5 lbs.



\$102¹⁰
ea.

KEENAN®

Keenan® is a registered trademark of Richard Keenan & Co., Ltd., which does not manufacture, distribute or endorse these knives.

REPLACEMENT KNIVES TO FIT KEENAN® MIXERS

MIXER KNIFE

Order # K701359 (LH)

Order # K701358 (RH)

1.5 lbs. ea.

- To fit Keenan® horizontal mixers
- Replaces OEM #701359, #701358
- Heat treated / Tungsten carbide
- K701358BK - hardware kit, \$2.10 per blade, .15 lbs.



Left Hand Shown

\$27¹⁰
ea.

Replacement Mixer Knives

Kooima®



Proudly made
in the U.S.A.

Manufactured By

KIRBY™

Kirby™ is a trademark of Kirby Manufacturing, Inc., which does not manufacture, distribute or endorse these knives.

REPLACEMENT KNIVES TO FIT KIRBY™ MIXERS

AGGRESSIVE KNIFE

Order # K1002

6.6 lbs.

- To fit Kirby™ vertical mixers
- Tungsten Carbide / Heat treated
- K385002BK - hardware kit (Grade 8) when using knife in K385003 knife location, \$4.90 per blade, .7 lbs.
- (K385002BK5 - Free hardware kit per blade, .7 lbs. Grade 5)
- K385007BK - hardware kit (Grade 8) when using knife in K385007 knife location, \$7.25 per blade, 1.1 lbs.

Tungsten
Carbide

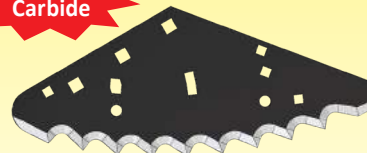

\$96⁵⁰ ea.

KNIFE BACKING PLATE

Order # K1900

10.2 lbs.

- To fit K1002 aggressive knife
- High grade steel construction
- K1900BK - hardware kit, \$6.75 per blade, 1 lb.



\$45⁹⁰ ea.

MIXER KNIFE

Order # K137160

8.25 lbs.

- To fit Kirby™ vertical mixers
- Replaces OEM # 137160
- Heat treated / Tungsten carbide
- K137160BK - hardware kit, \$5.95 per blade 1 lb.

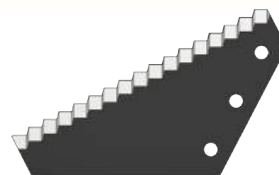

\$96⁵⁰ ea.

STANDARD MIXER KNIFE

Order # K385003

3.6 lbs.

- To fit Kirby™ vertical mixers
- Heat treated / Tungsten carbide
- K385002BK - hardware kit, \$4.90 per blade .7 lbs. Grade 8
- K385002BK5 - Free hardware kit per blade, .7 lbs. Grade 5

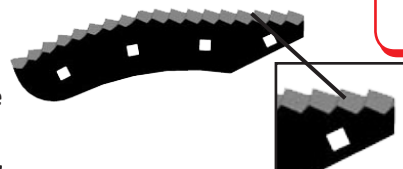

\$80⁴⁰ ea.

KUHN®

Kuhn® is a registered trademark of Kuhn S.A., which does not manufacture, distribute or endorse these knives.

REPLACEMENT KNIVES TO FIT KUHN® MIXERS

TUNGSTEN MIXER KNIFE

Order # K5306460

1.4 lbs.

- TUNGSTEN COATED horizontal mixer knife
- To fit Kuhn® 1460 & Euromix™ 1860 horizontal mixers
- Replaces OEM #A5306460
- Heat treated
- Tungsten carbide
- K5306460BK - hardware kit, \$2.30 per blade

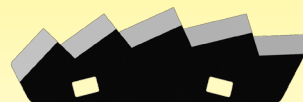

\$20³⁰ ea.

TUNGSTEN MIXER KNIFE

Order # K5310403TC

1.1 lbs.

- TUNGSTEN COATED horizontal mixer knife
- To fit Kuhn® 1460 & Euromix™ 1860 horizontal mixers
- Replaces OEM #A5310403TC
- Heat treated
- Tungsten carbide
- K5306460BK - hardware kit, \$2.30 per blade



\$20³⁰ ea.



QUALITY METAL TOYS, BUILT TO BE PLAYED WITH!

BUY ONLINE: www.RIVERBOTTOMTOYS.com

BOX SCRAPERS



MIXER FEEDER WAGONS



MANURE TANKS



BALE PROCESSORS



CONTACT INFORMATION:
nick@riverbottomtoys.com
Call or Text: 712-470-4954

ALL TOYS ARE 1/16th SCALE

MADE IN ROCK VALLEY IOWA

To order toll free: 1-800-522-8874 • By fax: 712-476-6283 • Online: www.kooima.com • E-mail: sales@kooima.com

KOOIMA®
COMPANY



Replacement Mixer Knives

Kooima®



Proudly made
in the U.S.A.

Manufactured By

KUHN KNIGHT®

Kuhn Knight® is a registered trademark of Kuhn S.A., which does not manufacture, distribute or endorse these knives.

REPLACEMENT KNIVES TO FIT KUHN KNIGHT® MIXERS

VERTICAL MIXER KNIFE

Order # K144734

9.5 lbs.

- To fit Kuhn Knight® vertical mixers
- 20" style
- Heat treated
- Tungsten carbide
- K144734BK - hardware kit, \$3.50 per blade, .95 lbs.

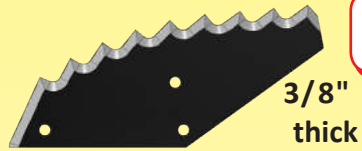

\$93⁴⁵ ea.

HIGH PERFORMANCE VERTICAL MIXER KNIFE

Order # K144734HP

9.5 lbs.

- To fit Kuhn Knight® vertical mixers
- **Now with Koyma Klad® hard facing for even better performance!**
- 20" style
- Heat treated
- Tungsten carbide
- K144734BK - hardware kit, \$3.50 per blade, .95 lbs.



\$139¹⁰ ea.

SHORT TOP MIXER KNIFE

Order # K70147065

7.6 lbs.

- To fit Kuhn Knight® vertical mixers
- 16" style
- Heat treated
- Tungsten carbide
- K144734BK - hardware kit, \$3.50 per blade, .95 lbs.

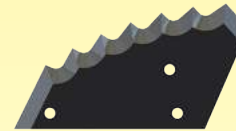

\$64¹⁰ ea.

MIXER KNIFE

Order # K141406

1.35 lbs.

- To fit Kuhn Knight® vertical mixers
- Tungsten carbide
- Heat treated
- K141406BK - hardware kit, \$2.25 per blade, 1 lb.

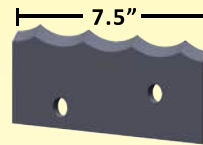

\$37²⁰ ea.

HORIZONTAL MIXER KNIFE

Order # K134351

.16 lbs.

- To fit Kuhn Knight® Reel horizontal mixers
- Replaces OEM #134351
- K134351BK - hardware kit, \$1.40 per blade .95 lbs.



\$3⁵⁰ ea.

HORIZONTAL MIXER KNIFE

Order # K134352

.25 lbs.

- To fit Kuhn Knight® Reel horizontal mixers
- Replaces OEM #134352
- K134351BK - hardware kit, \$1.40 per blade .95 lbs.

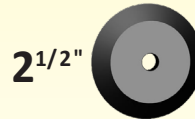

\$3⁹⁰ ea.

HORIZONTAL MIXER KNIFE

Order # K174065 (LH)

Order # K174064 (RH)

1.5 lbs.

- To fit Kuhn Knight® Botec mixers
- To fit Knight™ Commercial Reel mixers
- Heat treated
- Tungsten carbide
- K174064BK - hardware kit, \$3.90 per blade .25 lbs.

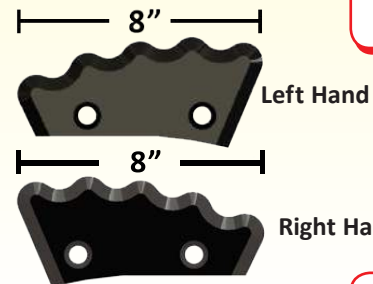

\$23⁷⁵ ea.

HORIZONTAL MIXER KNIFE

Order # K76028480

.5 lbs.

- To fit Kuhn Knight® Reel horizontal mixers
- Replaces OEM #76028480
- 1/4" thick - no need for a backing plate
- K76028480BK - hardware kit, \$2.15 per blade



\$5⁵⁰ ea.

HAY STOP

Order # K70144864

17 lbs.

- To fit Kuhn Knight® vertical mixers
- Replaces OEM # 70144864



\$45³⁵ ea.

NEW!

Replacement Mixer Knives

Manufactured By

Kooima®



Proudly made
in the U.S.A.

LAIRD™

Laird™ is a trademark of Laird Manufacturing Corporation, which does not manufacture, distribute or endorse these knives.

REPLACEMENT KNIVES TO FIT LAIRD™ MIXERS

MIXER KNIFE

Order # **K385015**

7.2 lbs.

- To fit Laird™ vertical mixers
- Heat treated
- Tungsten carbide
- **K385015BK - hardware kit, \$6.50 per blade .9 lbs.**

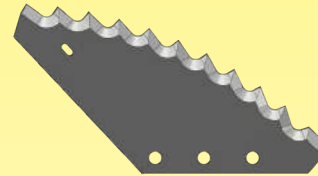

\$96¹⁰
ea.

KNIFE BACKING PLATE

Order # **K385015BP**

9.6 lbs.

- To fit Laird™ vertical mixers
- Abrasion resistant
- Heat treated
- Use with #K385015

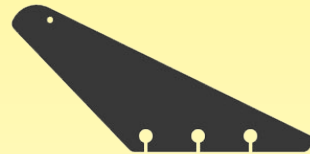

\$48¹⁰
ea.

MIXER KNIFE SECTION

Order # **K122INB**

1.2 lbs.

- To fit Laird™ vertical mixers
- Abrasion resistant/Heat treated
- Inside Knife
- **K111OUTBK - hardware kit, \$3.25 per blade • .2 lbs. (1/2" Bolts)**

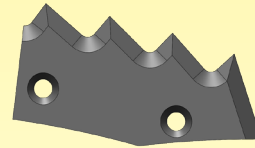

\$46⁹⁰
ea.

MIXER KNIFE SECTION

Order # **K111OUTB**

1.4 lbs.

- To fit Laird™ vertical mixers
- Abrasion resistant
- Heat treated
- Outside Knife
- **K111OUTBK - hardware kit, \$3.25 per blade • .2 lbs. (1/2" Bolts)**

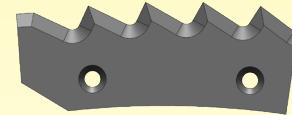

\$46⁹⁰
ea.

SECTION KNIFE BASE

Order # **K60008**

16 lbs.

- To fit Laird™ vertical mixers
- When using K122INB and K111OUTB

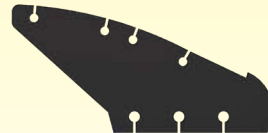

\$46⁹⁰
ea.

STRAIGHT EDGE MIXER KNIFE

Order # **K040380**

6.35 lbs.

- To fit Laird™ vertical mixers
- Heat treated
- Tungsten carbide
- **K385024BK - hardware kit (Carriage bolts Grade 8) \$6.90 per blade, 1.1 lbs.**

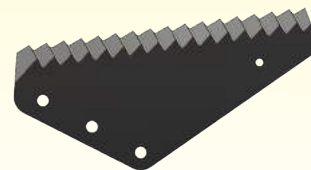

\$76¹⁰
ea.

KNIFE BACKING PLATE

Order # **K040400**

10 lbs.

- To fit Laird™ vertical mixers
- When using knife K040380

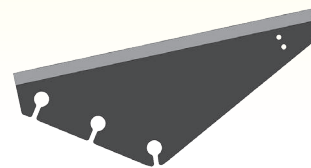

\$37⁸⁵
ea.

LOEWEN™

Loewen™ is a trademark of Loewen Welding & Manufacturing Ltd., which does not manufacture, distribute or endorse these knives.

REPLACEMENT KNIVES TO FIT LOEWEN™ MIXERS

MIXER KNIFE

Order # **K385017**

10.7 lbs.

- To fit Loewen™ vertical mixers
- Heat treated
- Tungsten carbide
- **K385017BK - hardware kit, \$6.75 per blade .95 lbs.**



\$91²⁵
ea.



Replacement Mixer Knives

Kooima®



Proudly made
in the U.S.A.

Manufactured By

MONOMIXER™/MAXIMIXER™

MONOMIXER™/MAXIMIXER™ is a trademark of Sioux Automation Center, Inc., which does not manufacture, distribute or endorse these knives.

REPLACEMENT KNIVES TO FIT
MONOMIXER™/MAXIMIXER™ MIXERS

LEFT HAND MIXER KNIFE

Order # K385012

1.5 lbs.

- To fit all MonoMixer™ horizontal mixers
- Heat treated / Tungsten carbide
- **Improved design is twisted to better conform to flighting**
- K385012BK - hardware kit, \$2.90 per blade .25 lbs.



\$23²⁵ ea.

RIGHT HAND MIXER KNIFE

Order # K385013

1.5 lbs.

- To fit all MonoMixer™ horizontal mixers
- Heat treated / Tungsten carbide
- **Improved design is twisted to better conform to flighting**
- K385012BK - hardware kit, \$2.90 per blade .25 lbs.



\$23²⁵ ea.

HALF MOON MIXER KNIFE

Order # K385014

4.2 lbs.

- To fit all MonoMixer™ horizontal mixers
- Heat treated / Tungsten carbide
- K385014BK - hardware kit, \$3.00 per blade .4 lbs.



\$46³⁵ ea.

STANDARD MIXER KNIFE

Order # K385003

3.6 lbs.

- To fit 3500 series MaxiMixer™ vertical mixers
- Heat treated / Tungsten carbide
- K385002BK - hardware kit, \$4.90 per blade, .7 lbs. (Grade 8)
- K385002BK5 - Free hardware kit per blade, .7 lbs. (Grade 5)



\$80⁴⁰ ea.

STANDARD MIXER KNIFE

Order # K385024

5 lbs.

- To fit Maximixer™ vertical mixers
- **New Serrated edge for extreme cutting action!**
- Abrasion resistant / Heat treated
- KMM58 - hardware kit (Grade 8 bolts) \$6.75 per blade
- K385007BP - backing plate, \$56.50

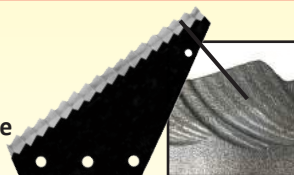

\$80⁴⁰ ea.

Tungsten Carbide

HIGH PERFORMANCE MIXER KNIFE

Order # K385025

6 lbs.

- Carbide insert style mixer knife
- To fit Maximixer™ vertical mixers
- Abrasion resistant, heat treated
- KMM58 - hardware kit (Grade 8 bolts) \$6.75 per blade
- K385007BP - backing plate, \$56.50 ea.



Lasts 3 Times Longer!

\$159⁰⁰ ea.

Counter-sunk 3/8" hole!

PATZ®

PATZ® is a registered trademark of Patz Corporation, which does not manufacture, distribute or endorse these knives.

REPLACEMENT KNIVES TO FIT PATZ® MIXERS

TOP MIXER KNIFE

Order # K21432

6.45 lbs.

- To fit Patz® vertical mixers
- Heat treated / Tungsten carbide
- K385021BK - hardware kit, \$6.75 per blade 1.3 lbs.

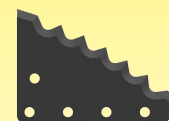

\$98²⁵ ea.

MEDIUM MIXER KNIFE

Order # K21187

10.6 lbs.

* Most commonly used

- To fit Patz® vertical mixers
- Heat treated / Tungsten carbide
- K385021BK - hardware kit, \$6.75 per blade 1.3 lbs.

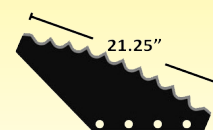

\$125⁷⁵ ea.

MEDIUM KNIFE BACKING PLATE

Order # K21431

6.4 lbs.

- To fit Patz® medium mixer knives
- Hardened steel construction



\$29⁸⁰ ea.

To order toll free: 1-800-522-8874 • By fax: 712-476-6283 • Online: www.kooima.com • E-mail: sales@kooima.com

Replacement Mixer Knives

Kooima®



Proudly made
in the U.S.A.

Manufactured By

PATZ®

PATZ® is a registered trademark of Patz Corporation, which does not manufacture, distribute or endorse these knives.

REPLACEMENT KNIVES TO FIT PATZ® MIXERS

BOTTOM MIXER KNIFE

Order # **K385021**

14 lbs.

- To fit Patz® vertical mixers
- Heat treated / Tungsten carbide
- Only used 1 per auger on the bottom section of auger
- **K385021BK - hardware kit, \$6.75 per blade, 1.3 lbs.**

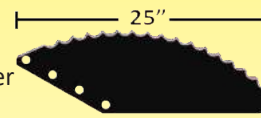

\$132⁵⁰
ea.

HOOK KNIFE

Order # **K28620**

27.5 lbs.

- To fit Patz® vertical mixers
- Heat treated / Tungsten carbide
- **K385021BK - hardware kit, \$6.75 per blade 1.3 lbs.**



\$125⁷⁵
ea.

TOP MIXER KNIFE

Order # **K26289**

6 lbs.

- To fit Patz® vertical mixer knives
- Heat treated / Tungsten Hard-faced
- Install with bevel facing down

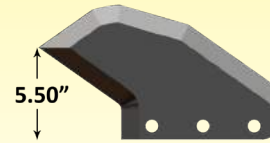

\$75⁴⁵
ea.

TOP MIXER KNIFE

Order # **K385022**

3 lbs.

- To fit Patz® vertical mixer knives
- Heat treated / Tungsten carbide
- Slice through bales quickly
- Install with bevel facing down

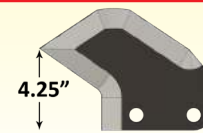

\$35³⁵
ea.

STANDARD MIXER KNIFE

Order # **K385027**

1.3 lbs.

- To fit Patz® horizontal mixers
- Heat treated / Tungsten carbide
- **K385027BK - hardware kit, \$4.20 per blade .25 lbs.**

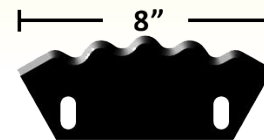

\$21⁸⁰
ea.

PEECON®

Peecon® is a registered trademark of Peeters Landbouwmachines B.V., which does not manufacture, distribute or endorse these knives.

REPLACEMENT KNIVES TO FIT PEECON® MIXERS

SMALL MIXER KNIFE

Order # **K385020**

- To fit Peecon® vertical mixers
- Heat treated / Tungsten carbide
- 1.2 lbs.
- **K385020BK - hardware kit, \$4.50 per blade, .25 lbs.**



\$26⁷⁵
ea.

LARGE MIXER KNIFE

Order # **K385018**

- To fit Peecon® vertical mixers
- Heat treated / Tungsten carbide
- 9 lbs.
- **K385018BK - hardware kit, \$6.50 per blade, .75 lbs.**

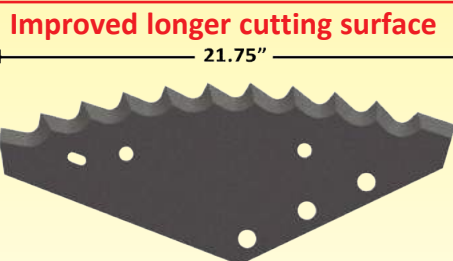

\$94⁷⁵
ea.

KNIFE BACKING PLATE

Order # **K385015BP**

- To fit Peecon® vertical mixers
 - Abrasion resistant
 - Heat treated
 - Use with #K385018
- 9.6 lbs.

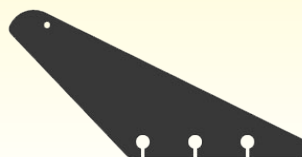

\$48¹⁰
ea.

Replacement Mixer Knives

Kooima®



Proudly made
in the U.S.A.

Manufactured By

PENTA™

Penta™ is a trademark of Penta TMR, Inc., which does not manufacture, distribute or endorse these knives.

REPLACEMENT KNIVES TO FIT PENTA™ MIXERS

STANDARD MIXER KNIFE

Order # K385003

3.6 lbs.

- To fit Penta™ vertical mixers
- Tungsten carbide
- Heat treated
- K385002BK - hardware kit, \$4.90 per blade, .7 lbs. (Grade 8)
- K385002BK5 - Free hardware kit per blade, .7 lbs. (Grade 5)



\$80⁴⁰ ea.

Tungsten Carbide

HIGH PERFORMANCE MIXER KNIFE

Order # K385002

4.3 lbs.

- HIGH PERFORMANCE carbide insert style
- To fit Penta™ vertical mixers
- K385002BK - hardware kit, \$4.90 per blade, .7 lbs. (Grade 8)
- K385002BK5 - Free hardware kit per blade, .7 lbs. (Grade 5)

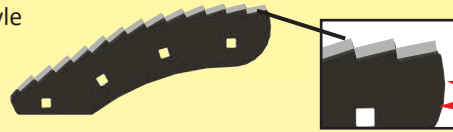

\$159⁰⁰ ea.

Lasts 3 Times Longer!

STANDARD MIXER KNIFE

Order # K385007

5 lbs.

- To fit Penta™ vertical mixers
- Heat treated
- K385007BK - hardware kit (Carriage bolts Grade 8) \$7.25 per blade, 1.1 lbs.
- KCSBK - hardware kit (Counter-sunk bolts) \$6.60 per blade, .9 lbs.

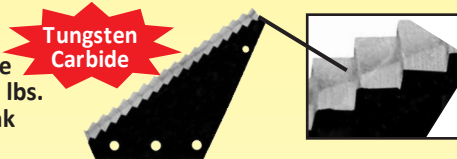

Tungsten Carbide

\$80⁴⁰ ea.

HIGH PERFORMANCE MIXER KNIFE

Order # K385010

6 lbs.

- Carbide insert style mixer knife
- To fit Penta™ vertical mixers
- Heat treated
- K385007BK - hardware kit (Carriage bolts Grade 8) \$7.25 per blade, 1.1 lbs.
- KCSBK - hardware kit (Counter-sunk bolts) \$6.60 per blade, .9 lbs.



Lasts 3 Times Longer!

\$159⁰⁰ ea.

KNIFE BACKING PLATE

Order # K385007BP

8.7 lbs.

- To fit Penta™ vertical mixers
- Abrasion resistant
- Heat treated
- Use with K385007 - K385010



\$56⁵⁰ ea.

HALF MOON MIXER KNIFE

Order # K385014

4.2 lbs.

- To fit Penta™ vertical mixers
- Heat treated, tungsten carbide
- K385014BK - hardware kit, \$3.00 per blade .4 lbs.



\$46³⁵ ea.

BUNDLE & SAVE KIT

Order # KSUPKIT

Patent # 8,186,611

See page 30 for
more details.

- To fit Penta™ vertical mixers
- This kit includes:
 - (2) K385024BIT
 - (1) K385024BODY
 - (1) K385007SU
 - (1) K385024BK
 - (2) K385024BITBK

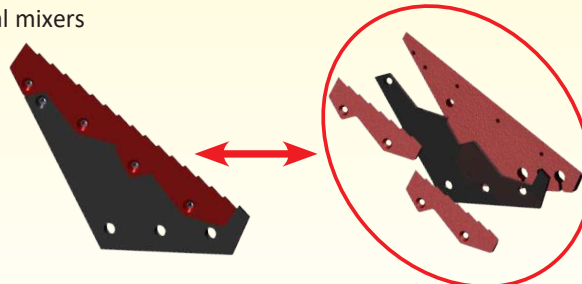

\$147⁹⁰ ea.



Stop throwing half used knives away! Get the most out of your hard-earned dollars with replaceable high quality inserts from Kooima® Company.

Bundle & Save!

Replacement Mixer Knives **Kooima**[®]



Proudly made
in the U.S.A.

Manufactured By

PENTA[™]

Penta[™] is a trademark of Penta One, Ltd., which does not manufacture, distribute or endorse these knives.

REPLACEMENT KNIVES TO FIT PENTA[™] MIXERS

AGGRESSIVE KNIFE

Order # K1002

6.6 lbs.

- To fit Penta[™] vertical mixers
- Tungsten Carbide
- Heat treated
- K385002BK - hardware kit (Grade 8) when using knife in K385003 knife location, \$4.90 per blade, .7 lbs. (K385002BK5 - Free hardware kit per blade, .7 lbs. Grade 5)
- K385007BK - hardware kit (Grade 8) when using knife in K385007 knife location, \$7.25 per blade, 1.1 lbs.

Tungsten
Carbide

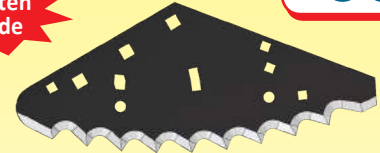

\$96⁵⁰
ea.

KNIFE BACKING PLATE

Order # K1900

10.2 lbs.

- To fit K1002 aggressive knife
- High grade steel construction
- K1900BK - hardware kit, \$6.75 per blade, 1lb.



\$45⁹⁰
ea.

FEED RESTRICTOR

Order # KTA1901

14 lbs.

- To fit Penta[™] TMR
- Replaces OEM # PTA1901



\$30³⁵
ea.

SCHUITEMAKER[™]/ROC[™]

Schuitemaker[™] is a trademark of Schuitemaker Machines B.V., which does not manufacture, distribute or endorse these knives.

REPLACEMENT KNIVES TO FIT SCHUITEMAKER[™]/ROC[™] WAGONS

MIXER KNIFE

Order # K385029

1.9 lbs.

- To fit Schuitemaker[™] & ROC[™] hay box chopping trailer
- Heat treated
- Tungsten carbide

Tungsten
Carbide



\$35¹⁰
ea.

SCHULER[™]

Schuler[™] is a trademark of Schuler Mfg. & Equip. Co. Inc., which does not manufacture, distribute or endorse these knives.

REPLACEMENT KNIVES TO FIT SCHULER[™] MIXERS

MIXER KNIFE

Order # K385023

6.9 lbs.

- To fit Schuler[™] vertical mixers
- Heat treated
- Tungsten carbide
- K385023BK - hardware kit, \$6.50 per blade, 1.05 lbs.

Tungsten
Carbide

3/8"
Thick



\$94⁷⁵
ea.

FEED RESTRICTOR PLATE

Order # K700379

15 lbs.

- To fit Schuler[™] vertical mixers
- Replaces OEM # SCHO-700379

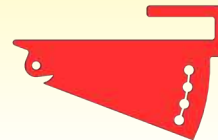

\$45³⁵
ea.

SEKO[™]

Seko[™] is a trademark of Seko SpA., which does not manufacture, distribute or endorse these knives.

REPLACEMENT KNIVES TO FIT SEKO[™] MIXERS

HORIZONTAL MIXER KNIFE

Order # K385045TC

.5 lbs.

- To fit early Seko[™] horizontal mixers
- Tungsten hard-faced for improved performance
- Heat treated / Tungsten carbide
- Replaces OEM #553-04-40-00
- K385045TCBK - hardware kit, \$1.40 per blade •.1 lbs.

Tungsten
Carbide

3 13/16" O.D.

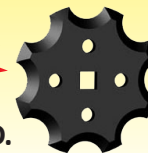

\$24⁷⁵
ea.



Replacement Mixer Knives

Kooima®



Proudly made
in the U.S.A.

Manufactured By

SUPREME™

Supreme™ is a trademark of Supreme International Ltd., which does not manufacture, distribute or endorse these knives.

REPLACEMENT KNIVES TO FIT SUPREME™ MIXERS

STANDARD MIXER KNIFE

Order # K385024

- To fit Supreme™ vertical mixers • 5 lbs.
- **New Serrated edge for extreme cutting action!**
- Abrasion resistant / Heat treated
- K385024BK - hardware kit (Carriage bolts **Grade 8**) \$6.90 per blade, 1.1 lbs.

Improved!

Tungsten Carbide

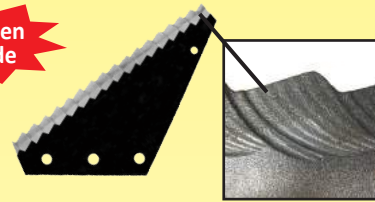

\$80⁴⁰
ea.

HIGH PERFORMANCE MIXER KNIFE

Order # K385025

- Carbide insert style mixer knife
- To fit Supreme™ vertical mixers
- Abrasion resistant, heat treated
- K385024BK - hardware kit (Carriage bolts **Grade 8**) \$6.90 per blade, 1.1 lbs.

6 lbs.



Lasts 3 Times Longer!

\$159⁰⁰
ea.

Counter-sunk
3/8" hole!

KNIFE BACKING PLATE

Order # K385007BP

8.7 lbs.

- To fit Supreme™ vertical mixers
- Abrasion resistant
- Heat treated



\$56⁵⁰
ea.

FEED RESTRICTOR PLATE

Order # KUX067

13.7 lbs.

- To fit Supreme™ vertical mixers
- Replaces OEM # SUPTUX067



\$60⁴⁵
ea.

INNOVATIVE KOOIMA® KNIFE DESIGN!

Lower your mixing costs by using our knives!
Get the most out of your hard-earned dollars with
replaceable high quality inserts from Kooima® Company.

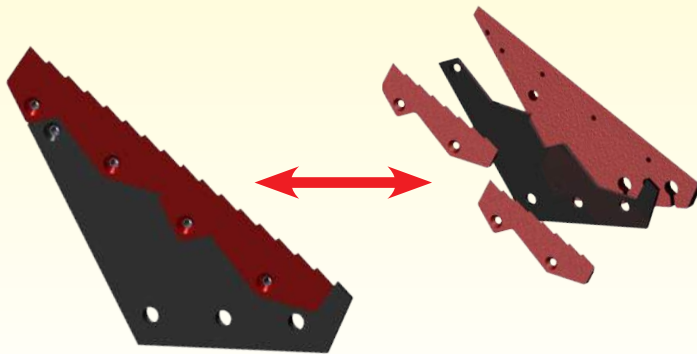

Bundle & Save!
BUNDLE & SAVE KIT
Patent # 8,186,611

Order # KSUPKIT

- This kit includes:
- (2) K385024BIT
- (1) K385024BODY
- (1) K385007SU
- (1) K385024BK
- (2) K385024BITBK

\$147.90 ea.

REPLACEMENT SUPREME™ MIXER BLADE CUTTING EDGE

Order # K385024BIT

- To fit Supreme™ vertical mixers
- **Exclusive Koyma Klad® coating for even longer life**
- Heat treated • 2 required • .9 lbs.
- Patent # 8,186,611
- K385024BITBK - hardware kit, \$2.75 ea. • .1 lbs.



\$31⁷⁵
ea.

REPLACEMENT SUPREME™ MIXER BLADE BODY

Order # K385024BODY

- To fit Supreme™ vertical mixers
- Abrasion resistant
- 1 required • 3.2 lbs.
- K385024BK - hardware kit (**Grade 8**), \$6.90 per blade



\$23²⁵
ea.

REPLACEMENT SUPREME™ BACKING PLATE

Order # K385007SU

- To fit Supreme™ vertical mixers
- Abrasion resistant
- 1 required • 9.6 lbs.

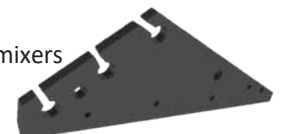

\$56⁵⁰
ea.

Replacement Mixer Knives

Kooima®



Proudly made
in the U.S.A.

Manufactured By

NEW LONGER DISCHARGE KNIFE!

A must for side discharge wagons

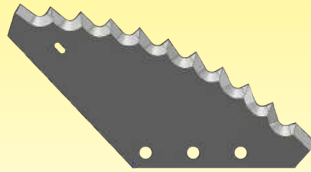
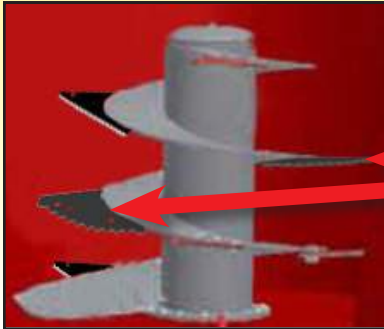

MIXER KNIFE

Order # K385015

- To fit Supreme™ vertical mixers
- Heat treated • Tungsten carbide 7.2 lbs.
- K385007BK - hardware kit (Grade 8), \$7.25 per blade, 1.1 lbs.

**This knife mixes well in the center of the auger!
Do not use in the very top knife position.**

\$96¹⁰
ea.

KNIFE BACKING PLATE

Order # K385015BP

- To fit Supreme™ vertical mixers
- Abrasion resistant • Heat treated • 9.6 lbs.
- Use with #K385015

\$48¹⁰
ea.

TRIOLIET®

Also used on Tatoma® Mixers

Tatoma® is a registered trademark of Grupo Tatoma, SL, which does not manufacture, distribute or endorse these knives. Trioliet® is a registered trademark of Trioliet-Mullos B.V., which does not manufacture, distribute or endorse these knives.

REPLACEMENT KNIVES TO FIT TRIOLIET® MIXERS

SHORT FORMED

MIXER KNIFE

Order # K44100

4.4 lbs.

- To fit Trioliet® vertical mixers
- Replaces short mixer knife • No backing plate needed • Tungsten carbide • Heat treated
- K3814TCBK - hardware kit, \$4.25 per blade, .45 lbs.



\$102⁵⁰
ea.

LONG FORMED

MIXER KNIFE

Order # K05945

- To fit Trioliet® vertical mixers
- Tungsten carbide • Heat treated • 10 lbs.
- K3814TCBK - hardware kit, \$4.25 per blade, .45 lbs.



\$115¹⁰
ea.

SHORT MIXER KNIFE

Order # K3814TC

- To fit Trioliet® vertical mixers
- Heat treated • Tungsten carbide
- Replaces OEM #3814TC • 4.8 lbs.



\$82⁵⁰
ea.

Hardware Kit Numbers: K3814TCBK - w/o backing plate, \$4.25, .45 lbs. K31639TCBK - with backing plate, \$4.25

KNIFE BACKING PLATE

Order # K3814TCBP

- To fit Trioliet® short top knives
- Abrasion resistant • 5.15 lbs.



\$36²⁵
ea.

LONG MIXER KNIFE

Order # K31639TC

6.5 lbs.

- To fit Trioliet® vertical mixers
- Heat treated
- Tungsten carbide
- Replaces OEM #31639TC
- K31639TCBK - hardware kit, \$4.25 per blade, .55 lbs.



\$92¹⁰
ea.

KNIFE BACKING PLATE

Order # K31640

8.4 lbs.

- To fit Trioliet® long knives
- Abrasion resistant



\$46²⁵
ea.

VALMETAL®

Valmetal® is a registered trademark of Valmetal Inc., which does not manufacture, distribute or endorse these knives.

REPLACEMENT KNIVES TO FIT VALMETAL™ MIXERS

STANDARD MIXER KNIFE

Order # K385007

- To fit Valmetal® vertical mixers
- Heat treated • 5 lbs.
- K385007BK - hardware kit (Carriage bolts Grade 8) \$7.25 per blade, 1.1 lbs.
- KCSBK - hardware kit (Counter-sunk bolts) \$6.60 per blade, .9 lbs.

Must use Kooima® backing plates #K385007BP when attaching to Valmetal® mixers



\$80⁴⁰
ea.

HIGH PERFORMANCE MIXER KNIFE

Order # K385010

6 lbs.

- Carbide insert style mixer knife
- To fit Valmetal® vertical mixers
- Heat treated
- K385007BK - hardware kit (Carriage bolts Grade 8) \$7.25 per blade, 1.1 lbs.
- KCSBK - hardware kit (Counter-sunk bolts) \$6.60 per blade, .9 lbs.



\$159⁰⁰
ea.



Kooima® Replacement Manure Hammers

All Kooima® hammers are made using hardened steel.

Don't see your model? Contact us for a quote!

KOOIMA #	PRICE	DESCRIPTION	
K144913 (LH) K144912 (RH) Kuhn Knight®	\$16 ³⁰ ea.	<ul style="list-style-type: none"> To fit Kuhn Knight® vertical beater manure spreaders Hardened steel construction • 1.5 lbs. • Left hand shown Replaces OEM #s 144-912, 144-913, 146-169, 146-170 K144913BK - bolt kit, \$3.75 per paddle, .55 lbs. 	
K141790 Kuhn Knight®	\$9 ²⁰ ea.	<ul style="list-style-type: none"> To fit Kuhn Knight® 1100 & 2000 horizontal manure spreaders Hardened steel • 4.7 lbs. K141790BK - bolt kit, \$3.25 per blade •.38 lbs. 	
K456001 McKee™	\$18 ⁵⁵ ea.	<ul style="list-style-type: none"> To fit McKee™ manure spreaders Hardened steel construction - AR400 • 5.5 lbs. K456001BK - bolt kit, \$3.75 per blade, .5 lbs. 	
K456009 (RH) K456010 (LH) Meyer™	\$9 ⁷⁵ ea.	<ul style="list-style-type: none"> To fit Meyer™ manure spreaders Abrasion Resistant Right hand shown • 1.8 lbs. 	
K456011 Meyer™	\$20 ³⁰ ea.	<ul style="list-style-type: none"> To fit Meyer™ manure spreaders Abrasion Resistant 8.6 lbs. 	
K456008 Meyer™	\$7 ⁷⁵ ea.	<ul style="list-style-type: none"> Straight paddle • To fit Meyer™ manure spreaders Abrasion Resistant 1.8 lbs. 	
K200145 Roda™	\$16 ⁰⁵ ea.	<ul style="list-style-type: none"> To fit Roda™ manure spreaders Tungsten carbide • Hardened steel construction • 1.9 lbs. K200145BK - bolt kit, \$4.25 per blade, .50 lbs. 	
K200146 (LH) K200153 (RH) Roda™	\$19 ⁵⁵ ea.	<ul style="list-style-type: none"> To fit Roda™ manure spreaders Tungsten carbide • Hardened steel construction • 1.7 lbs. K200145BK - bolt kit, \$4.25 per blade, .50 lbs. 	

Kooima® Replacement Composter Paddles

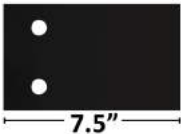
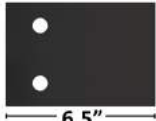
K456014 Sittler®	\$10 ¹⁵ ea.	<ul style="list-style-type: none"> 4" x 6" compost paddle To fit Sittler® composters • 3.2 lbs. High wear AR400 material Bolt kit: K456014BK - 1 required per paddle, \$2.40 ea. 	
K456015 Aeromaster®	\$11 ⁵⁰ ea.	<ul style="list-style-type: none"> Compost paddle • 5.25 lbs. To fit Aeromaster® composters High wear AR400 material Bolt kit: K456014BK - 2 required per paddle, \$2.40 ea. 	
C00289 Kooima® Trner®	\$9 ⁵⁰ ea.	<ul style="list-style-type: none"> Kooima® Trner™ long compost paddle To fit Kooima® Trner® composters • 4.75 lbs. Abrasion resistant • 74 required Bolt kit: C00030BK - 1 required per paddle, \$3.75 ea. 	
C00030 Kooima® Trner®	\$9 ²⁵ ea.	<ul style="list-style-type: none"> Kooima® Trner™ short compost paddle To fit Kooima® Trner® composters • 4.05 lbs. Abrasion resistant • 74 required Bolt kit: C00030BK - 1 required per paddle, \$3.75 ea. 	

Kuhn Knight® is a registered trademark of Kuhn S.A. McKee™ is a trademark of W. McKee Manufacturing Ltd. Meyer™ is a trademark of Meyer Manufacturing Corporation. Roda™ is a trademark of Art's-Way Mfg. Co., Inc. Aeromaster® is a registered trademark of Midwest Bio-Systems Inc. Sittler® is a registered trademark of Global Repair LTD. Trner® is a registered trademark of Kooima Company.

Podemos tomar órdenes en español! : 1-800-522-8874 • By fax: 712-476-6283 • Online: www.kooima.com



John Deere® Flail Knives

- To fit 27, 112, 115, 118 & 120
- Also fits Loftness™ 8023, Buffalo™ 110040, Balzer™ 24153, Mighty Max™ 9001192

Part #	Price	Description
① K6021-875	\$5.00	Flail Knife, 2 1/2" wide, 1 lb.
② K6023-704	\$4.00	D-Ring, .6 lbs.
③ K6024-737	\$4.35	U-Bar, .6 lbs.
5028CH80	\$0.65	1/2 x 1-3/4 Hex Bolt, GR8, .2 lbs.
50NS	\$0.35	1/2 Lock Nut, .04 lbs.

Brillion™ Flail Knives

Part #	Price	Description
① K6021-859	\$4.35	Flail Knife, 2" wide, .6 lbs.
② K6023-700	\$3.35	D-Ring, .55 lbs.
③ K6024-702	\$4.00	U-Bar, 1 lb.

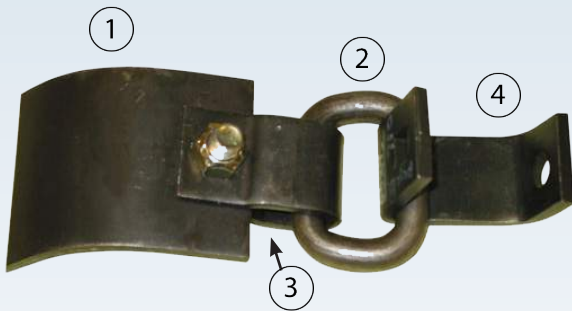

Hiniker® Cup Knives

- To fit 1700, 4000, 5600, 5610, 5620

Part #	Price	Description
① KFK79431	\$6.75	Cup Knife, 3" wide, .8 lbs.
①a KFK79431HP	\$13.00	Cup Knife, 3" wide, .9 lbs. Hard-faced Edge
② K6023-502	\$4.00	D-Ring, .45 lbs.
③ KFP65227	\$5.00	U-Bar, .5 lbs.
④ K6024-710	\$3.05	Pivot, .45 lbs.
5024C5	\$0.55	1/2 x 1-1/2 Carr Bolt, GR5, .11 lbs.
50NS	\$0.35	1/2 Lock Nut, .04 lbs.

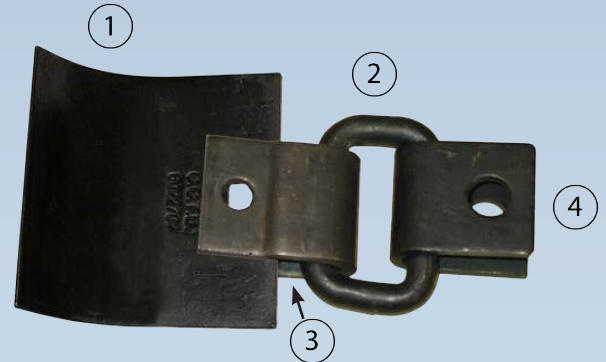

Loftness™ Cup Knives

- To fit Loftness™ 8022

Part #	Price	Description
① K6022-702	\$8.95	Cup Knife, 4 1/2" wide, Hard Faced Edge , 1.4 lbs.
② K6023-503	\$3.50	Square Ring, .55 lbs.
③ K6024-704	\$5.10	U-Bar Long, .7 lbs.
④ K6024-744	\$4.50	U-Bar Short, .6 lbs.
5024C5	\$0.55	1/2 x 1-1/2 Carr Bolt, GR5, .11 lbs.
50NS	\$0.35	1/2 Lock Nut, .04 lbs.



Brillion™ & Balzer™ Cup Knives

- To fit Balzer™ & Brillion™

Part #	Price	Description
① K6022-718	\$4.35	Cup Knife, 2 1/2" wide, .85 lbs.
② K6023-502	\$4.00	D-Ring, .45 lbs.
③ K6024-743	\$5.00	U-Bar, .5 lbs.
④ K6024-710	\$3.05	Pivot, .45 lbs.
5024C5	\$0.55	1/2 x 1-1/2 Carr Bolt, .11 lbs.
50NS	\$0.35	1/2 Lock Nut, .04 lbs.
⑤ KFK18205	\$8.00	5" long, 2 1/2" wide, curled eye Replaces Art's Way™ No. 18205-0 Replaces Balzer™ No. 24237 Replaces Sukup® No. J8250 1.5 lbs.

John Deere® is a registered trademark of Deere & Company. Loftness™ is a trademark of Loftness Manufacturing. Buffalo™ is a trademark of Bison Industries, Inc. Balzer™ is a trademark of Balzer Inc. Mighty Max™ is a trademark of Vrisimo Equipment Company, Valley Tool & Mfg. Brillion™ is a trademark of Brillion Farm Equipment, Landoll Corporation. Hiniker® is a registered trademark of Hiniker Company. Art's-Way™ is a trademark of Art's-Way Mfg. Co., Inc. Sukup® is a registered trademark of Sukup Manufacturing Co.



Kooima® Replacement Parts To Fit JOHN DEERE®

KOOIMA® REPLACEMENT PARTS TO FIT 5000 SERIES JOHN DEERE® FORAGE HARVESTERS

John Deere® and JD® are registered trademarks of Deere & Company, which does not manufacture, distribute or endorse these parts.

Replacement parts produced by Kooima® Company to fit JD® 5000 Series

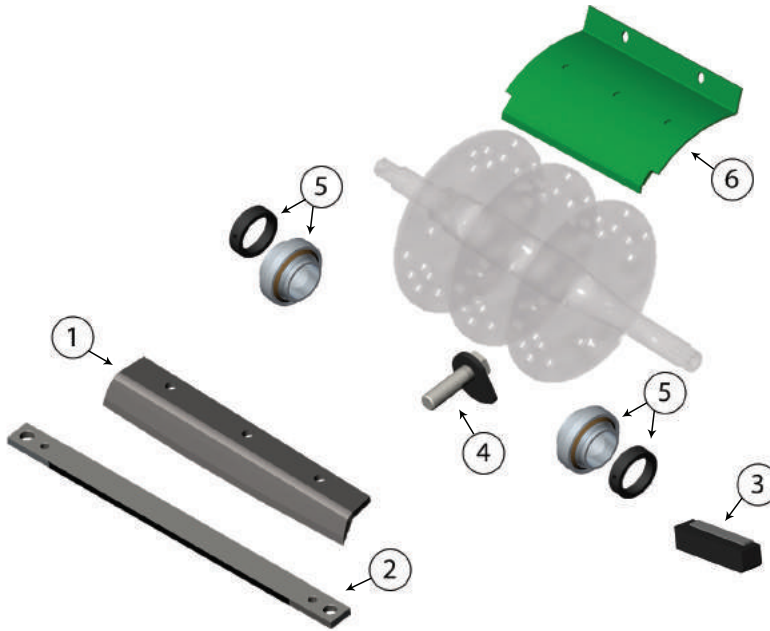

KOOIMA #	DESCRIPTION	REPLACES OEM #
K73179 \$96.50 ea.	① J-knife • To fit 5000 series with J-knife cutterhead • 9 required • 9.1 lbs.	E73179 Heat Treated Tungsten Carbide
K56369 \$107.00 ea.	② Shearbar • To fit 5000 series with J-knife cutterhead • 11.8 lbs.	E56369 Tungsten Carbide
K56369BK \$50.35 ea.	②a Bolt kit • To fit K56369 • .85 lbs.	
K22635 \$53.00 ea.	③ Sharpening stone • To fit early 5000 series with J-knife cutterhead • 2 lbs.	AE22635
K32487 \$12.00 ea.	④ Knife bolt with cam • To fit 5000 series with J-knife cutterhead • 27 required • .65 lbs.	AE32487
K49020 \$58.00 ea.	⑤ Cutterhead bearing • To fit all 5200, 5400 and early 5440 and 5460's equipped with factory J-knife cutterhead or Kooima® conversion • Includes locking collar • 2 required • Fits shaft with 2.44" OD • 3.7 lbs.	AE49020
K35338 \$140.00 ea.	⑥ Cutterhead door • To fit all 5000 series with J-knife cutterhead housings • 30 lbs.	AE35338 Abrasion Resistant

SEGMENTED KNIFE CUTTERHEAD CONVERSIONS

Convert your John Deere® J-knife drum to a multi-knife cutterhead!

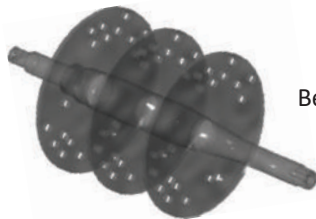

Before



After

1/2" thick center support inside drum helps eliminate center cracking

KOOIMA #
5400CON (w/o knives & hardware)
\$3,525.00
K5400CON (complete w/knives and mounting hardware)
\$4,450.00

DESCRIPTION

- Requires up to 20% less horsepower! • Increase production as much as 25%!
- Chop more tons per hour with greater fuel efficiency! • Substantial savings on knife replacements! • Full one year warranty from date of purchase! • 478 lbs. 

Truck icon signifies product is shipped via truck freight.

FREE FREIGHT ON RETAIL ORDERS OVER \$750.00!

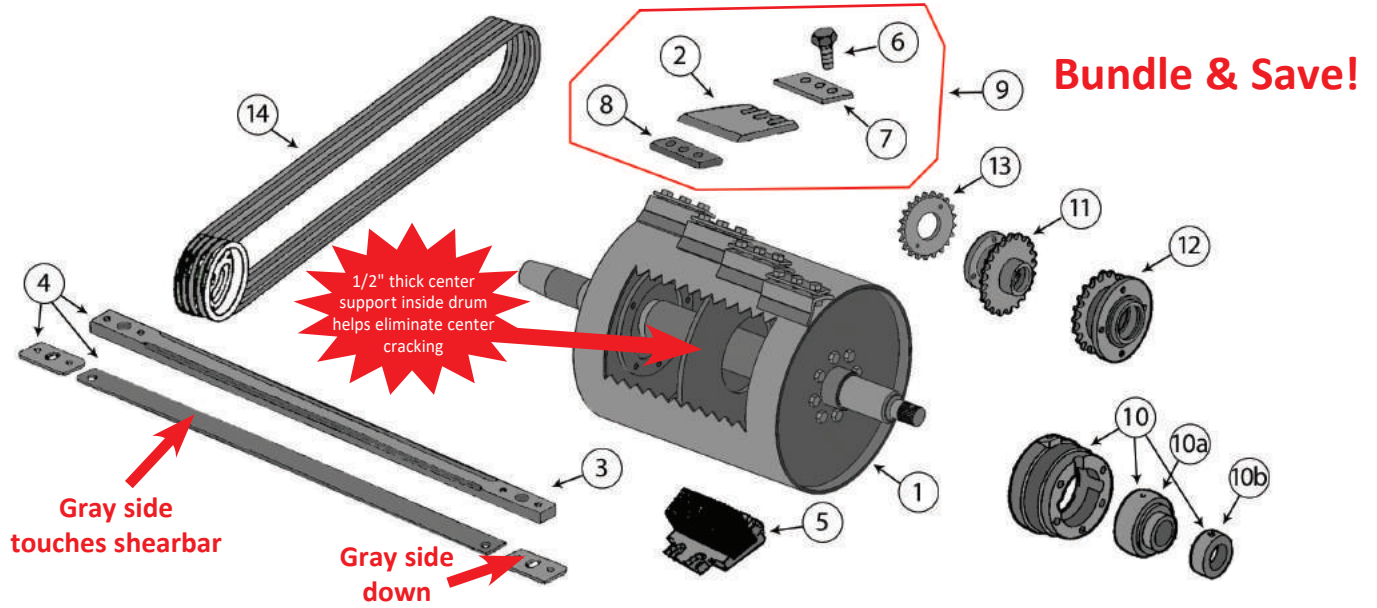

KOOIMA #	DESCRIPTION	REPLACES OEM #
5800CON (w/o knives & hardware) \$3,550.00	1 • Replacement cutterhead assembly • Heavier than OEM drum wall • Bolt-in replaceable shaft • 479 lbs.	AE45060
K5800CON (complete w/knives and mounting hardware) \$4,475.00		
K66678 \$11.75 ea.	2 • Knife • To fit all 5000 series with factory Dura-drum™ cutterhead • 40 required • 1lb.	FH310958 / E66678 Heat Treated/ Tungsten Carbide
K66678HP \$16.25 ea.	2a • Hi-performance knife • 1lb. • Thicker tungsten carbide edge than the standard knife	FH310958 / E66678 Heat Treated / Tungsten Carbide
K72919 \$215.00 ea.	3 • Shearbar • 18 lbs. • To fit all 5000 series with factory Dura-drum™ cutterhead	AE44466 / E72919 Tungsten Carbide
K44466 \$240.00 ea.	4 • Shearbar kit • Gray side of wear strip always touching shear bar • Includes wear strip and bearings • 19 lbs.	AE44466 Tungsten Carbide
K44466BK \$30.00 ea.	4a • Bolt kit • To fit K44466 • 1.4 lbs.	
K46064 \$47.00 ea.	5 • Sharpening stone • To fit all 5000 series with factory Dura-drum™ cutterhead • 2.6 lbs. • Hardware Kit: K46064BK , \$2.65 ea., .20 lbs.	AE46064
K71444 \$1.95 ea.	6 • Knife bolt • Improved head • One of the strongest bolts on the market today • 120 required • .2 lbs.	E83035/E71444
K66536 \$6.10 ea.	7 • Top strap • To fit 5000 series Dura-drum™ cutterhead • 40 required • .6 lbs.	FH312489/E66536 Heat Treated
K66537 \$7.10 ea.	8 • Nut • To fit 5000 series Dura-drum™ cutterhead • 40 required • .7 lbs.	E66537
K66678KIT \$29.25 ea.	9 • Buy (1) K66678, (1) K66536, (1) K66537, (3) K71444 • Buy any quantity and save! • 3 lbs. for 1 kit	
K38694 \$395.00 ea.	10 • Cutterhead bearing and casting assembly • To fit 5000 series equipped with factory Dura-drum™ • Includes bearing and locking collar • 2 required • 22 lbs. • Bolt kit: K38694BK , \$8.00 ea., 2.35 lbs.	AE38694
K9307 \$157.75 ea.	10a • Cutterhead bearing • To fit 5000 series equipped w/ factory Dura-drum™ cutterhead housing • 2 required • Fits shaft with 2.94" OD • 6.3 lbs. ea.	JD9307
K9308 \$20.80 ea.	10b • LH locking collar • To fit 5000 series equipped w/ factory Dura-drum™ cutterhead housing • 2 required • 1.3 lbs. ea.	JD9308
K36839 \$95.45 ea.	11 • Inside cutterhead & feed roll drive coupler • To fit 5000 series equipped with factory Dura-drum™ cutterhead housing • 1 required • 4.1 lbs.	AE36839
K35842 \$225.75 ea.	12 • Outside cutterhead & feed roll drive coupler • To fit 5000 series equipped with factory Dura-drum™ cutterhead housing • 1 required • 7.95 lbs.	AE35842
K48610 \$21.80 ea.	13 • Auger box drive sprocket • 21 tooth • To fit all 5000 series • 1 required • 1.85 lbs.	E48610
K45931 \$175.75 ea.	14 • Drum belt (set of 3) • Fits all 5000 series machines • 12.75 lbs. per set	AE45931

KOOIMA® REPLACEMENT PARTS TO FIT 5000 SERIES JOHN DEERE® FORAGE HARVESTERS

Replacement parts produced by Kooima® Company to fit JD® 5000 Series



KOOIMA #	DESCRIPTION	REPLACES OEM #
K40698 \$185.75 ea.	① • Cutterhead door • To fit all 5000 series with factory Dura-drum™ cutterhead housings • 44.3 lbs. • Hardware Kit: K40698BK, \$72.45	AE40698 Abrasion Resistant
K66518 \$125.75 ea.	② • Cutterhead door • To fit all 5000 series with factory Dura-drum™ cutterhead housings • 29 lbs.	FH304071 / E66518 Abrasion Resistant
K38618 \$56.35 ea.	③ • Cutterhead support • 16.5 lbs. • To fit all 5000 series with factory Dura-drum™ cutterhead housings • Hardware Kit: K38618BK, \$8.25, 1 lb.	AE38618 Abrasion Resistant
K35570 \$49.35 ea.	④ • Cutterhead shield • To fit all 5000 series with factory Dura-drum™ cutterhead housings • 11.7 lbs.	AE35570 Abrasion Resistant

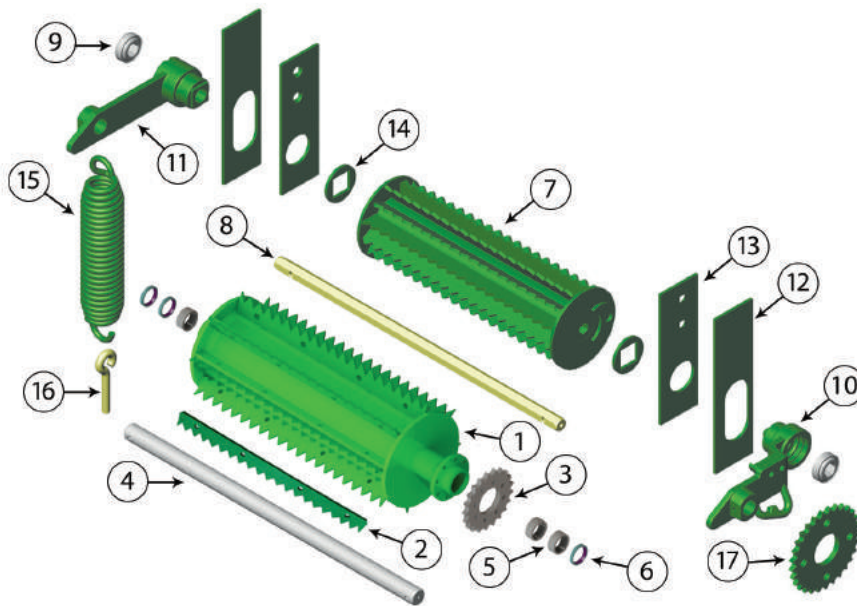

KOOIMA #	DESCRIPTION	REPLACES OEM #
K43635 ⑤ \$865.00 w/o teeth and bearings \$1,110.00 with teeth and bearings	• Feed roll, upper front • To fit all 5000 series with metal detector • A Kooima® Company exclusive! • Straight bar design is more aggressive in corn and cane • Complete with bolt-on teeth and bolt-on sprocket • 59.2 lbs. w/o teeth	AE43635 Stainless Steel
K43635T ⑤a \$36.85 ea.	• Tooth, upper front feed roll • To fit #K43635 feed roll • 8 required • 18.1 lbs./set	Stainless Steel
K43635FT ⑤b \$35.35 ea.	• Flat replaceable tooth • To fit #K43635 feed roll • Eliminates wrapping in haylage • 8 required • 19.2 lbs./set	Stainless Steel
K43635TBK ⑤c \$22.30 ea.	• Hardware kit for K43635T & K43635FT • To fit all 5000 series • 2 lbs.	

KOOIMA® REPLACEMENT PARTS TO FIT 5000 SERIES JOHN DEERE® FORAGE HARVESTERS

Replacement parts produced by Kooima® Company to fit JD® 5000 Series

KOOIMA #	DESCRIPTION	REPLACES OEM #
K00016WW 5	<ul style="list-style-type: none"> Feed roll, upper front • To fit all 5000 series without metal detector Straight bar design is more aggressive in corn and cane Complete with bolt-on teeth, bolt-on sprocket & bearings 62 lbs. w/o teeth 	AE43198
\$590.80 ea.		
K00015WW 5d	<ul style="list-style-type: none"> Bolt-on tooth • To fit Kooima® roll # K00016WW non-metal detector feed roll • 8 required • 1.85 lbs. ea. 	Abrasion Resistant
\$29.30 ea.		
K43635S 5e	<ul style="list-style-type: none"> Sprocket Bolt-on To fit either style upper front feed roll 1.7 lbs. 	
\$39.35 ea.		
K72037 6	<ul style="list-style-type: none"> Shaft • To fit either upper front feed roll K43635 or K00016WW 30-1/2" long; 1-3/8" diameter • 13.1 lbs. 	E72037 Heat Treated
\$105.75 ea.		
K9865 7	<ul style="list-style-type: none"> Bearing, upper front feed roll • To fit all 5000 series 3 required • .2 lbs. 	JD9865
\$10.00 ea.		
K53699 8	<ul style="list-style-type: none"> Seal, upper front feed roll To fit all 5000 series • 3 required • .1 lbs. 	E53699
\$4.00 ea.		
K37101 9	<ul style="list-style-type: none"> Feed roll, upper rear Heavy duty end plates MORE AGGRESSIVE DESIGN To fit all 5000 series 47.2 lbs. 	AE37101 Abrasion Resistant
\$405.80 ea.		
K72352 10	<ul style="list-style-type: none"> Shaft • To fit upper rear feed roll K37101 • To fit all 5000 series 29-7/8" x 1" hex shaft • 7.2 lbs. 	E72352 Heat Treated
\$40.35 ea.		
K9438 11	<ul style="list-style-type: none"> Feed roll lift arm bearing 1 required per arm • .6 lbs. 	JD9438/AFH202185
\$28.55 ea.		
K40254 12	<ul style="list-style-type: none"> Left hand feed roll lift arm Includes bearing 8.5 lbs. 	E66228 / AE40254
\$235.75 ea.		
K40253 13	<ul style="list-style-type: none"> Right hand feed roll lift arm Includes bearing 8.95 lbs. 	E66040 / AE40253
\$180.75 ea.		
K72817 14	<ul style="list-style-type: none"> Support strap, upper rear feed roll To fit all 5000 series • 2 required • 3.2 lbs. 	E72817 Abrasion Resistant
\$35.35 ea.		
K72818 15	<ul style="list-style-type: none"> Support strap, upper rear feed roll To fit all 5000 series • 2 required • 3 lbs. 	E72818 Abrasion Resistant
\$26.80 ea.		
K55609 16	<ul style="list-style-type: none"> Washer, upper rear feed roll To fit all 5000 series • 2 required • .3 lbs. 	E55609 Heat Treated
\$8.25 ea.		
K64796 17	<ul style="list-style-type: none"> Rear feed roll lift arm spring • To fit all 5000 series with factory Dura-drum™ cutterhead housing • 2 required • 12 lbs. 	Z67236 / E64796
\$63.45 ea.		
K82550 18	<ul style="list-style-type: none"> Eyebolt • Use with feed roll lift arm spring above 2 required • .6 lbs. 	E82550
\$13.80 ea.		
K48604 19	<ul style="list-style-type: none"> Upper feed roll drive slip clutch sprocket To fit all 5440 and 5460 harvesters & 5720, 5730, 5820 & 5830 SN. 740000 and before • 38 tooth • 6.95 lbs. 	E48604 Heat Treated
\$30.35 ea.		
K75928 19a	<ul style="list-style-type: none"> Upper feed roll drive slip clutch sprocket To fit all 5440 and 5460 harvesters & 5720, 5730, 5820 & 5830 SN. 740001 and after • 6.65 lbs. • Hardware kit: K75928BK, \$5.55 ea. 	E75928
\$54.00 ea.		

KOOIMA® REPLACEMENT PARTS TO FIT 5000 SERIES JOHN DEERE® FORAGE HARVESTERS

Replacement parts produced by Kooima® Company to fit JD® 5000 Series

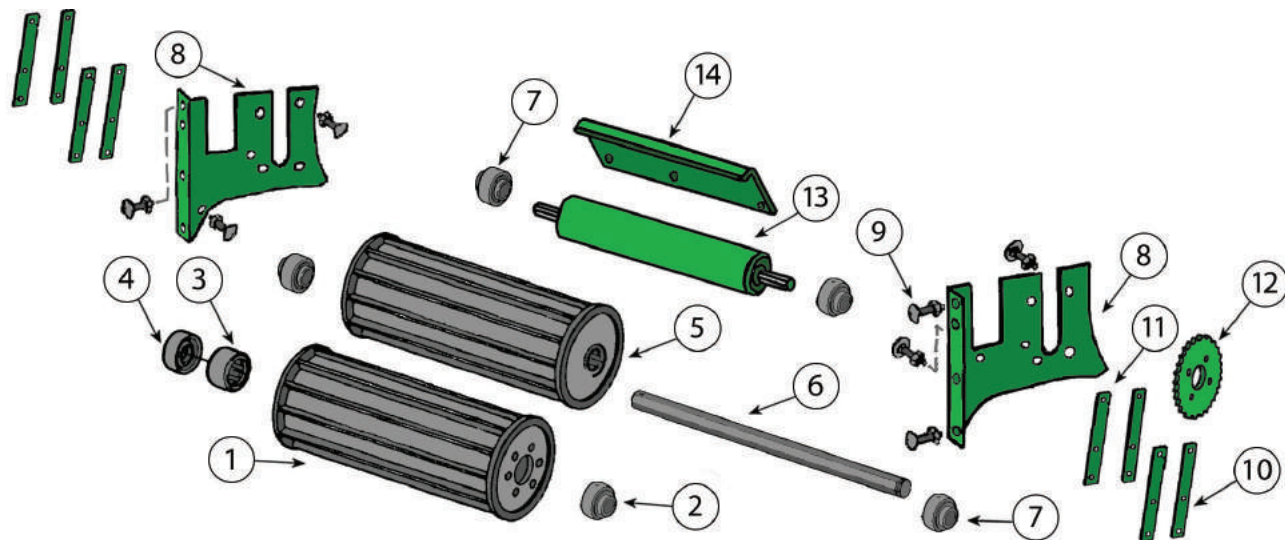

KOOIMA #	DESCRIPTION	REPLACES OEM #
K42646 ① \$995.80 ea.	<ul style="list-style-type: none"> • Feed roll, lower front • Stainless steel • To fit 5000 series with metal detector • 43.7 lbs. • Bolt kit: K42646BK, \$19.25 ea. 	AE42646 Stainless Steel
K42697 ② \$74.45 ea.	<ul style="list-style-type: none"> • Bearing, lower front feed roll • To fit all 5000 series with metal detector • 1 required • 1.3 lbs. 	AE42697
K9865 ③ \$10.00 ea.	<ul style="list-style-type: none"> • Bearing for lower front feed roll • To fit all 5000 series with metal detector • 2 required • .3 lbs. 	JD9865
K53699 ④ \$4.00 ea.	<ul style="list-style-type: none"> • Seal, lower front feed roll • To fit all 5000 series with metal detector • 2 required • .1 lbs. 	E53699
K35423 ⑤ \$315.80 ea.	<ul style="list-style-type: none"> • Lower front feed roll • To fit all early 5000 series with 1" hex shaft • Complete with replaceable, abrasion resistant crossbars & hardware • 50.8 lbs. w/o teeth 	AE35423
K37327 ⑤a \$315.80 ea.	<ul style="list-style-type: none"> • Lower front feed roll • To fit all late 5000 series without metal detector with 1-1/4" hex shaft • 47.1 lbs. w/o teeth • Complete with replaceable, abrasion resistant crossbars & hardware 	AE44164 / AE37237
K37328 ⑤b \$13.30 ea.	<ul style="list-style-type: none"> • Replaceable, abrasion resistant crossbars • To fit roll #K37327 and #K35423 • 8 required • 15.3 lbs. per 8 pc. set 	Abrasion Resistant
K35424 ⑥ \$55.35 ea.	<ul style="list-style-type: none"> • Lower front feed roll shaft • To fit early 5000 series • Use with feed roll #K35423 • 27-1/8" x 1" hex shaft • 6.6 lbs. 	Heat Treated
K64565 ⑥a \$60.00 ea.	<ul style="list-style-type: none"> • Lower front feed roll shaft • To fit late 5000 series without metal detector • Use with feed roll #K37327 • 27-9/16" x 1-1/4" hex shaft • 10.4 lbs. 	E64565
K9407 ⑦ \$16.30 ea.	<ul style="list-style-type: none"> • Bearing, 1" hex bore • To fit lower front feed rolls in early 5000 series without metal detector • 2 used per roll • .6 lbs. 	JD9407
K49017 ⑦a \$60.45 ea.	<ul style="list-style-type: none"> • Bearing, 1-1/4" hex bore • To fit lower front feed roll in all late 5000 series without metal detector • 2 required • 1.1 lbs. 	AE49017
K38057 (Left) K38058 (Right) ⑧ \$49.35 ea.	<ul style="list-style-type: none"> • Wear plate • Made of high carbon steel • To fit all 5000 series with factory Dura-drum™ cutterhead housings • 6.4 lbs. ea. 	AE38057 AE38058 Abrasion Resistant Tungsten Carbide
K38057BK ⑨ \$14.95 ea.	<ul style="list-style-type: none"> • Hardware kit • Includes all hardware necessary to install both right and left feed roll wear plates • 1 kit required • 2.8 lbs. 	

KOOIMA® REPLACEMENT PARTS TO FIT 5000 SERIES JOHN DEERE® FORAGE HARVESTERS

Replacement parts produced by Kooima® Company to fit JD® 5000 Series

KOOIMA #	DESCRIPTION	REPLACES OEM #
K68041 \$7.40 ea.	⑩ • Support strap • To fit all 5000 series • 4 required • .6 lbs.	E68041
K71283 \$6.25 ea.	⑪ • Support strap • To fit all 5000 series • 12 required • .6 lbs.	E71823
K48605 \$35.35 ea.	⑫ • Lower feed roll drive slip clutch sprocket • To fit all 5200, 5400, 5440, 5460 harvesters & 5720, 5820, 5730 & 5830 harvesters SN. 740000 & before • 29 tooth • 1 required • 3.7 lbs. • Bolt kit: K48605BK , \$9.25 ea. 2.5 lbs.	E48605 Heat Treated
K37068 ⑬ \$145.75 ea.	 • Smooth feed roll, lower rear • To fit early 5000 series with 1" hex shaft • Uses shaft #K62133 • 24 lbs.	AE37068
K62133 ⑬a \$40.35 ea.	 • Shaft, smooth feed roll • To fit early 5000 series with replaceable 1" hex shaft • 27-3/4" x 1" hex shaft • 6.6 lbs.	E62113
K42180 ⑬b \$275.75 ea.	 • Smooth feed roll, lower rear • To fit 5440 and 5460 with factory Dura-drum™ cutterhead before 1984 • Extra heavy, thick wall tube • Complete with 1-1/4" hex shaft • 49.5 lbs.	AE42180 
K50029 ⑬c \$295.75 ea.	 • Smooth feed roll, lower rear • To fit 5720 & 5820 series and all 5730 & 5830 series • Extra heavy, thick wall tube • Complete with 1-1/4" hex shaft • 49.6 lbs.	AE50029 / AE44370 
K48802 \$45.35 ea.	⑭ • Smooth roll cleaner • To fit all 5000 series • 6 lbs. • K48802BK - Bolt kit, \$13.00 ea., .45 lbs.	E48802 Heat Treated
K5000WSC \$100.75 ea.	 • Windshield cover • 11 lbs. • To fit all 5000 series harvesters • Eliminates cracked and broken windshields • Double sewn heavy duty, padded vinyl construction • Stainless steel dee rings	





1 lb.

The Rock Stop'er Pro

FORAGE HARVESTER STONE DETECTION SYSTEM



JD® must have double spring kit installed.

- Fits most makes and models of SPFH and pull type harvesters.
- Patented Inertia sensor stops feed drive when rocks are detected.
- In cab sensitivity adjustment for varying crop conditions.
- Call **1-800-522-8874** for more details!

Extra Sensor Available!

Order # SENSOR
Only \$750⁸⁰ ea.

Order # ROCK STOPER
Only \$2,950⁰⁰ ea.



Designed and manufactured in Canada.

TO ORDER CALL TOLL FREE 1-800-522-8874

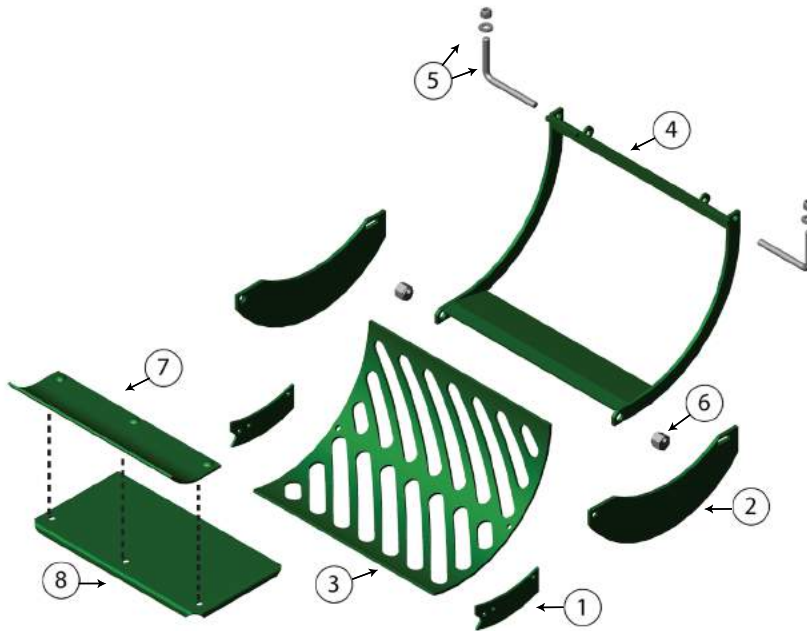

KOOIMA #	DESCRIPTION	REPLACES OEM #
K63418 \$13.20 ea.	① • Wear plate • 2 required • 1.5 lbs. • To fit all 5000 series • Hardware Kit: K63418BK , \$4.25, .27 lbs.	E63418 Abrasion Resistant
K65299 (Right) K65300 (Left) \$43.85 ea.	② • Recutter screen support • To fit all 5000 series • 1 each required • 9.9 lbs. ea. • Hardware Kit: K65299BK , \$9.50 ea., .35 lbs.	E65299 E65300 Abrasion Resistant
K49803 K49804 K49753 \$160.75 ea.	③ • 3/4" recutter screen • 29.5 lbs. • 1" recutter screen • 28 lbs. • 1-1/2" recutter screen • 25 lbs. • To fit all 5000 series	E49803 E49804 E49753 Abrasion Resistant
K35574 \$198.25 ea.	④ • Recutter screen frame • 20.5 lbs. • To fit all 5000 series • Hardware Kit: K35574BK , \$50.35 ea.	AE35574
K61790 \$19.80 ea.	⑤ • Recutter screen bolt and nut assembly • To fit all 5000 series • 2 required • 1 lb.	AE30957 E61790
K64299C \$12.25 ea.	⑥ • Recutter screen adjusting cam • To fit all 5000 series • 2 required • .45 lbs.	E64229
K38127 \$79.45 ea.	⑦ • Lower feed roll pan • Front panel used when grinding ear corn • To fit all 5000 series • 11.2 lbs. • Hardware Kit: K38127BK , \$2.65 ea., .15 lbs.	AE38127 Abrasion Resistant
K63534 \$54.35 ea.	⑧ • Lower feed roll pan • Rear panel used when grinding ear corn • To fit all 5000 series • 14.4 lbs.	E63534 Abrasion Resistant

ROTARY SCREEN ASSEMBLY

Keep your harvester running cool with a

Kooima® Rotary Screen!

- Keeps radiators cleaner
- Engine runs cooler and more efficiently
- Complete with mounting hardware
- To fit all **5000** series harvesters **except 5440**
- 185 lbs.

Order # K5000RS

Only
\$4,050⁰⁰ ea.



Truck icon signifies product is shipped via truck freight.

Podemos tomar órdenes en español! : 1-800-522-8874 • By fax: 712-476-6283 • Online: www.kooima.com

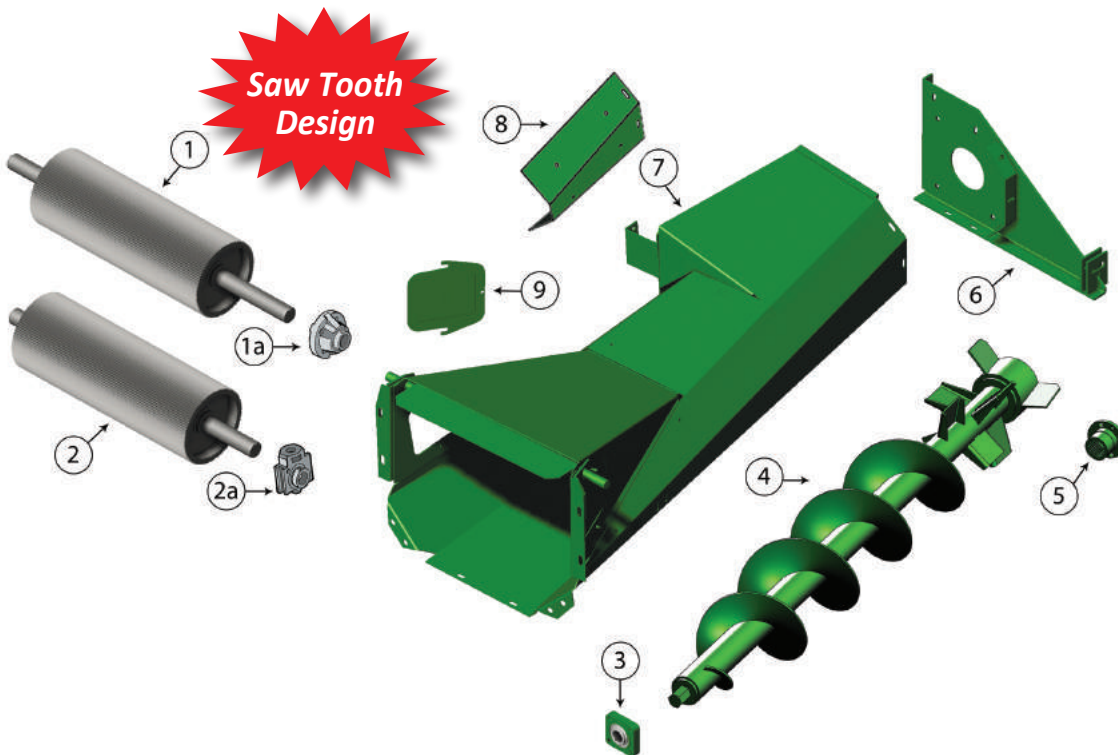

KOOIMA #	DESCRIPTION	REPLACES OEM #
K46198 \$1,170.00 ea.	① • Upper kernel processor roll • To fit 5000 series with factory kernel processor attachment • 130.5 lbs.	AE46198 Heat Treated
K46565 \$145.00 ea.	①a • Upper kernel processor bearing • To fit all 5000 series cutters • 2 required • 5.6 lbs.	AE46565
K46199 \$1,170.00 ea.	② • Lower kernel processor roll • To fit all 5000 series with factory kernel processor attachment • 134 lbs.	AE46199 Heat Treated
K45398 \$145.00 ea.	②a • Lower kernel processor bearing • To fit all 5000 series cutters • 2 required • 3.7 lbs.	AE45398
K42460 \$110.75 ea.	③ • Bearing assembly • Includes cast housing and bearing • 1 required • 2.8 lbs. • Bolt kit: K42460BK, \$2.65 ea., .25 lbs.	AE42460
K45495 \$750.80 ea.	④ • Kernel processor auger • To fit 5000 series equipped with factory John Deere® kernel processors • 1 required • 72.5 lbs.	AE45495
K73996 \$195.00 ea.	⑤ • Splined drive hub • 1 required • K73996BK: Drive hub bolt kit, \$3.75 ea.	E73996
K42176 \$92.95 ea.	⑥ • Rear support • To fit 5000 series equipped with factory John Deere® kernel processors • 1 required • 21.2 lbs. • Hardware kit: K42176BK, \$14.00 ea.	AE42176
K42157 \$995.80 ea.	⑦ • Kernel processor housing • To fit all 5000 series equipped with factory John Deere® kernel processors • 1 required • 152 lbs.	AE42157
K42157LIN \$69.45 ea.	⑧ • Replacement processor housing liner • 1 required • 5 lbs.	
K45967 \$20.30 ea.	⑨ • Clean out door • 2 required • 3.8 lbs. • Hardware kit: K45967BK, \$1.35 ea., .05 lbs.	AE45967 Abrasion Resistant

K38618HP



\$915.00 ea.

- Cracker plate
- To fit 5000 series
- Cracks 85-90% of kernels with minimal power requirements
- Bolt-in installation
- No moving parts to maintain
- Use in whole plant corn silage or to grind earlage
- Patent #6,234,072 & #6,327,970 • 30.8 lbs.



KOOIMA® REPLACEMENT PARTS TO FIT 5000 SERIES JOHN DEERE® FORAGE HARVESTERS

Replacement parts produced by Kooima® Company to fit JD® 5000 Series

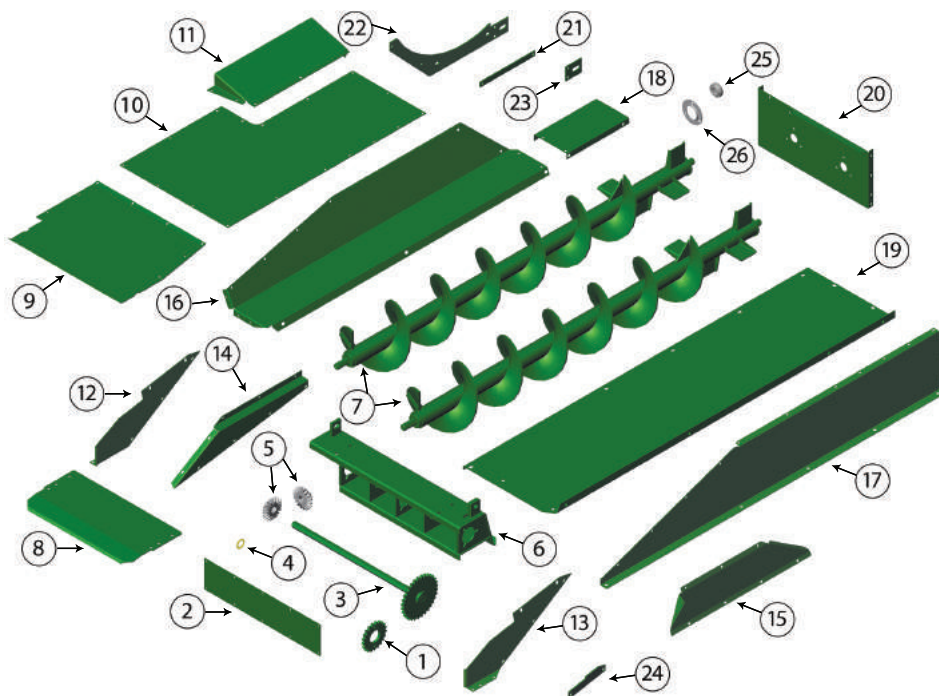

	<u>KOOIMA #</u>	<u>DESCRIPTION</u>	<u>REPLACES OEM #</u>
1	K48610	\$21.80 ea. • Auger box drive sprocket • 21 tooth • 1 required • 1.85 lbs.	E48610
2	K67112	\$26.05 ea. • Double auger box front panel • 5.4 lbs.	E67112
3	K37997	\$120.00 ea. • Double auger box drive shaft • 12.95 lbs.	AE37997
4	K24H1477	\$17.80/pack • Double auger box shim washers • Package of 20 shims • .1 lbs./20 pcs.	24H1477
5	K63258	\$63.95 ea. • Double auger box drive gear • 4 required • 1.9 lbs. • Heat Treated	E63258
6	K40530	\$300.80 ea. • Double auger box front housing • 35 lbs.	AE40530
7	K33741	\$560.80 ea. • Auger assembly • 2 required • 90 lbs.	AE33741
8	K58313	\$58.10 ea. • Auger box wear plate • 11.6 lbs.	E58313
9	K59886	\$73.95 ea. • Auger box top panel • 23.4 lbs. • Abrasion Resistant	E59886
10	K56075	\$64.45 ea. • Auger box top panel • 25 lbs.	E56075
11	K56383	\$39.85 ea. • Auger box discharge ramp top • 6.8 lbs.	E56383
12	K58254	\$31.85 ea. • Double auger box right front panel • 4.6 lbs.	E58254
13	K58255	\$31.85 ea. • Double auger box left front panel • 4.6 lbs.	E58255
14	K49755	\$23.40 ea. • Double auger box right mid panel • 3 lbs.	E49755
15	K56549	\$40.60 ea. • Double auger box left mid panel • 6.4 lbs.	E56549
16	K56079	\$85.45 ea. • Double auger box right side panel • 29 lbs.	E56079
17	K63910	\$94.95 ea. • Double auger box left side panel • 26 lbs.	E63910
18	K63908	\$21.30 ea. • Double auger box discharge ramp • 4.1 lbs.	E63908
19	K63911	\$120.75 ea. • Double auger box bottom panel • 59 lbs.	E63911
20	K63909	\$50.35 ea. • Double auger box end panel • 10.9 lbs.	E63909
21	K48545	\$8.00 ea. • Double auger box strap • .6 lbs.	E48545
22	K48543	\$64.45 ea. • Double auger reinforcement strap • 3.8 lbs.	E48543
23	K50622	\$7.50 ea. • Double auger box plate • 2 required • .4 lbs.	E50622
24	K52452	\$7.10 ea. • Double auger box axle plate • .75 lbs.	E52452
25	K9407	\$16.30 ea. • Double auger box bearing • 7 required • .6 lbs.	JD9407
26	K54498	\$4.00 ea. • Double auger box bearing flange • 10 required • 4 lbs.	E54498

K46315

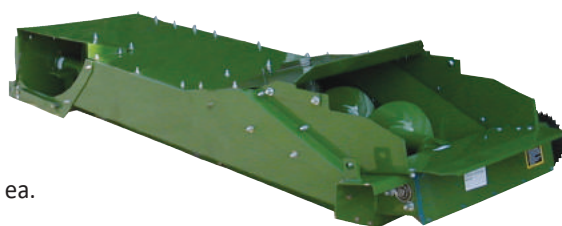

\$2,925.00 ea.

- Double auger box assembly
- Complete auger box includes augers, gears and drive shaft
- **Timed and ready to install**
- To fit all 5000 series
- 550 lbs.

AE46315

Abrasion Resistant

Truck icon signifies product is shipped via truck freight.

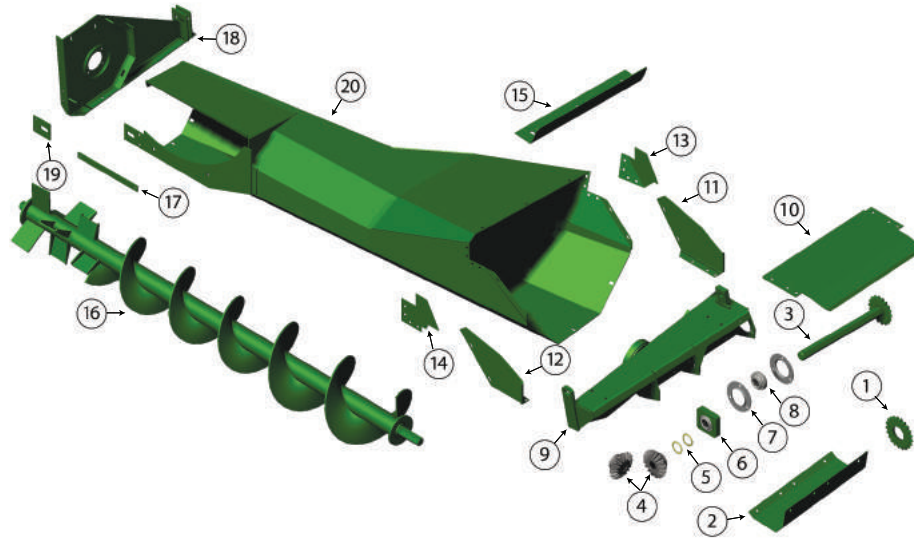

KOOIMA #	DESCRIPTION	REPLACES OEM #
① K48610	\$21.80 ea. • Auger box drive sprocket • 21 tooth • 1 required • 1.9 lbs.	E48610
② K72528	\$22.30 ea. • Auger box front cover • 4.3 lbs.	E72528
③ K24490	\$110.00 ea. • Auger box drive shaft • 7.9 lbs. • Heat Treated	DA24490
④ K24430	\$93.95 ea. • Auger box drive gear • 2 required • 3.8 lbs. • Heat Treated	CA24430
⑤ K24H1534	\$17.80/pack • Single auger box shim washer • Package of 20 shims • .1 lbs./20 pcs.	24H1534
⑥ K42460	\$110.75 ea. • Bearing assembly, w/ cast housing & bearing • 3 req'd. • 2.8 lbs. • Bolt kit: K42460BK, \$2.65 ea.	AE42460
⑦ K135410	\$3.10 ea. • Single auger box flange • 2 required • .4 lbs.	H135410
⑧ K37057	\$49.85 ea. • Single auger box hex bearing • 1 required • 1 lb.	AE37057
⑨ K43925	\$400.80 ea. • Single auger box front housing • 39.9 lbs.	AE43925
⑩ K24857	\$50.35 ea. • Single auger box top panel • 10.3 lbs.	CA24857
⑪ K71687	\$20.30 ea. • Single auger box left side panel • 2.4 lbs.	E71687
⑫ K71688	\$20.30 ea. • Single auger box right side panel • 2.8 lbs.	E71688
⑬ K71686	\$15.30 ea. • Single auger box left side panel • 1 lb.	
⑭ K71689	\$12.25 ea. • Single auger box right side panel • 1 lb.	
⑮ K43929	\$20.30 ea. • Single auger box front angle plate • 4.9 lbs.	
⑯ K44941	\$725.80 ea. • Auger assembly • 104.5 lbs.	AE44941
⑰ K48545	\$8.00 ea. • Single auger box strap • .6 lbs.	E48545
⑱ K43926	\$110.75 ea. • Single auger box rear support • 18.6 lbs.	AE43926
⑲ K50622	\$7.50 ea. • Single auger box support plate • .4 lbs.	E50622
⑳ K44727	\$955.80 ea. • Single auger box main housing • 143 lbs.	AE44727

K43928



- Single auger box assembly
- Complete with auger, drive shaft and bevel gears
- Moves feed faster and more efficiently
- **Ready to install**
- To fit all 5000 series harvesters
- 402 lbs.

AE43928

\$2,990.00 ea.

K5000WS



- Power wind chute
- Auger box replacement
- Replaces both single and double auger boxes
- No machine modification necessary
- Requires up to 15% less horsepower
- No power loss due to augers
- Chop more tons per hour with greater efficiency
- Heavy duty **abrasion resistant** construction
- **For use in corn or cane only** • 285 lbs.

AE43928

AE46315

\$1,700.00 ea.

TO ORDER CALL TOLL FREE 1-800-522-8874



KOOIMA® REPLACEMENT PARTS TO FIT 5000 SERIES JOHN DEERE® FORAGE HARVESTERS

Replacement parts produced by Kooima® Company to fit ID® 5000 Series

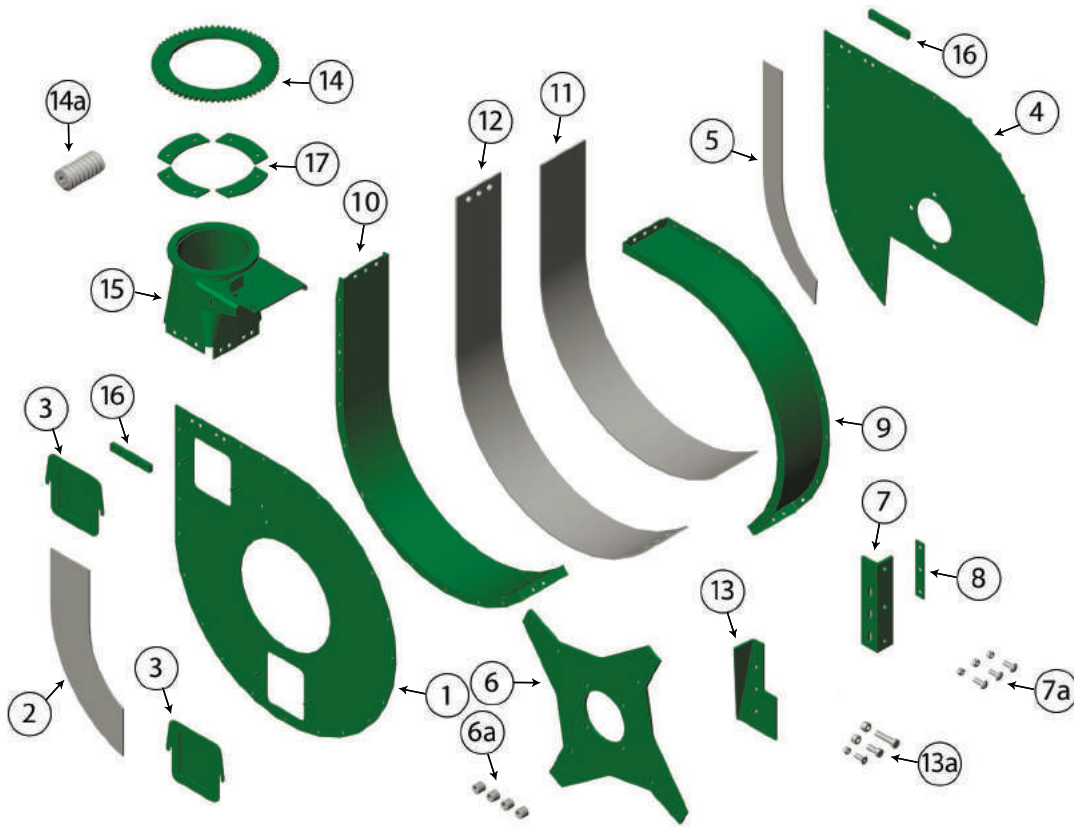

KOOIMA #		DESCRIPTION	REPLACES OEM #
K35950 \$148.75 ea.	①	• Outside fan sheet • To fit all 5000 series • 37.8 lbs.	AE35950 Abrasion Resistant
K35951 \$50.35 ea.	②	• Outside fan wear plate • Weld-in • To fit all 5000 series • Increases the life of outside fan sheet • 7.1 lbs.	Abrasion Resistant
K45967 \$20.30 ea.	③	• Outside fan sheet inspection doors • 2 required • To fit all 5000 series • 3.8 lbs. • Hardware kit: K45967BK , \$1.35 ea., .05 lbs.	AE45967 Abrasion Resistant
K28998 \$150.75 ea.	④	• Inside fan sheet • To fit all 5000 series • 38.3 lbs.	AE28998 Abrasion Resistant
K28999 \$37.85 ea.	⑤	• Inside fan wear plate • Weld-in • 4.6 lbs. • To fit all 5000 series • Increases the life of inside fan sheet	Abrasion Resistant
K49027HP \$157.75 ea.	⑥	• High performance fan plate • Made of tool steel for impact resistance • To fit all 5000 series • Extra fan angle bolt hole provides additional angle support • Requires 4 #K55571HP angles to complete • 30 lbs.	E49027
K29167 \$8.75 ea.	⑥a	• Fan plate bushing • 4 required • .2 lbs.	H29167
K55571HP \$17.30 ea.	⑦	• High performance fan angle • To fit #K49027HP • Mounting hardware available • 5.3 lbs.	E55571
K55571BK \$18.30 ea.	⑦a	• Hardware kit • Includes all necessary hardware to mount #K49027HP fan plate and #K55571HP fan angles • 1 required • 2.8 lbs.	
K55570 \$5.25 ea.	⑧	• Fan strap • Standard bore • .4 lbs.	E55570
K36535 \$99.45 ea.	⑨	• Front blower band • To fit all 5000 series • Newer heavy duty style • 3/16 in. thick material • One of the most durable blower bands on the market • 22.8 lbs.	AE36535 Abrasion Resistant
K78174 \$135.00 ea.	⑩	• Rear blower band • To fit all 5000 series • Newer heavy duty style • 3/16 in. thick material • One of the most durable blower bands on the market • 28 lbs.	E78174 Abrasion Resistant
KFANW \$85.00 ea.	⑪	• Rear blower band liner • Weld-in • To fit all 5000 series • Increases the life of the rear blower band • 26.3 lbs.	Abrasion Resistant
KFANB \$95.00 ea.	⑫	• Rear blower band liner • Bolt-in • To fit all 5000 series • Hardware included • Increases the life of the rear blower band • 31.2 lbs.	Abrasion Resistant

KOOIMA® REPLACEMENT PARTS TO FIT 5000 SERIES JOHN DEERE® FORAGE HARVESTERS

Replacement parts produced by Kooima® Company to fit JD® 5000 Series

KOOIMA #	DESCRIPTION	REPLACES OEM #
K33650 \$19.80 ea.	⑬ • Fan paddle, long (12" long) • Used for corn or hay • To fit all 5000 series • 4.1 lbs.	AE33650 Abrasion Resistant Heat Treated
K33650BK \$12.85 ea.	⑬a • Bolt kit for fan paddles • To fit long or short paddles • One kit contains enough bolts and nuts for 4 paddles and fan straps • 2 lbs.	
K56053 \$148.25 ea.	⑭ • Spout ring gear • Made of high carbon steel • 9.4 lbs. • To fit all 5000 series • Hardware Kit: K56053BK , \$11.25, 1.33 lbs.	E56053
K73207 \$240.75 ea.	⑭a • Spout worm gear • To fit 5720, 5820, 5730 and 5830 • 1 required • 4.3 lbs. • 1" bore all the way through	E73207 Heat Treated
K45920 \$345.80 ea.	⑮ • Spout transition • To fit all 5000 series • 26.3 lbs.	AE45920
K45920BK \$29.80 ea.	⑮a • Spout transition bolt kit • To use with K45920 transition • 1 kit required • 2 lbs.	
K74168 \$18.30 ea.	⑯ • Strap, spout transition • To fit all 5000 series • 2 required • .7 lbs. • Hardware kit: K74168BK , \$13.30 ea., 1 kit required per strap	E74168
K58022 \$14.30 ea.	⑰ • Plate, spout transition • To fit all 5000 series • 4 required • .9 lbs.	E58022

K44648

\$610.80 ea.

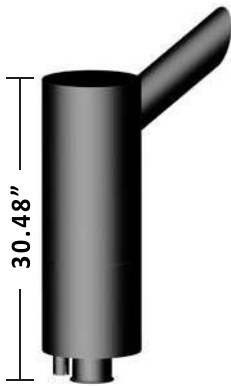

- Muffler
- To fit all 5820, 5830 & 5440 series harvesters
- 45.5 lbs.
- Replaces OEM # AE44648
- **Hardware Kit: K44648BK** \$51.35 ea., 1.2 lbs.



K48788BR

\$95.45 ea.



- Rear rubber bumper
- 13.75" long • 2 required
- To fit 5000 series
- Replaces OEM #: Z48788/E51240

HAY PICK-UP TEETH

HP hay pick-up teeth are "shot peened," giving them added strength!

- Pick-up tooth • .45 lbs.
- To fit all John Deere® 630, 645, 630A, 640A, 645A, 630B, 640B, 645B, 630C, 640C & 645C forage harvester hay heads
- Replaces OEM #CC25176

Order # K25176

\$3⁹⁵ ea.

Order # K25176HP

\$5³⁵ ea.

Bolt Kit: K25176BK: \$2.75 ea.



- Pick-up tooth
- To fit all John Deere® 5 1/2 ft. forage heads
- Replaces OEM #268SE
- .35 lbs.

Order # K268SE

\$2⁰⁵ ea.

Bolt Kit: K268SEBK: \$4.25 ea.



- Pick-up tooth • .45 lbs.
- To fit all John Deere® 7 1/2 ft. forage harvester hay heads after SN. 550001
- Replaces OEM #E74678

Order # K74678

\$2²⁰ ea.

Bolt Kit: K74678BK: \$3.50 ea.



- Poly Pick-up stripper - Complete with hardware
- 1/2" thick with 1/4" thick reinforced support ring
- To fit John Deere® 630A, 640A, 645A, 630B, 640B, 645B, 630C, 640C & 645C hay heads • 1.2 lbs.
- Replaces OEM # FH311772 / E85043

Order # K85043

\$30²⁵ ea.

Additional Bolt Kit: K85043BK \$3.50 ea. One required per band

Order online at WWW.KOOIMA.COM and receive **FREE FREIGHT** to your door!

KOOIMA®
COMPANY





45

KOOIMA® REPLACEMENT PARTS TO FIT 5000 SERIES JOHN DEERE® FORAGE HARVESTERS

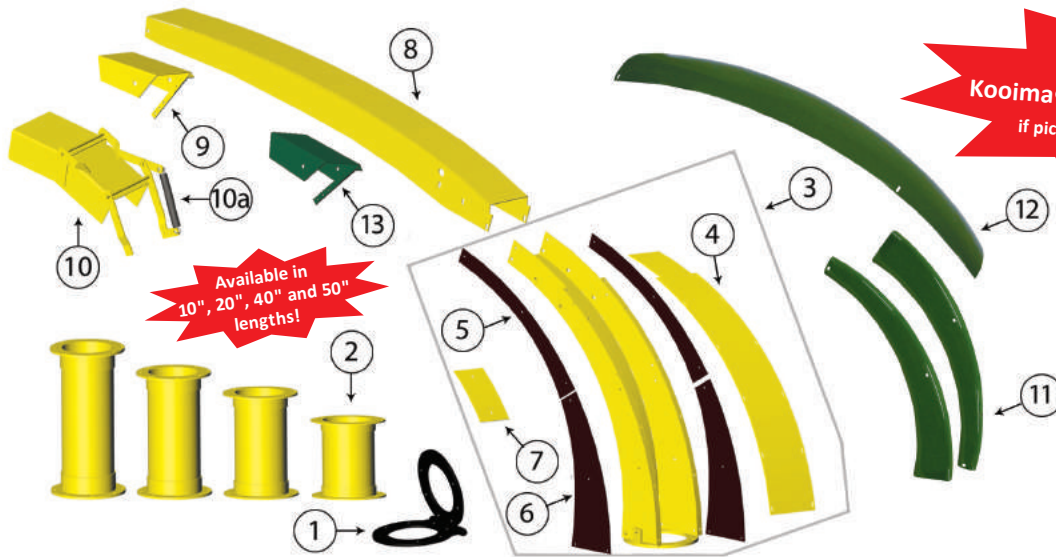
Replacement parts produced by Kooima® Company to fit JD® 5000 Series



KOOIMA #	DESCRIPTION	REPLACES OEM #
K79396 \$13.80 ea.	 • Spout deflector spring • To fit all John Deere® factory and Kooima® spouts • .3 lbs.	E79396
K50000 \$190.75 ea.	① • Spout hinge kit • To fit all 5000 series harvesters • Mounting hardware included • Allows you to fold the spout down for transport or low clearance storage • 27.6 lbs.	
K37336 \$250.75 ea.	② • 10" spout extension • 29.3 lbs. • To fit all 5000 series harvesters • Bolt kit: K37336BK, \$23.80 ea., 1.2 lbs.	AE37336
K37337 \$300.80 ea.	②a • 20" spout extension • 38 lbs. • To fit all 5000 series harvesters • Bolt kit: K37336BK, \$23.80 ea., 1.2 lbs.	AE37337
K37338 \$325.80 ea.	②b • 40" spout extension • 55 lbs. • To fit all 5000 series harvesters • Bolt kit: K37336BK, \$23.80 ea., 1.2 lbs.	AE37338
K37339 \$410.80 ea.	②c • 50" spout extension • To fit all 5000 series harvesters • 65.5 lbs. • This is a must when top loading trucks in rough terrain • Bolt kit: K37336BK, \$23.80 ea., 1.2 lbs. *All Kooima® spout extensions are reinforced, top and bottom, for added strength.	
K37331 \$750.00 ea.	③ • Lower spout assembly • Includes wear plates listed below • To fit all 5000 series harvesters • Does NOT fit with John Deere® upper spout assembly • Easy to replace bolt-in wear plates make repairs a snap! • 112 lbs. 	AE37331
Kooima® spout assemblies feature an exclusive enclosed design for superior performance in all crops, including hard-to-blow dry hay. Replaceable abrasion resistant wear plates make this the most durable spout available.		
K37340 \$120.75 ea.	④ • Rear spout cover • 28 lbs.	Abrasion Resistant
K37341 \$40.35 ea.	⑤ • Top inside wear plates • 2 required • 3.2 lbs.	Abrasion Resistant
K37342 \$40.35 ea.	⑥ • Bottom inside wear plate • 2 required • 6 lbs.	Abrasion Resistant
K37343 \$20.30 ea.	⑦ • Inspection cover door • 2.5 lbs.	Abrasion Resistant
K38645 \$300.80 ea.	⑧ • Upper spout extension • Standard 85" length, used with 4-row heads when side loading or rear loading • 63.5 lbs.	Abrasion Resistant
K38646 \$330.80 ea.	⑧a • Upper spout extension • 115" length for use with 6-row heads and side loading • Great for top loading trucks! • 77 lbs.	Abrasion Resistant
K38645BK \$5.25 ea.	⑧b • Upper spout extension bolt kit • Use with 85" or 115" extension • 1.25 lbs.	
K38647 \$57.85 ea.	⑨ • Spout deflector • To fit all 5000 series using Kooima® spout assembly • 8.5 lbs.	Abrasion Resistant
K38647BK \$3.75 ea.	⑨a • Spout deflector bolt kit • .2 lbs.	
K38647SP \$195.75 ea.	⑩ • Double spout deflector assembly • Allows precise control of feed flow & more complete filling of your truck or wagons • Comes with a spring • To fit all 5000 series using Kooima® & JD® spout assemblies • 20.1 lbs.	Abrasion Resistant
FH001303 \$12.75 ea.	⑩a • Replacement spring for double deflector • .9 lbs.	
K52447 (LH) K52448 (RH) \$63.00 ea.	⑪ • Left hand spout liner • Right hand spout liner • To fit all 5000 series equipped with John Deere® factory spout • 7.4 lbs. • Hardware Kit: K52447BK, \$12.25, .62 lbs.	FH312296 / E52447 FH312290 / E52448 Abrasion Resistant
K76994 \$92.50 ea.	⑫ • Center spout liner • 16.7 lbs. • Hardware Kit: K76994BK, \$4.75 • To fit all 5000 series equipped with John Deere® factory spout	FH312199/E76994 Abrasion Resistant
K22358 \$49.35 ea.	⑬ • Spout deflector • To fit all 5000 series equipped with John Deere® factory spout • 4.1 lbs.	AFH205884 / AE22358 Abrasion Resistant

KOOIMA® REPLACEMENT PARTS TO FIT 5000 SERIES JOHN DEERE® FORAGE HARVESTERS

Replacement parts produced by Kooima® Company to fit JD® 5000 Series

KOOIMA #	DESCRIPTION	REPLACES OEM #
K85879 \$615.00 ea.	<ul style="list-style-type: none"> • 5440 and 5460 final drive pinion shaft • 13 Tooth • Fits 5720 and 5820 below serial number 651000 • 6.2 lbs. 	H85879
K73345 \$1,175.00 ea.	<ul style="list-style-type: none"> • 5730, 5820 and 5830 gear case shaft • \varnothing 2 3/8" OD spline on gear side (2" on older series, 5400) • 12.4 lbs. 	AE44315 AE73345
K71361 \$340.00 ea.	<ul style="list-style-type: none"> • Feed roll gear case shaft • To fit JD® 5200, 5400, 5440, 5460, 5720, 5820, 5730 and 5830 series • 6.5 lbs. 	E71361 / E58632
K35549 \$490.00 ea.	<ul style="list-style-type: none"> • Modified main gear case shaft • To fit all 5000 series • 43.5 lbs. 	AE35549 Heat Treated



Your #1 Source For Used Parts

John Deere® Self-Propelled Forage Harvester PARTS



1-877-427-6950

www.iowacuttersupply.com

Claas® John Deere® Kemper™ New Holland® Krone®

Iowa Cutter Supply
1 1/2 miles East on Hwy 18
2642 Rock Ridge Road
Rock Valley, IA 51247

If you have a cutter to sell:
Email pictures and a description to
sales@iowacuttersupply.com
or
Call 1-877-427-6950 and ask for Ivan



KOOIMA® REPLACEMENT PARTS TO FIT 6000 SERIES JOHN DEERE® FORAGE HARVESTERS

John Deere® and JD® are registered trademarks of Deere & Company, which does not manufacture, distribute or endorse these parts.

Replacement parts produced by Kooima® Company to fit JD® 6000 Series

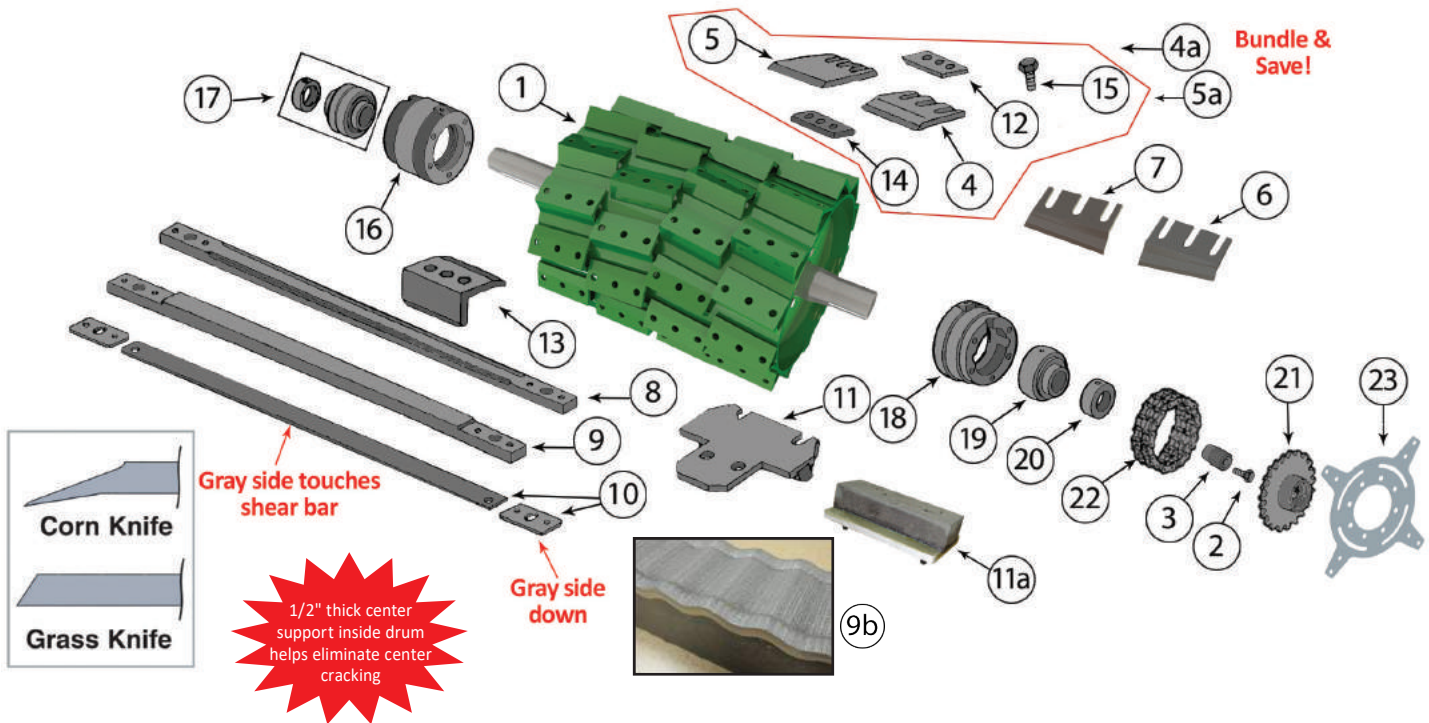

KOOIMA #	DESCRIPTION	REPLACES OEM #
K103888 \$3,910.00 ea.	① • 40 knife drum • 563 lbs. • To fit all 6000 series • Will need to order K71387 Hub & K19M8610 Bolt	AZ103888
K101200 \$4,110.00 ea.	①a • 48 knife drum • Angled knife brackets • 592 lbs. • To fit all 6000 series • Will need to order K71387 Hub & K19M8610 Bolt	AZ101200
K101199 \$4,150.00 ea.	①b • 56 knife drum • Straight knife brackets • 628 lbs. • To fit all 6000 series • Will need to order K71387 Hub & K19M8610 Bolt	AZ101199
K19M8610 \$6.00 ea.	② • Bolt • Used for K71387 splined hub • .5 lbs.	19M8610
K71387 \$37.35 ea.	③ • Splined hub • 2.1 lbs • To fit all 6000 series • Uses the K71139 sprocket	Z71387
K63136 \$18.20 ea.	④ • Corn knife • To fit all 6000 series harvesters • Wider design for fewer unchopped leaves • 48 required • 1.4 lbs.	Z63136/Z56647 Heat Treated/Tungsten Carbide
K63136KIT \$39.10 ea.	④a • Kit Includes (1) K63136, (1) K49623, (1) K71196, (3) K69650 • Save \$ when buying the kit! • 4 lbs./kit	
K63136HP \$23.50 ea.	④b • Hi-performance corn knife • Lasts longer than factory OEM knives • 1.5 lbs. • Thicker Tungsten carbide edge	Z63136 Heat Treated/Tungsten Carbide
K69500 \$16.70 ea.	⑤ • New longer grass knife • To fit all 6000 series harvesters • 1.6 lbs. • Reduces knife breakage by providing more knife to angle bearing surface	Z69500 Heat Treated/Tungsten Carbide
K69500KIT \$37.70 ea.	⑤a • Kit includes (1) K69500, (1) K49623, (1) K71196, (3) K69650 • Save \$ when buying the kit! • 4.2 lbs./kit	
K69500HP \$20.05 ea.	⑤b • Hi-performance grass knife • 1.6 lbs. • Thicker tungsten carbide edge	Z69500 Heat Treated/Tungsten Carbide
K62075 \$22.90 ea.	⑥ • Angled corn knife • Right hand • To fit all 6000 series • 1.5 lbs.	Z62075 Heat Treated/Tungsten Carbide
K62075HP \$26.55 ea.	⑥a • High performance angled corn knife • Right hand • 1.5 lbs. • To fit all 6000 series • Thicker tungsten carbide edge	Z62075 Heat Treated/Tungsten Carbide
K62076 \$22.90 ea.	⑦ • Angled corn knife • Left hand • To fit all 6000 series • 1.5 lbs.	Z62076 Heat Treated/Tungsten Carbide
K62076HP \$26.55 ea.	⑦a • High performance angled corn knife • Left hand • 1.5 lbs. • To fit all 6000 series • Thicker tungsten carbide edge	Z62076 Heat Treated/Tungsten Carbide
K47614 \$450.00 ea.	⑧ • Corn shearbar • 21.1 lbs. • To fit 6000 series with SN. 504341 and below	AZ47614 Heat Treated/Tungsten Carbide
K47614HP \$600.00 ea.	⑧a • High performance shearbar • 21.5 lbs. • For use in hay or corn • To fit 6000 series with SN. 504341 and below	AZ47614 Heat Treated/Tungsten Carbide
K47614BK \$19.80 ea.	⑧b • Shearbar bolt kit • .5 lbs. • To fit all 6000 series shearbars with SN. 50431 & below	

Truck icon signifies product is shipped via truck freight.

KOOIMA® REPLACEMENT PARTS TO FIT 6000 SERIES JOHN DEERE® FORAGE HARVESTERS

Replacement parts produced by Kooima® Company to fit JD® 6000 Series

KOOIMA #	DESCRIPTION	REPLACES OEM #
K53906 \$560.00 ea.	9 • Corn shearbar, 36mm thick • To fit all 6650, 6750, 6850 & 6950 harvester SN. 504342 & after • 29.4 lbs.	AZ53906 Heat Treated/Tungsten Carbide
K53906HP \$660.00 ea.	9a • High performance shearbar • To fit 6000 series SN. 504992 & after • 30.7 lbs.	AZ53906 Heat Treated/Tungsten Carbide
K53906DSW \$1,175.00 ea.	9b • Koyma Klad® hi-performance double sine wave shearbar • Patent # 8,109,176 • To fit 6000 series harvesters • Maximize your shear bar's cutting surface! • Koyma Klad® coating maintains a long lasting sharp edge for more tons per hour • 30.4 lbs.	
K53905 \$450.00 ea.	9c • Grass shearbar, 36mm thick • To fit late 6650, 6750, 6850 & 6950 harvesters SN. 504342 & after • 29.5 lbs.	AZ53905/AZ103112 Heat Treated/Tungsten Carbide
K64735HPBK \$19.80 ea.	9d • Shearbar bolt kit • 1.65 lbs. • To fit K53906, K53906HP, K53905 & K64735HP	
K49450 \$60.45 ea.	10 • Shearbar wear strip kit • To fit all 6000 series harvesters • Includes (1) #K49449 long wear strip & (2) #K72350 short wear strips • Gray side of wear strip always touching shear bar • 1 kit required • 1.3 lbs.	E72350/Z49449
K48700 \$75.45 ea.	11 • Sharpening stone • To fit all 6000 series SN. 504991 and below • 4 lbs. • Bolt kit: K48700BK, \$1.75 ea. .10 lbs.	AZ53747/AZ48700
K56626 \$70.45 ea.	11a • Sharpening stone • To fit 6000 series SN. 504992 and after • 3 lbs. • Bolt kit: K56626BK, \$2.75 ea. .10 lbs.	AZ56626
K49623 \$8.75 ea.	12 • Top strap • To fit all 6000 series harvesters • 48 required • 1 lb.	Z49623/Z60535 Heat Treated
K70982 \$11.50 ea.	13 • Angle bracket • Weld-on • 3.1 lbs. • To fit all 6000 series harvesters • Old style straight knife bracket	Z101528 Z70982
K71196 \$7.75 ea.	14 • Bottom nut • .9 lbs. • Used with angled knife brackets • To fit all 6000 series harvesters • 48 required	Z71196/Z49625
K69650 \$2.15 ea.	15 • Knife bolt • Grade 10.9 metric • .2 lbs. • 144 required • To fit all 6000 series harvesters	Z69650/Z61067
K12816 \$550.80 ea.	16 • RH bearing housing • 28 lbs. • To fit all 6000 series harvesters up to SN 510523 • Bolt kit: K12816BK, \$17.80 ea., 3.5 lbs.	Z12816
K48939 \$415.80 ea.	17 • RH spherical bearing • 6.3 lbs. • To fit all 6000 series harvesters up to SN 510523 • Will need to get K39504 seal, \$19.30 ea. Replaces OEM # AZ39504	AZ48939
K12815 \$430.80 ea.	18 • LH bearing housing • 15.5 lbs. • To fit all 6000 series harvesters up to SN 510523 • Bolt kit: K12815BK, \$13.30 ea., 2.5 lbs.	Z12815
K9307 \$157.75 ea.	19 • LH bearing • Fits shaft with 2.94" OD • To fit all 6000 series harvesters up to SN 510523 • 6.3 lbs.	JD9307
K9308 \$20.80 ea.	20 • LH locking collar • To fit all 6000 series harvesters up to SN 510523 • 1.3 lbs.	JD9308
K71139 \$163.25 ea.	21 • 28 tooth sprocket • 6.15 lbs. • Fits all 6000 series machines with Electromagnetic clutch (STROMAG)	AZ71139
K63229 \$42.85 ea.	22 • 28 link chain • 3.83 lbs. • Also need K60LINK • Fits all 6000 series machines with Electromagnetic clutch (STROMAG)	AZ63229
K60LINK \$4.25 ea.	22a • 60 chain link • .1 lbs. • Fits all 6000 series machines with Electromagnetic clutch (STROMAG)	
K101305 \$105.75 ea.	23 • Electromagnetic clutch plate (STROMAG) • 1.25 lbs. • To fit harvesters 6610-7550 • 2 required • Made from high wear spring steel • Bolt kit: K101305BK, \$4.05 ea. .25 lbs.	AZ101305 Heat Treated
FH5001045 \$1,100.00 ea.	24 • Replacement cutter drum shaft • To fit Kooima® drums only • 134 lbs.	

K63686

\$300.80 ea.



- LOC gear box shaft Z63686
- To fit JD® 6610-6910 harvesters serial #002776 and above
- To fit JD® 7200-7550 harvesters

K6000WSC

\$200.75 ea.



- Windshield cover
- To fit all 6000 series harvesters
- Eliminates cracked and broken windshields
- Double sewn heavy duty, padded vinyl construction
- Stainless steel dee rings
- 14 lbs.

Order online at WWW.KOOIMA.COM and receive FREE FREIGHT to your door!

KOOIMA
COMPANY



KOOIMA® REPLACEMENT PARTS TO FIT 6000 SERIES JOHN DEERE® FORAGE HARVESTERS

Replacement parts produced by Kooima® Company to fit JD® 6000 Series

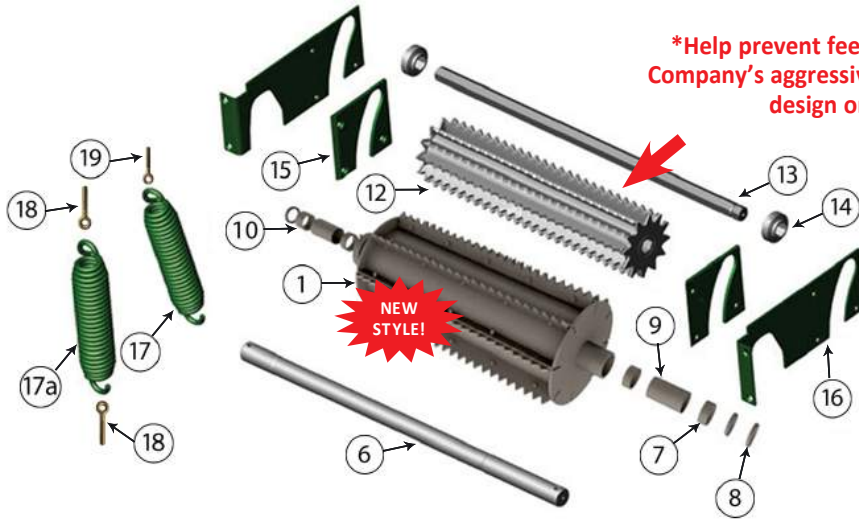

***Help prevent feeding problems with Kooima® Company's aggressive upper rear feed roll. The best design on the market today!**

KOOIMA #	DESCRIPTION	REPLACES OEM #
K50611SP \$1,510.00 ea.	1 • Special upper front feed roll, great for corn & cane! • To fit all 6000 series • Heavy Duty 4 Large Bearing Design! • Complete with bolt-on teeth and bearings • 91 lbs. w/o teeth	AZ101035/AZ50611 AZ58228/AZ102095/AZ101103 Stainless Steel Stainless Steel
K50611SPT \$57.35 ea.	2 • Bolt-on tooth • To fit #K50611SP roll • To fit all 6000 series harvesters equipped with Kooima® upper front feed rolls • 8 required • 22 lbs./8 pc. set	Stainless Steel
K50611SPFT \$49.35 ea.	3 • Flat replaceable crossbar • To fit #K50611SP feed roll • Eliminates wrapping in haylage • 3 lbs. ea.	Stainless Steel
K50611SPTBK \$57.35 ea.	4 • Hardware kit for K50611, K50611SPT, & K50611SPFT • 2.5 lbs.	
K73857 \$52.35 ea.	5 • Bolt-on tooth • 8 required • 2.25 lbs. • To fit all 6000 series equipped with factory upper front feed roll	HXE64649/E73857 Stainless Steel
K73857BK \$57.35 ea.	5a • Hardware kit for K73857 • 3 lbs.	
K81671 \$340.80 ea.	6 • Upper front feed roll shaft • To fit John Deere® harvesters with the new larger 4-bearing system • 26.5 lbs.	Z81671 Heat Treated
K10071 \$16.80 ea.	7 • Upper front feed roll bearing - larger diameter style • 3 required • .2 lbs.	JD10071
K28870 \$12.75 ea.	8 • Upper front feed roll seal • 3 required • .1 lbs.	AL28870
K101917 \$21.80 ea.	9 • Upper front feed roll bushing • Used with larger diameter bearing system • .6 lbs.	Z101917
K62417 \$19.30 ea.	10 • Upper front feed roll bearing - larger diameter style • Used with larger diameter bearing system • 1 required • .35 lbs.	AZ62417
K10108 \$9.25 ea.	11 • Needle bearing • Original smaller bearing style • .2 lbs. • Use with K50611SP feed rolls with 2" diameter bearing system	JD10108
K48677 \$650.00 ea.	12 • Upper rear feed roll • To fit all 6000 series harvesters • Reversible aggressive design • 68 lbs.	AZ48677/AZ51787 Stainless Steel
K71834 \$630.80 ea.	12a • Upper rear feed roll • Reversible aggressive design • This feed roll is made with AR material • 68 lbs.	AZ71834 Abrasion Resistant
K63862 \$140.75 ea.	13 • Upper rear feed roll shaft • To fit all 6000 series • 38-3/16" x 32mm hex shaft • 16 lbs.	Z63862 / Z81670 Heat Treated
K10458 \$40.35 ea.	14 • Upper rear feed roll bearing • 2 required • To fit all 6000 series harvesters • 1 lb.	JD10458
K61010 (Left) K61011 (Right) \$26.55 ea.	15 • Wear plate, feed roll frame • To fit all 6000 series harvesters • 1 each required • 2.8 lbs. ea.	Z61010 Z61011 Heat Treated
K61010BK \$9.25 ea.	15a • Hardware kit to fit K61009(LH) & K61008(RH) • Also bolts up K61010(LH) & K61011(RH) • 1 bolt kit required per wear plate • .2 lbs.	
K61009 (Left) K61008 (Right) \$20.30 ea.	16 • Feed roll wear plate retainer • To fit all 6000 series harvesters • 1 each required • 4.8 lbs. ea.	Z61009 Z61008 Abrasion Resistant
K64796 \$63.45 ea.	17 • Rear feed roll lift arm spring • Use as required • To fit all 6000 series harvesters • 12 lbs.	Z67236 / E64796
K75927 \$47.85 ea.	17a • Front spring for the double spring assembly • To fit all 6000 series harvesters • 6.4 lbs.	Z75927
K76429 \$24.30 ea.	18 • Front spring eye bolt • Includes 2 nuts • To fit 6000-7000 series harvesters • .6 lbs.	Z76429 14M7276
K103433 \$35.85	19 • Rear spring eye bolt • Includes 2 nuts • To fit 6000-7000 harvesters • 1.37 lbs.	Z103433/Z62088 14M7306

KOOIMA® REPLACEMENT PARTS TO FIT 6000 SERIES JOHN DEERE® FORAGE HARVESTERS

Replacement parts produced by Kooima® Company to fit JD® 6000 Series

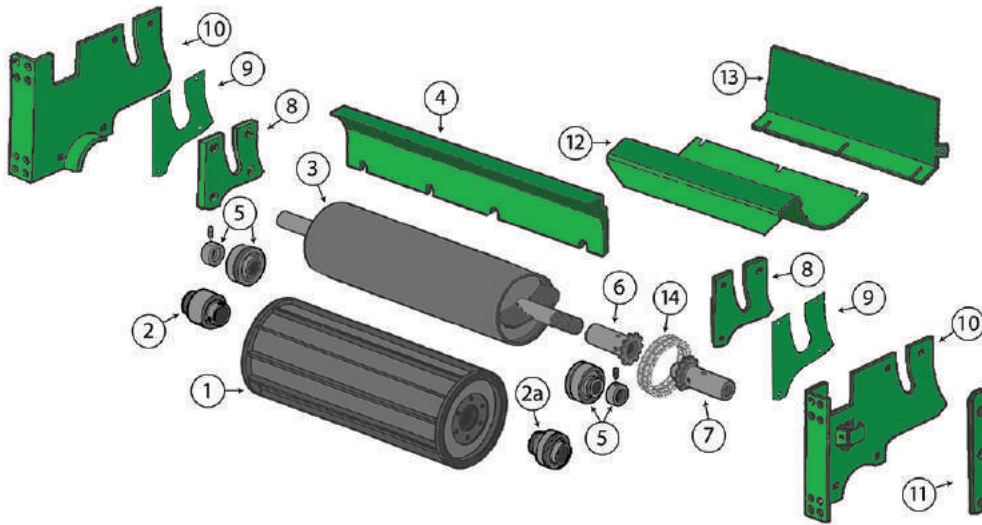

KOOIMA #	DESCRIPTION	REPLACES OEM #
K50090 \$1,080.00 ea.	① • Feed roll, lower front • To fit all 6000 series harvesters • 56.4 lbs.	AZ50090/AZ101149 Stainless Steel
K51405 \$53.35 ea.	② • Right hand bearing • Lower front feed roll • To fit all 6000 series harvesters • 1 required • 1.4 lbs.	AZ51405
K47864 \$47.35 ea.	②a • Left hand bearing • Lower front feed roll • To fit all 6000 series harvesters • 1 required • 1.5 lbs.	AZ47864/AXE10405
K58444 \$515.80 ea.	③ • Lower rear smooth roll • To fit all 6000 series harvesters • 52 lbs. • Now made of heat treated carbon steel for better wear resistance	AZ103271/AZ58444 Heat Treated
K13019 \$195.75 ea.	④ • Smooth roll cleaner, 4 7/8" tall • 14.6 lbs. • To fit 6000 series harvesters SN. 504341 & before	Z13019
K12818 \$195.75 ea.	④a • Smooth roll cleaner, 5 3/8" tall • To fit 6000 series harvesters SN. 504342 & after series harvesters • 18.7 lbs.	Z13356 Z12818
K12818BK \$4.50 ea.	④b • Bolt kit • To fit K13019 and K12818	
K10445 \$52.35 ea.	⑤ • Smooth roll bearing • 1.2 lbs. • To fit all 6000 series harvesters • 2 required	JD10445
K51114 \$89.95 ea.	⑥ • Inside smooth roll drive coupler • To fit all 6000 series harvesters • 2.5 lbs.	AZ51114
K51115 \$91.95 ea.	⑦ • Outside smooth roll drive coupler • To fit all 6000 series harvesters • 3.4 lbs.	AZ51115
K61012 (Left) K61013 (Right) \$60.45 ea.	⑧ • Feed roll wear plate • To fit 6000 series harvesters SN. 504341 & before • 4 lbs. ea.	Z61012/Z65168 Z61013/Z65167 Heat Treated / Tungsten Carbide
K68062 (Left) K68063 (Right) \$69.45 ea.	⑧a • Feed roll wear plate • To fit 6000 series harvesters SN. 504342 & after series harvesters • 1 each required • 4 lbs. ea.	Z68062 Z68063 Tungsten Carbide
K68083 \$18.80 ea.	⑨ • Reinforcement • To fit all 6000 series harvesters • 1 lb.	Z68083
K100685 (Left) K100686 (Right) \$75.45 ea.	⑩ • Feed roll wear plate • To fit all 6000 series harvesters • 1 each required • 8.9 lbs.	AZ100685 AZ100686 Abrasion Resistant
K101960BK \$17.05 ea.	⑩a • Feed roll wear plate bolt kit • 1 kit required per side • .7 lbs.	
K33163 \$31.60 ea.	⑪ • Feed roll tensioning arm wear strip • .6 lbs. • To fit all 6000 series harvesters • Made of high grade Teflon material	CC33163
K63659 \$70.45 ea.	⑫ • Lower feed roll pan • Front pan, used when grinding ear corn with recutter screen • To fit all 6000 series harvesters • 28.2 lbs.	Z63659 Abrasion Resistant
K50086 \$80.45 ea.	⑬ • Lower feed roll pan • Rear pan, used when grinding ear corn with recutter screen • To fit all 6000 series harvesters • 12.3 lbs.	AZ50086 Abrasion Resistant
K50086BK \$6.25 ea.	⑬a • Earlage pans bolt kit • To fit all series earlage pans • 1 kit required • .25 lbs.	
K47886 \$55.35 ea.	⑭ • 14 link chain • To fit all 6000 series harvesters • 1 lb.	AZ47886
K47886BK \$3.25 ea.	⑮ • Bolt kit for K47886 • .1 lbs. • To fit all 6000 series harvesters	

TO ORDER CALL TOLL FREE 1-800-522-8874

KOOIMA® REPLACEMENT PARTS TO FIT 6000 SERIES JOHN DEERE® FORAGE HARVESTERS

Replacement parts produced by Kooima® Company to fit JD® 6000 Series

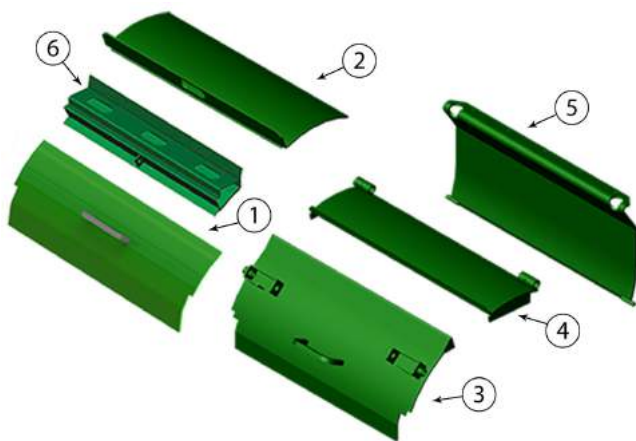

KOOIMA #	DESCRIPTION	REPLACES OEM #
K45119 \$100.75 ea. (1)	• Cutterhead door • To fit 6000 series harvesters SN. 504991 & before • 19 lbs.	AZ45119/AZ104219 Abrasion Resistant
K39714 \$63.95 ea. (2)	• Cutterhead door • To fit 6000 series harvesters SN. 504991 & before • 24 lbs.	AZ39714 Abrasion Resistant
K54310 \$74.00 ea. (3)	• Cutterhead door • To fit late 6650, 6750, 6850 & 6950 harvester SN. 504992 & after • 28.3 lbs.	AZ54310 Abrasion Resistant
K54323 \$63.00 ea. (4)	• Cutterhead door • To fit late 6650, 6750, 6850 & 6950 harvester SN. 504992 & after • 18.8 lbs.	AZ54323 Abrasion Resistant
K52676 \$77.95 ea. (5)	• Cutterhead shield • To fit all 6000 series harvesters • 39.6 lbs.	AZ52676 Abrasion Resistant
K47099 \$79.95 ea. (6)	• Cutterhead cover • 19 lbs. • To fit 6000 series harvesters SN. 504991 & before	AZ47099

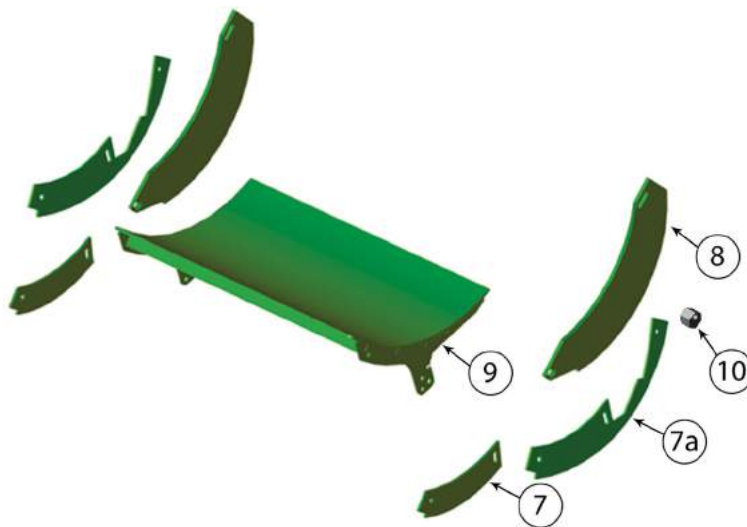

KOOIMA #	DESCRIPTION	REPLACES OEM #
K48655 \$7.75 ea. (7)	• Cutterhead housing wear plate • To fit all 6000 series harvesters • 2 required • 1.95 lbs. • Hardware kit: K48655BK , \$3.25 ea. • .15 lbs.	Z48655/Z72502 Abrasion Resistant
K48655LHS (Left) K48655RHS (Right) (7a) \$20.05 ea.	• Extended cutterhead wear plates • Protects more of your expensive cutterhead housing • 1 each required • 3 lbs. ea.	Z48655/Z72502 Abrasion Resistant
K59850 (Left) K59851 (Right) (8) \$25.00 ea.	• Cutterhead bracket • 9.8 lbs. ea. • To fit all 6000 series harvesters • 1 each required • Hardware Kit: K59850BK , \$10.25 ea., .62 lbs.	Z75383 Abrasion Resistant
K51112 (9) \$179.00 ea.	• Spiral floor plate • New shorter style is 30mm shorter to allow closer adjustment to cutterhead knives. • Improves material delivery to blower • To fit all 6000 series harvesters • 51.7 lbs.	AZ54153/AZ51112 Abrasion Resistant
K64299C (10) \$12.25 ea.	• Cutterhead bracket adjusting cam • To fit all 6000 series harvesters • 2 required • .45 lbs.	E64299

KOOIMA® REPLACEMENT PARTS TO FIT 6000 SERIES JOHN DEERE® FORAGE HARVESTERS

Replacement parts produced by Kooima® Company to fit JD® 6000 Series

KOOIMA #
K51112HP



\$900.80 ea.

DESCRIPTION

- Cracker plate
- To fit 6000 series harvesters • 54.2 lbs.
- Cracks 85-90% of kernels with minimal power requirements
- Bolt-in installation
- No moving parts to maintain
- Use in whole plant corn silage or to grind earlage
- Patent #6,234,072 & #6,327,970

REPLACES OEM #

Abrasion Resistant
Tungsten Carbide

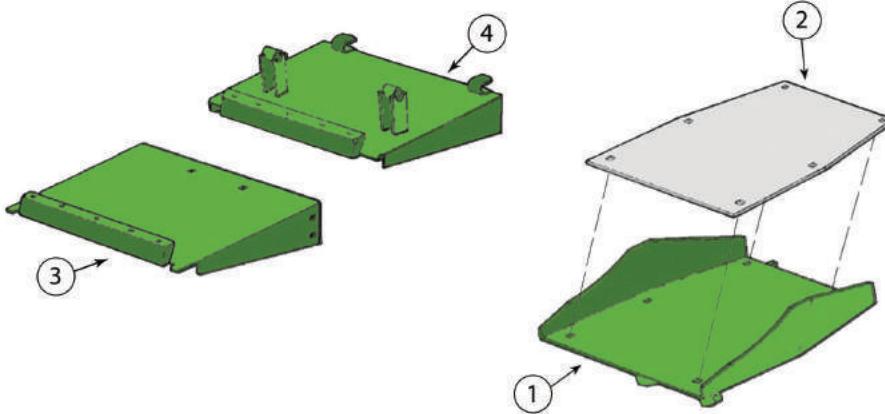

KOOIMA #
K52395

\$89.45 ea.

①

DESCRIPTION

- 1-piece grass chute • To fit all 6000 series • 33 lbs.
- Use with liner #K66289 • Replaces original 2-piece chute
- Reduces plugging between cutterhead & blower

REPLACES OEM #

AZ52395/ AZ48619
AZ45110

Abrasion Resistant

K63188

\$89.45 ea.

①a

- New style 1-piece grass chute • To fit all 6000 series • 33 lbs.
- Improves crop flow in sticky or gummy conditions • Use with liner #K66289 and new style feed guide #K63189 • Some machine modification required • Installation instructions included

Abrasion Resistant

K66289

\$120.75 ea.

②

- Stainless steel liner • 19 lbs.
- To fit all 6000 series with 1-piece grass chute

Z66289

Stainless Steel

K78611BK

\$3.25 ea.

②a

- Stainless steel liner bolt kit • .5 lbs.
- Use with stainless steel liner K66289 • One kit required

K61182

\$69.45 ea.

③

- Grass chute, top • 22 lbs.
- To fit all **6000** series **without kernel processors**

Z61025/ Z61182

Abrasion Resistant

K61182BK

\$26.70 ea.

③a

- Grass chute bolt kit • .5 lbs.
- Use with grass chute K61182

K50457

\$89.45 ea.

④

- Quick change grass chute, top • 24 lbs.
- To fit all **6000** series equipped **with kernel processors**

AZ50457

Abrasion Resistant

The Rock Stop'er Pro

FORAGE HARVESTER STONE DETECTION SYSTEM



JD® must have double spring kit installed.

- Fits most makes and models of SPFH and pull type harvesters.
- Patented Inertia sensor stops feed drive when rocks are detected.
- In cab sensitivity adjustment for varying crop conditions.
- Call 1-800-522-8874 for more details!



Extra Sensor Available!
Order # SENSOR
Only \$750⁸⁰ ea.

Order # ROCK STOPER
Only \$2,950⁰⁰ ea.



Designed and manufactured in Canada.

Order online at WWW.KOOIMA.COM and receive FREE FREIGHT to your door!

KOOIMA
COMPANY

KOOIMA® REPLACEMENT PARTS TO FIT 6000 SERIES JOHN DEERE® FORAGE HARVESTERS

Replacement parts produced by Kooima® Company to fit JD® 6000 Series

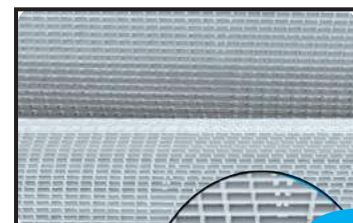
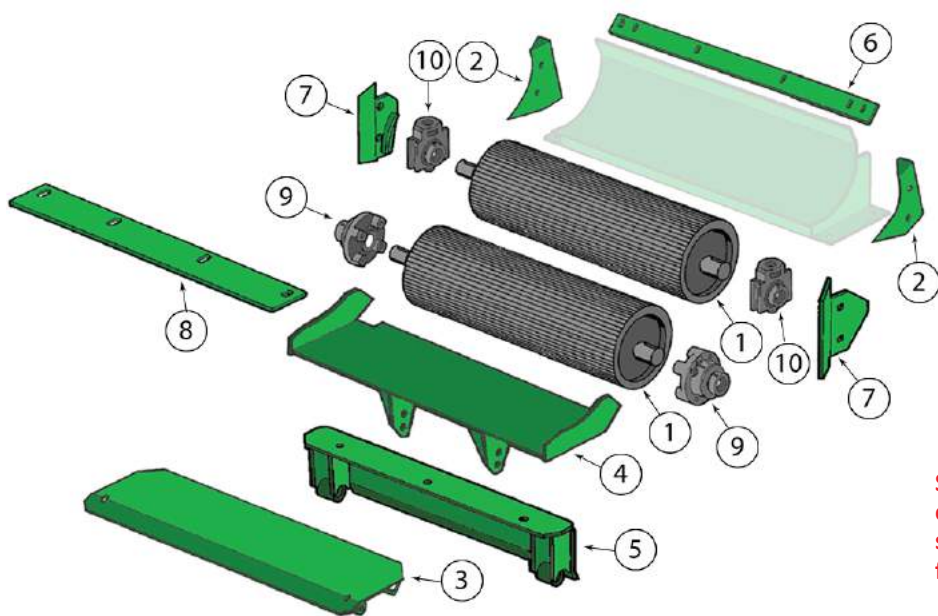

NEW!

See our new **Chevron Series Fiber Tech High Capacity Rolls** listed below!

Square grooves unwrap cellulose and shred your stalk which also creates a far superior process job.

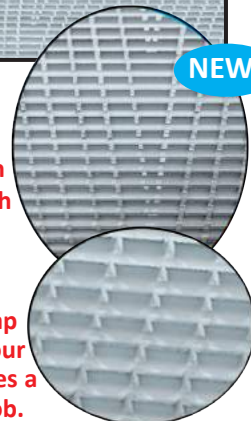

Now compatible with JD® Labyrinth seal system!

KOOIMA #
K53319

1

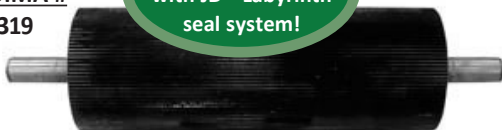

DESCRIPTION

- Kernel processor roll • 152.5 lbs.
- **New saw tooth design delivers a more aggressive cracking action in longer length crops**
- To fit all 6000 series harvesters • 2 required

REPLACES OEM #
AZ53319/AZ101800
Heat Treated
106 tooth

\$1,190.00 ea.

K53319DC

1a



- Kernel processor roll • 152.5 lbs.
- Get the real value out of your processor with the new **Dual Cut High Capacity Rolls**
- To fit all 6000 series harvesters • 2 required

AZ53319/AZ101800
Heat Treated

\$1,295.00 ea.

K53319HPF (Fast, Bottom 106 tooth)

K53319HPS (Slow, Top 120 tooth)

1b



- Kernel processor roll • 153 lbs.
- Get the real value out of your processor with the new **Chevron Series Fiber Tech High Capacity Rolls**
- To fit all 6000 series harvesters • 2 required

AZ53319
Heat Treated
Chromed Plated Roll

\$1,675.00 ea.

K12739 (Right)

K12738 (Left)

2

\$50.35 ea.

- Cast kernel processor deflector • 2.2 lbs.
- To fit all **6000** series equipped with kernel processor
- **Hardware kit: K12739BK**, \$3.75 ea., .15 lbs.

Z12739
Z12738

K48919

3

\$83.45 ea.

- Kernel processor deflector • 17.6 lbs.
- To fit all 6000 series processors

AZ48919

Abrasion Resistant

K50434

4

\$91.95 ea.

- Bottom cover • To fit all **6000** series equipped with quick conversion processor frame • 29.6 lbs. • **Hardware kit: K50434BK**, \$30.35 ea. • .55 lbs.

AZ50434

Abrasion Resistant

K50435

5

\$165.75 ea.

- Bottom shield • To fit all **6000** series equipped with quick conversion processor frame • 13.5 lbs.

AZ50435

K62347

6

\$31.35 ea.

- Deflector • 5.8 lbs.
- To fit all 6000 series harvesters

Z62347

Abrasion Resistant

K50472 (Left)

K50473 (Right)

7

\$29.30 ea.

- Kernel processor wear plate
- To fit all 6000 series harvesters
- 2.4 lbs. ea. • **Hardware kit: K100687BK**, \$4.50 ea., .15 lbs.

AZ50472

AZ50473

Abrasion Resistant

K49938

8

\$25.05 ea.

- Kernel processor top deflector • 6.2 lbs.
- To fit all 6000 series harvesters • **Hardware kit: K49938BK**, \$5.25 ea., .33 lbs.

Z49938

Abrasion Resistant

K56298

9

\$125.75 ea.

- Bearing with housing • 2 required
- To fit **lower** kernel processor rolls • 6.1 lbs.

AZ56298

K56297

10

\$185.00 ea.

- Bearing with housing • 2 required
- To fit **upper** kernel processor rolls • 5.6 lbs.

AZ56297

Koyma Klad® Silage Plus Processor

This processor offers a new and more efficient way to process your silage, saving fuel and gaining capacity. Here at Kooima®, we've been making knives and shearbars for over 20 years. That same extended life coated technology is applied to the teeth in this disc processor. We haven't seen any measurable wear on processors with over 190,000 tons of silage run through the disc. Conventional processing just isn't good enough anymore! To fit all 6000 series harvesters.

\$13,500.⁰⁰

Order # SC3001

Patent: 9833785, Others Pending



999 lbs.

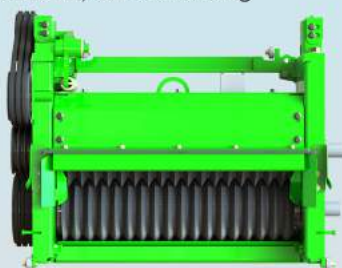

Disc wear after 190,000 tons of silage

Customer Testimonial

"We have used this processor for 2 seasons on our 100 cow dairy plus through our custom work for a 300 cow dairy. Here in Manitoba, our ration consists of 45% alfalfa haylage and balance of corn silage. We have seen a gain in digest-ability in our herd and have been able to increase the length of the cut while still maintaining very good kernel processing. This has increased rumen activity that has resulted in significant increase in production."

- Raymond Pelletier, Millennium Holsteins

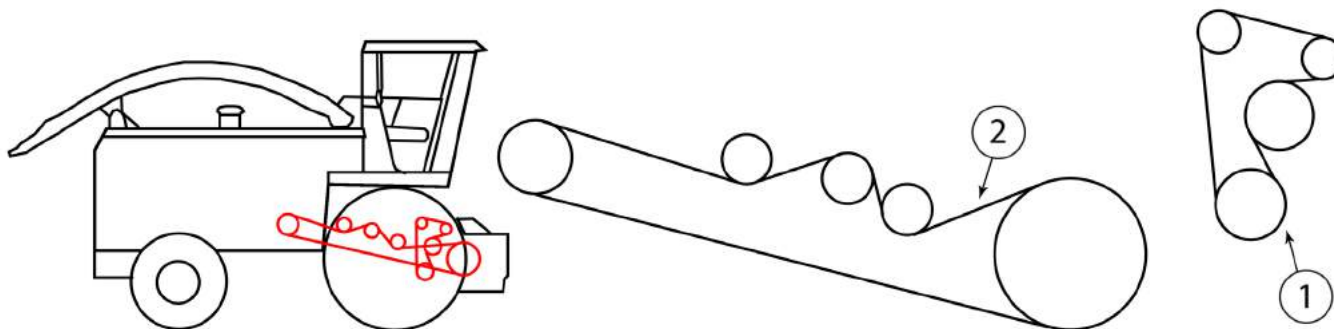

High Quality Gates® Belts

KOOIMA #	DESCRIPTION	REPLACES OEM #
K39677	• Processor belt (set of 3)	AZ39677
\$157.50 per set	• To fit 6000-7550 right side • 77 1/4" long • 3.6 lbs. per set	
K39676	• Kernel processor drive (set of 2)	AZ39676
\$32.75 per set	• To fit 6000-6950 left side • 81" long • 1.9 lbs. per pair	
K53559	• Drum belt (6-groove set)	AZ53559
\$945.00 per set	• To fit 6650-7550 1000 RPM • 247" long • 36 lbs.	
K51638	• Drum belt (7-groove set)	AZ51638
\$1,070.00 per set	• To fit 6950-7850 1150 RPM • 251" long • 37 lbs.	
K51312	• Drum belt (6-groove set)	AZ51312
\$870.00 per set	• To fit 6610-6910 1000 RPM • 232.25" long • 33 lbs.	

KOOIMA® REPLACEMENT PARTS TO FIT 6000 SERIES JOHN DEERE® FORAGE HARVESTERS

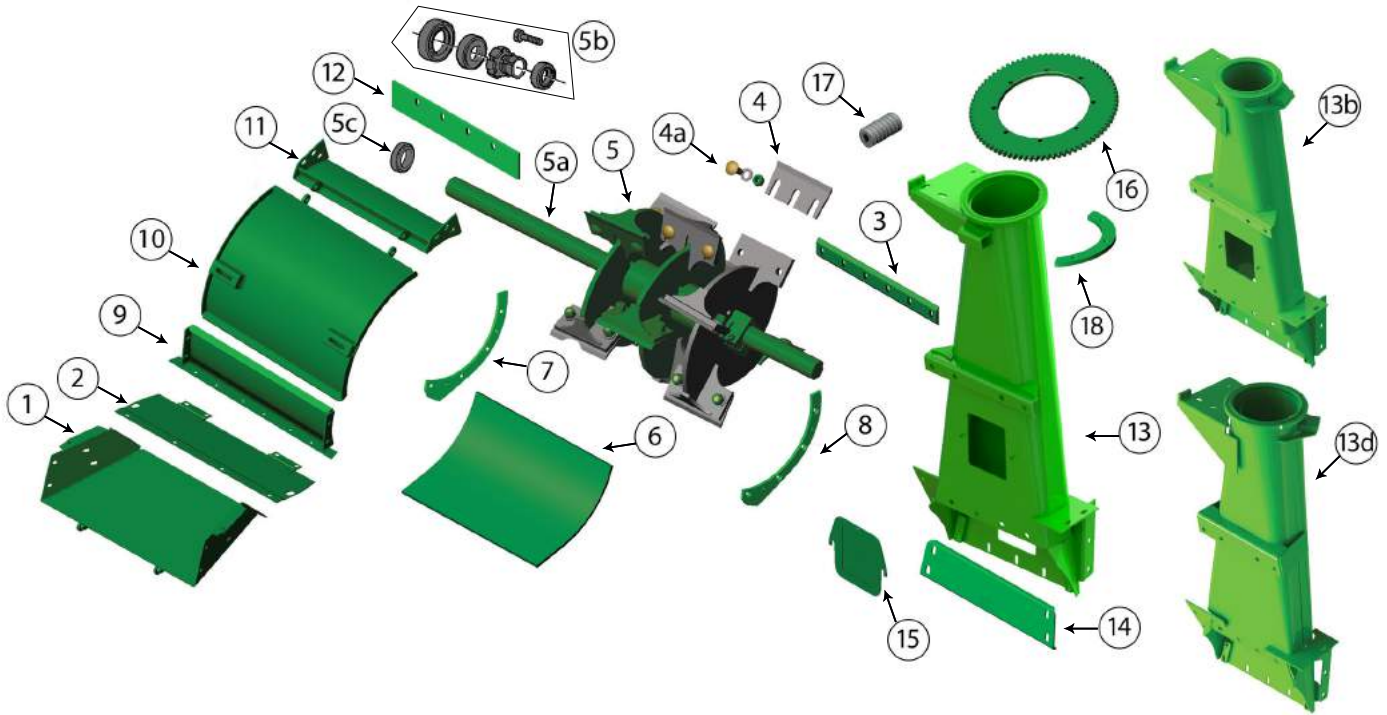

Replacement parts produced by Kooima® Company to fit JD® 6000 Series



KOOIMA #	DESCRIPTION	REPLACES OEM #
K47885 \$58.85 ea.	① • Guide, rear feed channel • Hardware kit: K47885BK , \$5.25 ea., .3 lbs. • To fit all 6000 series harvesters • 16.2 lbs.	AZ47885 Abrasion Resistant
K63189 \$79.45 ea.	①a • New style feed guide • To fit all 6000 series • Improves crop flow in sticky or gummy conditions • Use with new style 1-piece grass chute #K63188 • Some machine modification required • Installation instructions included • 15.5 lbs. • Hardware kit: K47885BK , \$5.25 ea., .3 lbs.	AZ63189 Abrasion Resistant
K47085 \$33.85 ea.	② • Feed guide top flap • Hardware kit: K47085BK , \$5.75 ea. • .25 lbs • To fit all 6000 series harvesters • 4.95 lbs.	AZ47085 Abrasion Resistant
K56737 \$75.45 ea.	③ • Blower paddle • To fit all 6000 series harvesters with early style 4-paddle blower • Pre-beveled & tungsten carbide coated • 3.9 lbs. • Hardware Kit: K56737BK , \$10.25 ea., 1.05 lbs.	Z56737 Heat Treated Tungsten Carbide
K72898 \$13.25 ea.	④ • Blower paddle • To fit all 6000 series harvesters with quick change blower or blower update • 12 required • 1.2 lbs. ea.	Z72898/Z81874 Abrasion Resistant Heat Treated/Tungsten Carbide
K72898BK \$60.00 ea.	④a • Blower Paddle Bolt Kit • Use with K72898 blower paddles • One kit required • 7.4 lbs.	
K51888 \$970.00 ea.	⑤ • Fan rotor assembly • To fit all 6000 series harvesters with 12 paddle blower • Includes fan rotor and shaft, 12 paddles and mounting hardware • 186.5 lbs.	AZ51888 AZ51887
K65324 \$300.80 ea.	⑤a • Blower shaft • To fit all 6000 series harvesters with 12 paddle blower • 37.5 lbs.	Z65324
K10060 \$125.75 ea.	⑤b • Repair kit - includes 2 seals, 1 bearing cone, 1 ring and 1 cap screw • 2 kits needed per blower • 1.8 lbs.	KXE10060
K10451 \$135.75 ea.	⑤c • Bearings • 2 bearings needed per blower • 3.6 lbs.	AXE10451
K58148 \$67.95 ea.	⑥ • Bottom blower band • To fit all early 6000 series harvesters without quick change blower update • 26.7 lbs.	Z58148 Abrasion Resistant

KOOIMA® REPLACEMENT PARTS TO FIT 6000 SERIES JOHN DEERE® FORAGE HARVESTERS

Replacement parts produced by Kooima® Company to fit JD® 6000 Series

KOOIMA #	DESCRIPTION	REPLACES OEM #
K64776 \$84.45 ea.	6a • Bottom blower band • To fit all 6000 series harvesters with quick change blower or blower update • 25.9 lbs.	Z64776 Abrasion Resistant
K62372 \$21.80 ea.	7 • Right hand blower band support strap • Hardware kit: K62372BK , \$9.25 ea. • .35 lbs. • To fit all 6000 series harvesters • 1 required • 2.3 lbs.	Z62372 Abrasion Resistant
K62966 \$21.80 ea.	8 • Left hand blower band support strap • To fit all 6000 series harvesters • 1 required • 2.3 lbs. • Hardware kit: K62372BK , \$9.25 ea. • .35 lbs.	Z62966 Abrasion Resistant
K50114 \$59.35 ea.	9 • Front blower housing shield • Hardware kit: K50114BK , \$9.75 ea. • .45 lbs. • To fit all 6000 series harvesters • 7.9 lbs.	AZ50114 Abrasion Resistant
K46608 \$59.85 ea.	10 • Blower housing door • To fit all 6000 series harvesters • 19.3 lbs.	AZ46608 Abrasion Resistant
K43828 \$49.85 ea.	11 • Top blower housing shield • 6.7 lbs. • To fit all 6000 series harvesters • Hardware Kit: K43828BK , \$9.75 ea., .9 lbs.	AZ43828 Abrasion Resistant
K55782 \$15.05 ea.	12 • Blower housing cutoff strap • Hardware kit: K55782BK , \$8.25 ea. • .55 lbs. • To fit all 6000 series harvesters • 6 lbs.	Z55782 Abrasion Resistant
K42610 \$610.80 ea.	13 • Spout transition • To fit all 6610, 6710, 6810, and 6910 harvesters with 200mm spouts • 113 lbs. 	AZ42610 Abrasion Resistant
K42610BK \$37.85 ea.	13a • Transition Bolt Kit • Use with spout transition #K42610 • One kit required • 3.2 lbs.	
K56941 \$610.00 ea.	13b • Spout transition • To fit all 6650, 6750, 6850, and 6950 harvesters with 200mm spouts • 115 lbs. 	AZ51695/AZ56941 Abrasion Resistant
K56941BK \$37.85 ea.	13c • Transition Bolt Kit • Use with spout transition #K56941 • One kit required • 3.2 lbs.	
K55314 \$725.00 ea.	13d • Spout transition • 166 lbs.  • To fit all 6650, 6750, 6850, and 6950 harvesters equipped with 250mm spouts • Bolt kit: K55314BK , \$37.85 ea.	AZ55314 Abrasion Resistant
K60500 \$18.30 ea.	14 • Spout transition side wall • 3.1 lbs. • To fit all 6000 series harvesters • Hardware Kit: K60500BK , \$9.25 ea., .53 lbs.	Z81903/Z60500 Abrasion Resistant
K43830D \$25.30 ea.	15 • Spout transition inspection door • 3.3 lbs. • To fit all 6000 series harvesters equipped with 200mm spouts	AZ43830 Abrasion Resistant
K20713 \$18.55 ea.	15a • Spout transition inspection door • To fit all 6650, 6750, 6850, and 6950 harvesters equipped with 250mm spouts • 4.8 lbs.	Z20713 Abrasion Resistant
K64131 \$250.75 ea.	16 • Spout ring gear • To fit all 6000 series harvesters with 200mm spout • Made of tool steel for wear resistance • 21.3 lbs.	Z64131
K67194 \$320.80 ea.	16a • Spout ring gear • To fit all 6000 series harvesters with 250mm spout with standard spout turning device • 15.5 lbs.	Z67194 Tool Steel
K73207 \$240.75 ea.	17 • Spout worm gear • 1" bore all the way through • To fit all 6000 series harvesters • 4.3 lbs.	E73207 Heat Treated
K58116SP \$19.05 ea.	18 • Spout Stop • To fit #K42610 spout transition • 1 required • 5.3 lbs.	Z58116
K72114 \$10.00 ea.	18a • Spout stop • To fit #K56941 spout transition • 2 required • 3 lbs.	Z72114



KOOIMA® REPLACEMENT PARTS TO FIT 6000 SERIES JOHN DEERE® 200MM WIDE HI-ARCH SPOUT

Replacement parts produced by Kooima® Company to fit JD® 6000 Series

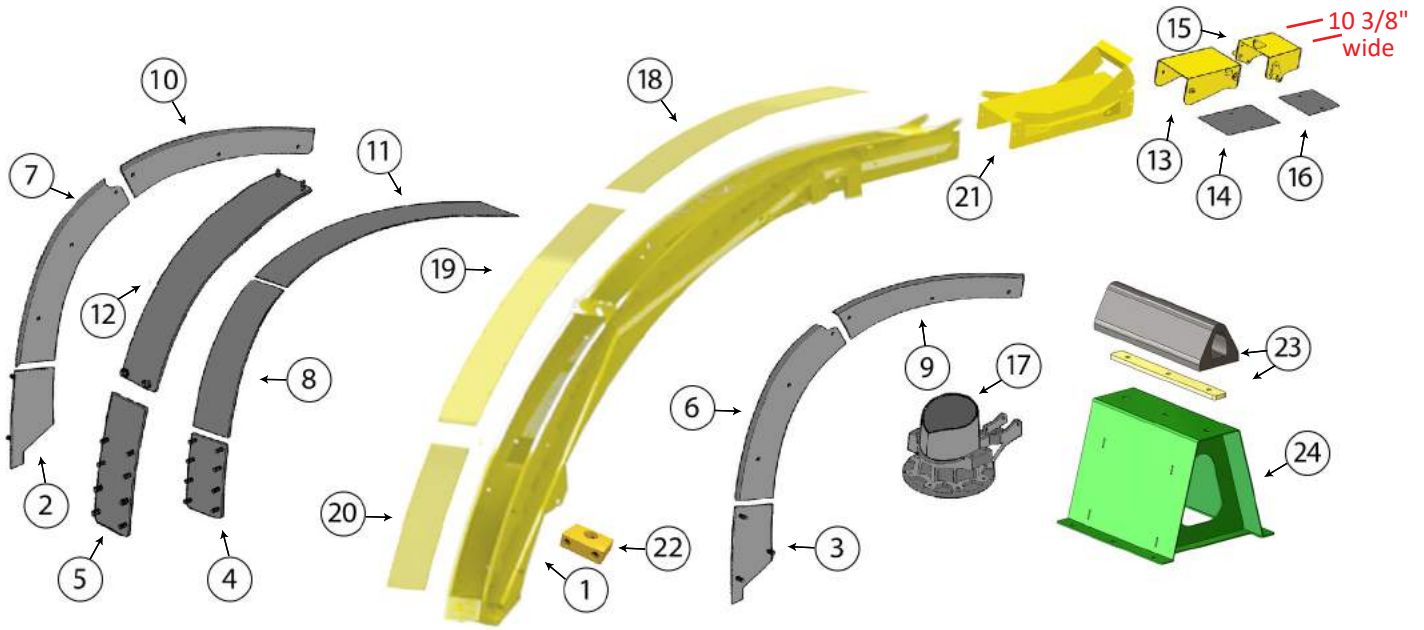

KOOIMA #
K43829

DESCRIPTION

- Hi-arch spout assembly • For top loading trucks and wagons
- Features bolt-on back for easy maintenance • 626 lbs.
- Includes stainless steel and abrasion resistant wear liners
- To fit all 6000 series harvesters equipped with original 200mm wide hi-arch spout
- *Save \$200 if picked up at Kooima® Company!**

REPLACES OEM #
AZ51724/AZ43829

Abrasion Resistant

\$2,575.00

K200mmBK
\$16.05 ea.

①

- Spout liner bolt kit
- **When it's time to replace all the liners, order this bolt kit** • 3.4 lbs.

K48902
\$48.35 ea.

①a

- Right hand spout wear plate • 9 lbs. • **Hardware Kit: K48902BK**, \$4.25, .095 lbs.
- To fit all 6000 series harvesters with 200mm spout • Hardened material

AZ48902
Abrasion Resistant

K48903
\$48.35 ea.

②

- Left hand spout wear plate • 9 lbs. • **Hardware Kit: K48902BK**, \$4.25, .095 lbs.
- To fit all 6000 series harvesters with 200mm spout • Hardened material

AZ48903
Abrasion Resistant

K49299
\$73.45 ea.

③

- Spout wear plate • Includes mounting hardware • 11.7 lbs.
- To fit all 6000 series harvesters equipped with original 200mm wide hi-arch spout
- **Hardware Kit: K49299BK**, \$4.25 ea. .15 lbs. Includes 8 flange nuts

AZ49299
Abrasion Resistant

K49299EX

④

- Extended spout wear plate • **A Kooima® Company exclusive!** • 15.3 lbs.
- Extra length reduces wear on the spout back and liners
- To fit all 6000 series harvesters equipped with original 200mm wide hi-arch spout
- **Hardware Kit: K49299BK**, \$4.25 ea. .15 lbs. Includes 8 flange nuts

AZ49299
Abrasion Resistant

\$105.75 ea.

K62092

⑤

- Lower left hand wear liner • Stainless steel for extra durability
- To fit all 6000 series harvesters equipped with original 200mm wide hi-arch spout • 7.5 lbs. • **Hardware Kit: KLINERBK**, \$6.25, .3 lbs.

Z62092
Stainless Steel

\$95.45 ea.

K62093

⑥

- Lower right hand wear liner • Stainless steel for extra durability
- To fit all 6000 series harvesters equipped with original 200mm wide hi-arch spout • 7.5 lbs. • **Hardware Kit: KLINERBK**, \$6.25, .3 lbs.

Z62093
Stainless Steel

\$95.45 ea.

K62094

⑦

- Lower back liner • Stainless steel for extra durability
- To fit all 6000 series harvesters equipped with original 200mm wide hi-arch spout • **63 5/8" long** • 15.6 lbs.

Z62094
Stainless Steel

\$90.45 ea.

K62095

⑧

- Upper left hand wear liner • Stainless steel for extra durability
- To fit all 6000 series harvesters equipped with original 200mm wide hi-arch spout • 8.5 lbs.

Stainless Steel

\$110.75 ea.

K62096

⑨

- Upper right hand wear liner • Stainless steel for extra durability
- To fit all 6000 series harvesters equipped with original 200mm wide hi-arch spout • 8.5 lbs. • **Hardware Kit: KLINERBK**, \$6.25, .3 lbs.

Stainless Steel

\$110.75 ea.

K62097

⑩

- Top back liner • Stainless steel for extra durability
- **85 1/8" long** • 11.9 lbs.
- To fit all 6000 series harvesters equipped with original 200mm wide hi-arch spout

Stainless Steel

\$110.75 ea.

K51755

⑪

- Optional back liner • Exact replacement of John Deere® spout liner
- Stainless steel for extra durability • **79 1/2" long** • 27 lbs.
- To fit all 6000 series harvesters equipped with original 200mm wide hi-arch spout

AZ51755
Stainless Steel

\$84.45 ea.

K43832D

⑫

- Spout deflector • To fit all 6000 series harvesters equipped with original 200mm wide hi-arch spout • 13.2 lbs.

AZ43832
Abrasion Resistant

\$65.45 ea.

K54380BK

⑬

- Spout deflector bolt kit

\$11.25 ea.

⑬a

- **To fit #K43832D spout deflector** • .35 lbs.

KOOIMA® REPLACEMENT PARTS TO FIT 6000 SERIES JOHN DEERE® 200MM WIDE HI-ARCH SPOUT

Replacement parts produced by Kooima® Company to fit JD® 6000 Series

KOOIMA #		DESCRIPTION	REPLACES OEM #
K43833 \$27.80 ea.	(14)	• Spout deflector wear plate • To fit #K43832D spout deflector • Bolt-in or weld-in • To fit all 6000 series harvesters equipped with original 200mm wide hi-arch spout • 5.3 lbs.	Abrasion Resistant
KBK \$3.25 ea.	(14a)	• Wear plate bolt kit • .1 lbs	
K47896 \$71.95 ea.	(15)	• Spout deflector • 7.3 lbs. • To fit all 6000 series harvesters equipped with original 200mm wide hi-arch spout	AZ47896 Abrasion Resistant
K47896BK \$6.75 ea.	(15a)	• Outer spout deflector bolt kit • To fit #K47896 spout deflector • .15 lbs.	
K47897 \$30.35 ea.	(16)	• Spout deflector wear plate • Bolt-in or weld-in • To fit all 6000 series harvesters equipped with original 200mm wide hi-arch spout • To fit #K47896 spout deflector • 2.8 lbs.	Abrasion Resistant
KBK \$3.25 ea.	(16a)	• Wear plate bolt kit • .1 lbs.	
K51359WL \$77.45 ea.	(17)	• Weld-in transition liner • To fit all 6000 series equipped with original 200mm wide hi-arch spout • 5.9 lbs.	Abrasion Resistant
K43825 \$105.75 ea.	(18)	• Upper rear spout cover • 1 required • 28.5 lbs. • To fit Kooima® hi-arch spout assembly	Abrasion Resistant
K43827 \$105.75 ea.	(19)	• Middle rear spout cover • 1 required • 34 lbs. • To fit Kooima® hi-arch spout assembly	Abrasion Resistant
K43826 \$105.75 ea.	(20)	• Lower rear spout cover • 1 required • 23.5 lbs. • To fit Kooima® hi-arch spout assembly	Abrasion Resistant
K43838 \$195.75 ea.	(21)	• 36" spout extension • Used with 6 or 8-row headers • 44 lbs. • Creates space between head and truck when side or top loading • To fit all 6000 series harvesters equipped with original 200mm wide hi-arch spout	AZ51925 Abrasion Resistant
K54418BK \$9.25 ea.	(21a)	• Spout extension bolt kit • To fit #K43838 spout extension • 1.1 lbs.	
K65925 \$27.80 ea.	(22)	• Block • 2 lbs. • To fit all 6000 series harvesters equipped with original 200mm wide hi-arch spout	HXE38630
K48788 \$95.45 ea.	(23)	• Spout rest support kit • Includes reinforcement bracket and mounting bolts • To fit all 200mm spout rests • 1 required • 7.11 lbs.	Z48788 Z66644
K64700 \$65.45 ea.	(24)	• 200mm spout rest base • 1 required • 17.4 lbs. • To fit all 6000 series with 200mm spouts	Z64700

John Deere® 200mm Low-Arch Spout

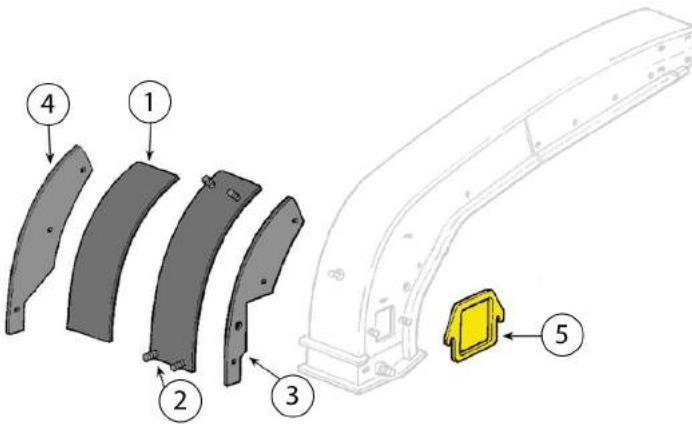

Kooima® 200mm Low-Arch Spout



Order # K70166

Only 
\$2,850⁰⁰ ea.

Complete with liners
Uses high arch spout cylinder

KOOIMA #		DESCRIPTION	REPLACES OEM #
K56761 \$50.00 ea.	(1)	• Wear plate, spout • Hardened material • To fit early 200mm wide low-arch spout • 17.2 lbs.	Z56761 Abrasion Resistant
K51732 \$85.45 ea.	(2)	• Extended spout wear plate • Extra length reduces wear on valuable spouts • Hardened material • Bolt-in installation • To fit 200mm wide low-arch spout • 21 lbs.	AZ51732 Abrasion Resistant
K59892 (Left) \$42.85 ea.	(3)	• Left hand wear plate • 7.2 lbs.	Z59892
K43830 (Right) \$42.85 ea.	(4)	• Right hand wear plate • Hardened material • 8.8 lbs. • To fit 200mm wide low-arch spout	Z43830/Z59893 Abrasion Resistant
K43830D \$25.30 ea.	(5)	• Spout inspection door • To fit all 6000 series harvesters • 3.3 lbs.	AZ43830 Abrasion Resistant

TO ORDER CALL TOLL FREE 1-800-522-8874

KOOIMA®
COMPANY



KOOIMA® REPLACEMENT PARTS TO FIT 6000 SERIES JOHN DEERE® 250MM WIDE HI-ARCH SPOUT

Replacement parts produced by Kooima® Company to fit JD® 6000 Series

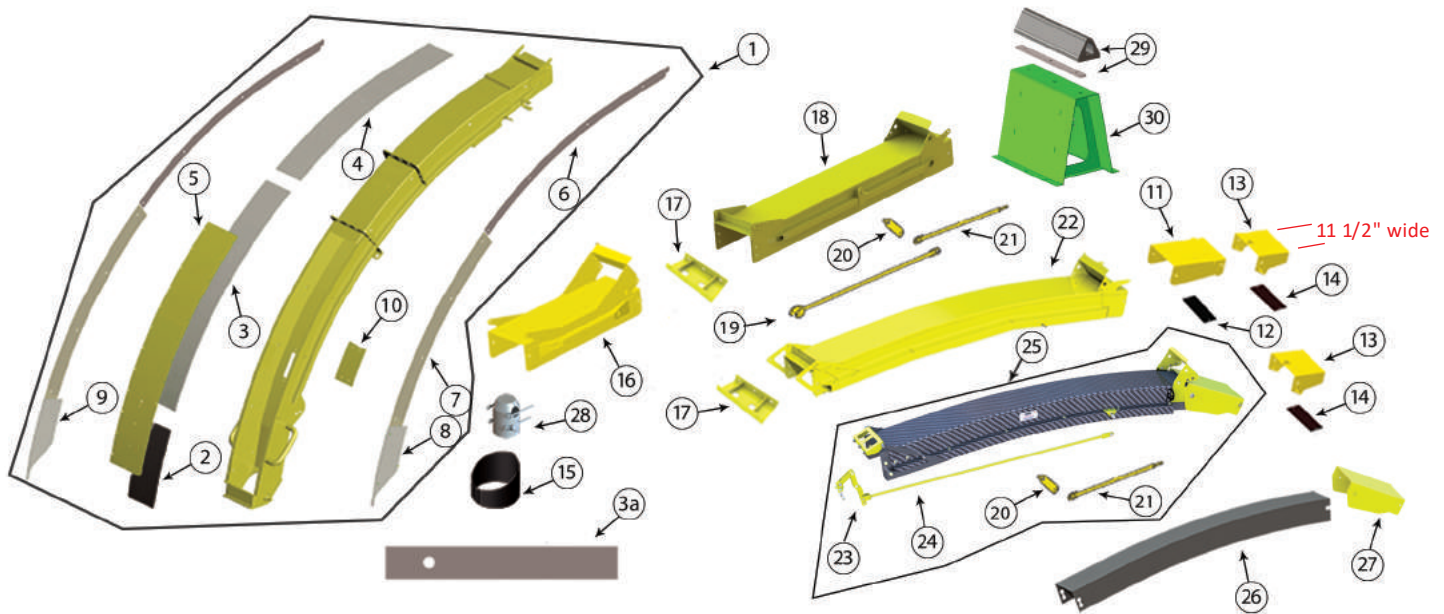

KOOIMA #	DESCRIPTION	REPLACES OEM #
K100830 \$3,100.00	1 • High arch spout • To fit 6000 series equipped with 250mm wide hi-arch spout • 475 lbs • SAVE \$200 when picked up at Kooima® Company!	AZ104282 Abrasion Resistant
K250mmBK \$20.30 ea.	1a • Spout liner bolt kit • When it's time to replace all the liners, order this bolt kit • 3.1 lbs.	
K53231 \$75.45 ea.	2 • Lower spout wear plate • SN. 510523, 648mm long • To fit all 6000 series harvesters • Complete with mounting hardware • 13.8 lbs.	AZ53231 Abrasion Resistant
K53231EX \$105.75 ea.	2a • Extended spout wear plate • Reduces wear on the spout back and liners • To fit all 6000 series harvesters • Complete with mounting hardware • 19.5 lbs	AZ53231 Abrasion Resistant
K103510 \$120.75 ea.	2b • Lower spout wear plate • 848mm long • Complete with mounting hardware • To fit factory JD® spouts SN. 510524 and after • 24.2 lbs.	AZ103510 Abrasion Resistant
K53232 \$79.95 ea.	3 • Lower back spout liner • SN. 510523, 2000mm long • To fit all 6000 series harvesters • 31.2 lbs. • Complete with mounting hardware	AZ53232 Abrasion Resistant
K101740 \$175.75 ea.	3a • Lower back spout liner • 32.3 lbs. • 2000mm long • Before SN. 510524 • To fit all 6000 series equipped with JD® moisture sensor • Complete with mounting hardware	AZ101740 Abrasion Resistant
K103381 \$120.75 ea.	3b • Lower back spout liner • 1800mm long • Complete with mounting hardware • To fit factory JD® spouts SN. 510524 and after • 28.2 lbs.	AZ103381 Abrasion Resistant
K54609 \$79.95 ea.	4 • Upper back spout liner • Complete with mounting hardware • To fit all 6000 series harvesters • 28.7 lbs.	AZ54609 Abrasion Resistant
K100829 \$105.75 ea.	5 • Bolt-on back liner • One required • 55.7 lbs. • To fit all harvesters equipped with Kooima® 250mm spout	Abrasion Resistant
K65656 \$125.00 ea.	6 • Upper side spout liner • Universal, to fit right or left • 4.6 lbs. • To fit all 6000 series harvesters • 2 required • Hardware Kit: KLINERBK, \$6.25, .3 lbs.	Z65656 Stainless Steel
K101661 \$125.75 ea.	6a • Upper side spout liner • To fit factory JD® spouts SN. 510524 and after • 5.8 lbs.	Z101661 Abrasion Resistant
K65657 \$125.00 ea.	7 • Lower side spout liner • Universal, to fit right or left • 6.8 lbs. • To fit all 6000 series harvesters • 2 required • Hardware Kit: KLINERBK, \$6.25, .3 lbs.	Z65657 Stainless Steel
K48903 \$48.35 ea.	8 • Left hand spout wear plate • To fit 6000 series harvesters • 9 lbs. • Hardware Kit: K48902BK, \$4.25, .09 lbs.	AZ48903 Abrasion Resistant
K48902 \$48.35 ea.	9 • Right hand spout wear plate • To fit 6000 series harvesters • 9 lbs. • Hardware Kit: K48902BK, \$4.25, .09 lbs.	AZ48902 Abrasion Resistant
K43921 \$33.85 ea.	10 • Access door • One required • 2.4 lbs. • To fit 6000 series harvesters with 250mm wide hi-arch spout	AZ43921
K54380 \$67.95 ea.	11 • Inner spout deflector • To fit all 6000 series harvesters • 14.6 lbs.	AZ54380 Abrasion Resistant
K54380BK \$11.25 ea.	11a • Inner spout deflector bolt kit • To fit #K54380 spout deflector • .35 lbs.	

KOOIMA® REPLACEMENT PARTS TO FIT 6000 SERIES JOHN DEERE® 250MM WIDE HI-ARCH SPOUT

Replacement parts produced by Kooima® Company to fit JD® 6000 Series

KOOIMA #	DESCRIPTION	REPLACES OEM #
K54381 \$29.30 ea.	(12) • Inner spout deflector wear plate • To fit #K54380 spout deflector • 5.8 lbs.	Abrasion Resistant
KBK \$3.25 ea.	(12a) • Wear plate bolt kit • .1 lbs. • To fit #K54381 spout deflector wear plate	
K53234 \$67.95 ea.	(13) • Outer spout deflector • To fit all 6000 series harvesters • 8 lbs.	AZ53234 Abrasion Resistant
K47896BK \$6.75 ea.	(13a) • Outer spout deflector bolt kit • To fit #K53234 spout deflector • .15 lbs.	
K53235 \$29.30 ea.	(14) • Outer spout deflector wear plate • To fit #K53234 spout deflector • 3.2 lbs.	Abrasion Resistant
KBK \$3.25 ea.	(14a) • Wear plate bolt kit • .1 lbs. • To fit #K53235 spout deflector wear plate	
K54264WL \$79.45 ea.	(15) • Weld-in transition liner • To fit all 6000 series harvesters • 8 lbs.	Abrasion Resistant
K54418 \$165.75 ea.	(16) • 36" spout extension • To fit all 6000 series harvesters • 39 lbs.	AZ104285/AZ54418/AZ59970 Abrasion Resistant
K54418BK \$9.25 ea.	(16a) • Spout extension bolt kit • To fit #K54418 & #K104288 spout extensions • 1.1 lbs.	
K104293 \$61.20 ea.	(17) • Spout stiffener bracket • Needed with 5' and 7' extensions • To fit all 6000 series harvesters • 4.1 lbs.	AZ104293
K104293BK \$32.85 ea.	(17a) • Bolt kit • To fit #K104293 bracket • 1 lb.	
K104288 \$615.80 ea.	(18) • 5' extension for a 250mm wide hi-arch spout • To fit all 6000 series harvesters • 67 lbs. • Uses K104291, K104292 & K104290 linkage pieces	AXE25112 / AZ104288
K54418BK \$9.25 ea.	(18a) • Spout extension bolt kit • To fit #K104288 spout extension • .2 lbs.	
K104291 \$40.35 ea.	(19) • Replacement 5' extension link • To fit all 6000 series harvesters • 2.45 lbs.	AZ104291
K104292 \$30.35 ea.	(20) • Replacement lever for the 5' extension • To fit all 6000 series harvesters • .65 lbs.	AZ104292
K104292BK \$9.75 ea.	(20a) • Bolt kit • .2 lbs. • To fit #K104292 replacement lever	
K104290 \$35.35 ea.	(21) • Replacement 5' extension link • To fit all 6000 series harvesters • 1.65 lbs.	AZ104290
K7FTSP \$1,250.00 ea.	(22) • 7' steel extension for 250mm wide high arch spout • 97 lbs. • Uses FH5001062, FH5001059, K104292 & K104290 linkage pieces	
FH5001062 \$125.75 ea.	(23) • Replacement 7' extension actuator • Use with K7FTSP & K22416CF 7' extensions • To fit all 6000 series harvesters with 250mm wide high arch spout • 2.9 lbs.	
FH5001059 \$55.35 ea.	(24) • Replacement 7' extension link • Use with K7FTSP & K22416CF 7' extensions • To fit all 6000 series harvesters with 250mm wide high arch spout • 3.4 lbs.	
K22416CF \$2,750.00	(25) • Carbon fiber 7' spout extension • US PATENT 9,198,350 & 9,326,445 • Curved to optimize crop flow • Only 45 lbs. hardware included! • 1 piece liner • Light weight, abrasion resistant spout deflectors • Comes complete with inner deflector and linkage pieces • Do not install on worn or damaged spout base	AZ22416
FH5001046 \$260.75 ea.	(26) • Replacement carbon fiber spout extension center liner • High wear UHMW plastic • 14 lbs.	
FH5001069 \$65.45 ea.	(27) • Carbon fiber spout extension inner deflector • Optional steel version • 16 lbs.	
K250EXT \$80.45 ea.	(28) • 250mm spout cylinder extension • 4 lbs. • Gain up to 18" additional height on spout • Fill the back of the semi trailer when opening the field • A real must when using a 5' or longer extension!	
K69635 \$95.45 ea.	(29) • Spout rest support kit • 9.5 lbs. • Includes reinforcement bracket and mounting bolts • To fit all 250mm spout rests	Z69635 Z70507
K61312 \$90.45 ea.	(30) • 250mm spout rest base • 26.5 lbs. • To fit all 6000-7000 series with 250mm spouts • 1 required	AZ61312

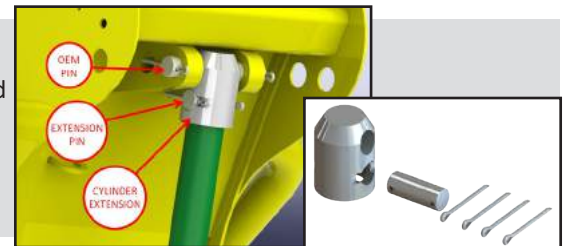

Order online at WWW.KOOIMA.COM and receive **FREE FREIGHT** to your door!

KOOIMA® REPLACEMENT PARTS TO FIT 6000 SERIES JOHN DEERE® 250MM WIDE LOW-ARCH SPOUT

Replacement parts produced by Kooima® Company to fit JD® 6000 Series

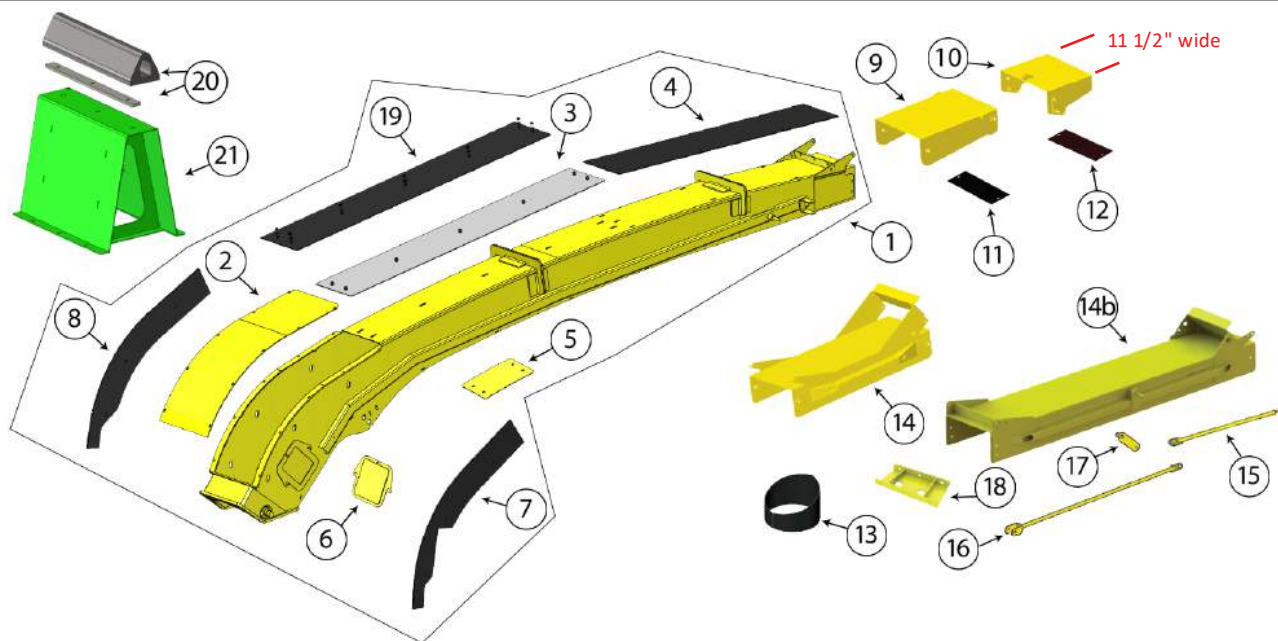

KOOIMA #	DESCRIPTION	REPLACES OEM #
K62973 \$3,100.00 ea.	① • Low arch spout • Uses high arch spout cylinder • To fit all 6000 series harvesters • 400 lbs.	AZ101238 / AZ62973 Abrasion Resistant
K68680 \$97.45 ea.	② • Lower spout wear plate • To fit 6000 series harvesters with 250mm wide low-arch spout • 29.4 lbs. • Bolt Kit: K68680BK , \$17.30 ea., .5 lbs.	Z68680 Abrasion Resistant
K62973LINF \$90.45 ea.	③ • Upper rear spout wear plate • To fit 6000 series harvesters with 250mm wide low-arch Kooima® spout • 24.4 lbs.	Abrasion Resistant
K62973LINB \$70.45 ea.	④ • Top rear spout liner • 1 required • 20.7 lbs. • To fit 250mm wide low-arch Kooima® spouts	Abrasion Resistant
K43921 \$33.85 ea.	⑤ • Access door • One required • 2.4 lbs. • To fit 6000 series harvesters with 250mm wide low-arch spout	AZ43921
K43830D \$25.30 ea.	⑥ • Spout transition inspection door • 3.3 lbs. • To fit all 6000 series harvesters equipped with 200mm spouts	AZ43830 Abrasion Resistant
K68683 (Left) K68684 (Right) \$50.35 ea.	⑦ • Wear plate • To fit 6000 series harvesters with 250mm wide low-arch spout	Z68683 Z68684 Abrasion Resistant
K68683BK \$6.00 ea.	⑧a • Wear plate bolt kit • .32 lbs. • To fit K68683 and K68684 wear plate	
K54380 \$67.95 ea.	⑨ • Inner spout deflector • To fit 6000 series harvesters with 250mm wide low-arch spout • 14.6 lbs.	AZ54380 Abrasion Resistant
K54380BK \$11.25 ea.	⑨a • Inner spout deflector bolt kit • To fit #K54380 spout deflector • .35 lbs.	
K53234 \$67.95 ea.	⑩ • Outer spout deflector • To fit 6000 series harvesters 250mm wide low-arch spout • 8 lbs.	AZ53234 Abrasion Resistant
K47896BK \$6.75 ea.	⑩a • Outer spout deflector bolt kit • To fit #K53234 spout deflector • .15 lbs.	
K54381 \$29.30 ea.	⑪ • Inner spout deflector wear plate • To fit #K54380 spout deflector • Bolt-in or weld-in • 5.8 lbs.	Abrasion Resistant
KBK \$3.25 ea.	⑪a • Wear plate bolt kit • .1 lbs. • To fit #K54381 spout deflector wear plate	
K53235 \$29.30 ea.	⑫ • Outer spout deflector wear plate • To fit #K53234 spout deflector • Bolt-in or weld-in • 3.2 lbs.	Abrasion Resistant
KBK \$3.25 ea.	⑫a • Wear plate bolt kit • .1 lbs. • To fit #K53235 spout deflector wear plate	
K54264WL \$79.45 ea.	⑬ • Weld-in transition liner • To fit all 6000 series harvesters • 8 lbs.	Abrasion Resistant
K54418 \$165.75 ea.	⑭ • 36" spout extension • Used with 6 or 8-row headers • Creates space between head and truck when side or top loading • To fit 6000 series equipped w/ a 250mm wide low-arch spout • 39 lbs.	AZ104285 AZ54418 AZ59970 Abrasion Resistant

KOOIMA® REPLACEMENT PARTS TO FIT 6000 SERIES JOHN DEERE® 250MM WIDE LOW-ARCH SPOUT

Replacement parts produced by Kooima® Company to fit JD® 6000 Series

KOOIMA #	DESCRIPTION	REPLACES OEM #
K54418BK \$9.25 ea.	(14a) • Spout extension bolt kit • To fit #K54418 & #K104288 spout extensions • 1.1 lbs.	
K104288 \$615.80 ea.	(14b) • 5' extension for 250mm spouts • Does not replace end section on JD® OEM spouts • To fit all 6000 series harvesters • 67 lbs.	AZ104288 AXE25112
K104290 \$35.35 ea.	(15) • Replacement 5' extension link • To be used with K104288 • To fit all 6000 series harvesters • 1.65 lbs.	AZ104290
K104291 \$40.35 ea.	(16) • Replacement 5' extension link • To be used with K104288 • To fit all 6000 series harvesters • 2.45 lbs.	AZ104291
K104292 \$30.35 ea.	(17) • Replacement lever for the 5' extension • To be used with K104288 • To fit all 6000 series harvesters • .65 lbs.	AZ104292
K104292BK \$9.75 ea.	(17a) • Bolt kit • .2 lbs. • To fit #K104292 replacement lever	
K104293 \$61.20 ea.	(18) • Spout stiffener bracket • To fit all 6000 series harvesters • Supports K104288 5' extension • 4.1 lbs.	AZ104293
K104293BK \$32.85 ea.	(18a) • Bolt kit • To fit #K104293 bracket • 1 lb.	
K54608 \$95.00 ea.	(19) • Upper rear spout wear plate • To fit 6000 series harvesters with factory John Deere® spout • 24.7 lbs.	AZ54608 Abrasion Resistant
K69635 \$95.45 ea.	(20) • Spout rest support kit • Includes reinforcement bracket and mounting bolts • To fit all 250mm spout rests	Z69635 Z70507
K61312 \$90.45 ea.	(21) • 250mm spout rest base • 26.5 lbs. • To fit all 6000-7000 series with 250mm spouts • 1 required	AZ61312
K48788BR \$95.45 ea.	• Rear rubber bumper • 13.75" long • To fit all 6000 & 7000 series • 2 required	Z48788



HAY PICK-UP TEETH

HP hay pick-up teeth are "shot peened," giving them added strength!

- Pick-up tooth • .45 lbs.
- To fit all John Deere® 630, 645, 630A, 640A, 645A, 630B, 640B, 645B, 630C, 640C & 645C forage harvester hay heads
- Replaces OEM #CC25176

Order # K25176
\$3⁹⁵ ea.

Order # K25176HP
\$5³⁵ ea.

Bolt Kit: K25176BK: \$2.75 ea.



- Pick-up tooth
- To fit all John Deere® 5 1/2 ft. forage heads
- Replaces OEM #268SE
- .35 lbs.

Order # K268SE
\$2⁰⁵ ea.

Bolt Kit: K268SEBK: \$4.25 ea.



- Pick-up tooth • .45 lbs.
- To fit all John Deere® 7 1/2 ft. forage harvester hay heads after SN. 550001
- Replaces OEM #E74678

Order # K74678
\$2²⁰ ea.

Bolt Kit: K74678BK: \$3.50 ea.



- Poly Pick-up stripper - Complete with hardware
- 1/2" thick with 1/4" thick reinforced support ring
- To fit John Deere® 630A, 640A, 645A, 630B, 640B, 645B, 630C, 640C & 645C hay heads • 1.2 lbs.
- Replaces OEM # FH311772 / E85043

Order # K85043
\$30²⁵ ea.

Additional Bolt Kit: K85043BK
\$3.50 ea. One required per band

TO ORDER CALL TOLL FREE 1-800-522-8874

KOOIMA®
COMPANY



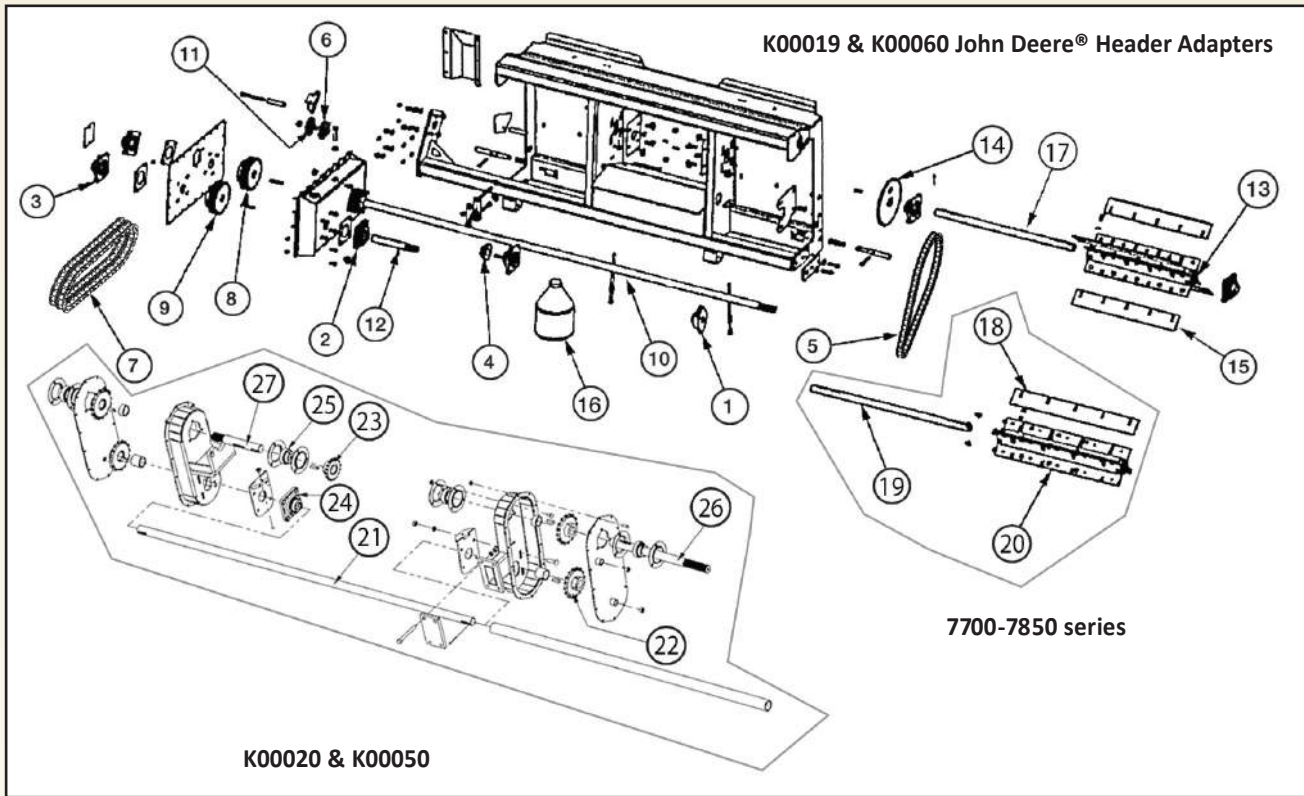

	KOOIMA #	PRICE	DESCRIPTION
①	15-2BOLT	\$50.35 ea.	• Bearing 1.50", 2 bolt flange • 3.6 lbs.
②	15-4BOLT	\$50.35 ea.	• Bearing Ø 1.50", 4-bolt flange, set screw • 4.5 lbs.
③	15-4BOLT-LC	\$75.45 ea.	• Bearing Ø 1.50", 4-bolt flange, lock collar • 4.75 lbs.
④	60B15-150	\$18.80 ea.	• Sprocket #60 15 tooth 1.5" finished bore keyed • 1.9 lbs.
⑤	60H-54	\$40.35 ea.	• #60 heavy roller chain, 54 pitches • 4.2 lbs.
⑥	80A11	\$50.35 ea.	• Idler sprocket #80 11 tooth • 1.2 lbs.
⑦	80D-46	\$60.45 ea.	• 80 double roller chain, 46 pitches • 13.4 lbs.
⑧	D80B20H1.5	\$215.75 ea.	• Double sprocket #80 B-style 20 tooth hardened 1-1/2" ID • 17.2 lbs.
⑨	D80B21H1.5	\$215.75 ea.	• Double sprocket #80 21 tooth hardened tapered bore • 18.6 lbs.
⑩	FH002140	\$195.75 ea.	• Long shaft • 53.8 lbs.
⑪	FH002158	\$25.30 ea.	• Idler sprocket spacer • .1 lbs.
⑫	FH002181	\$135.75 ea.	• Rear drive shaft, alt • 4.8 lbs.
⑬	FH5000925	\$225.75 ea.	• Feed roll weldment • 41.8 lbs.
⑭	FH5000926	\$55.00 ea.	• Welded sprocket #60 42 teeth 1-1/2" bore keyed • 10.5 lbs.
⑮	FH002147	\$22.30 ea.	• Feed roll bolt-on fin • 4 required • 5.6 lbs.
⑯	OILAGMA5EP	\$45.35 ea.	• 1 gal AGMA 5EP gear oil • 7.85 lbs.
⑰	FH002142	\$45.35 ea.	• Feed roll center shaft, JD® 6610-7550 • 17 lbs.

John Deere® 7700-7850 replacement parts below

⑱	FH002239	\$19.80 ea.	• Feed roll bolt-on fin • 6.8 lbs.
⑲	FH002240	\$105.75 ea.	• Feed roll center shaft, JD® 7700-7850 • 19 lbs.
⑳	FH5000935	\$215.75 ea.	• Feed roll weldment, JD® 7700-7850

K00020 & K00050 replacement parts below

㉑	FH001741	\$125.75 ea.	• Drive shaft for 6000 series machines (K00020) • 33 lbs.
㉑a	FH002099	\$125.75 ea.	• Drive shaft for 7000 series machines (K00050) • 41 lbs.
㉒	FH500065	\$29.30 ea.	• 16 tooth #80 drive assembly • 3.6 lbs.
㉓	FH500064	\$35.35 ea.	• 16 tooth #60 drive assembly • 2 lbs.
㉔	VJC17-16	\$60.45 ea.	• 1 7/16 ID FLG MT assembly • 3.4 lbs.
㉕	RA107RRBAG	\$60.45 ea.	• 1 7/16" bearing & collar • 1 lb.
㉖	FH002101	\$65.45 ea.	• Drive shaft #2 • 9.25 lbs.
㉗	FH002100	\$42.35 ea.	• Drive shaft #1 • 4.3 lbs.
㉘	60D-16	\$25.30 ea.	• 60 chain double strand 16 pitch .8 lbs.
㉙	80CHAIN-38	\$17.80 ea.	• 80 roller chain 38 pitches w/con. • 5.4 lbs.

Truck icon signifies product is shipped via truck freight.

TO ORDER BY FAX CALL 1-712-476-6283

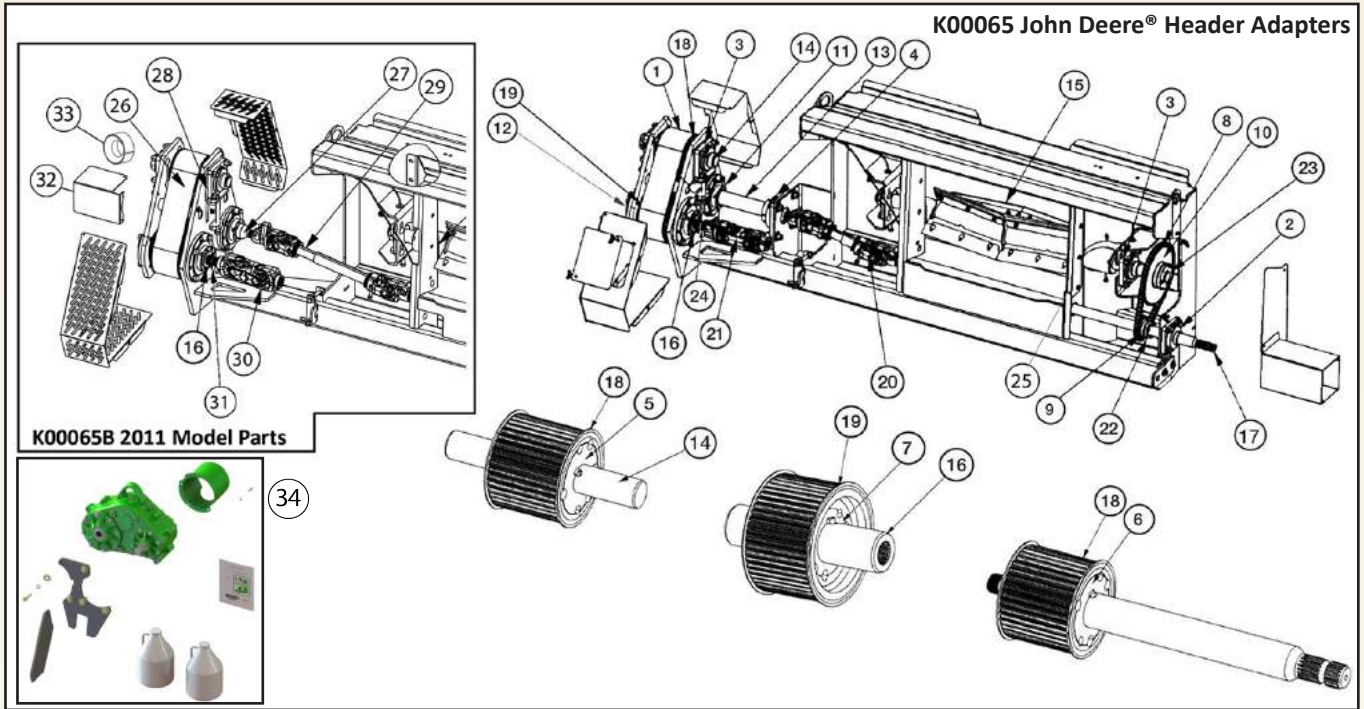

	KOOIMA #	PRICE	DESCRIPTION
1	14-MGT-1400-125	\$750.80 ea.	• 2010 model belt, 1400mm long, 125mm wide, 14mm pitch • 2.95 lbs.
2	175-4BOLT-LC	\$80.45 ea.	• Bearing, ball, 4-bolt flange, lock collar, 1.75 shaft, sxv series • 5.4 lbs.
3	20-4BOLT-LC	\$115.00 ea.	• Bearing, ball, 4-bolt flange, lock collar, 2.00 shaft • 7.15 lbs.
4	244-4BOLT-LC	\$160.75 ea.	• Bearing, ball, 4-bolt flange, lock collar, 2.44 shaft • 11.8 lbs.
5	3535X2	\$85.45 ea.	• Taper-lock bushing, 2.00 shaft, #3535 • 13.3 lbs.
6	3535X207	\$85.45 ea.	• Taper-lock bushing, 2.44 shaft, #3535 • 11.8 lbs.
7	3535X3	\$85.45 ea.	• Taper-lock bushing, 3.00 shaft, #3535 • 9.6 lbs.
8	60H-58	\$45.35 ea.	• #60 heavy roller chain, 58 pitches • 4.5 lbs.
9	60P16H	\$65.45 ea.	• Squeeze-style sprocket, #60 16 tooth, hardened • 1.9 lbs.
10	60SF45	\$110.75 ea.	• #60 sprocket, 45 tooth, QD hub • 12.1 lbs.
11	FC-IP-207R	\$375.80 ea.	• Bearing, roller, Imperial, piloted flange, 2.43 shaft • 13.4 lbs.
12	FC-IP-300R	\$600.00 ea.	• Bearing, roller, Imperial, piloted flange, 3.00 shaft • 18.9 lbs.
13	FH002596	\$140.75 ea.	• Short shaft, driven • 29.6 lbs.
14	FH002607	\$85.45 ea.	• Idler shaft • 12.6 lbs.
15	FH002614	\$35.35 ea.	• Bolt-on tooth, JD® • 4 required • 4.9 lbs.
16	FH002621	\$185.75 ea.	• Input shaft for both K00065 and K00065B • 15.9 lbs.
17	FH002803	\$200.75 ea.	• Long shaft • 42.1 lbs.
18	GTR-38G-14-125	\$375.80 ea.	• Sprocket Falcon 38-tooth, 14mm pitch, 125mm width • 17.3 lbs.
18a	FL14MM40	\$22.80 ea.	• Flange for 14MX-38S-125 • 2 required per sprocket • .65 lbs.
19	GTR-50G-14-125	\$425.80 ea.	• Sprocket Falcon 50-tooth, 14mm pitch, 125mm width • 42.9 lbs.
19a	FL32XH	\$22.80 ea.	• Flange for 14MX-50S-125 • 2 required per sprocket • .8 lbs.
20	K00065PTO	\$350.80 ea.	• Captive PTO for JD® wide adapter • 19.5 lbs.
21	K23TO21HF	\$415.80 ea.	• JD® adapter drive PTO - 1.38-21 to 1.50-23, K00065 • 14.6 lbs.
22	P11.75	\$35.35 ea.	• P1 bushing, for 1.75 shaft • .7 lbs.
23	SFX2.0	\$25.30 ea.	• QD bushing, 2.00 shaft • 4 lbs.
24	FH002350	\$90.45 ea.	• 1 3/8" 21 spline to 1 3/4" 20 spline shaft, 2010 model shaft • 4.55 lbs.
25	FH002799	\$50.35 ea.	• Right side filler plate, wide throat machines • 9 lbs.
K00065B replacement parts below			
26	14-MGT-1568-125	\$875.80 ea.	• Gates® GT carbon belt, 1568mm long, 125mm wide, 14mm pitch • 5 lbs.
27	FH002944	\$175.75 ea.	• Front shaft, driven • 19.16 lbs.
28	FH002945	\$20.30 ea.	• Bearing backing plate • 2 required
29	K00065PTOLONG	\$390.80 ea.	• Captive PTO • 27.14 lbs.
30	K23TO23MALE	\$490.00 ea.	• W2500 input PTO - 1.50-23 to 1.50-23 • 18.6 lbs.
31	FH002943	\$175.00 ea.	• 1 1/2" 23 spline to 1 3/4" 20 spline shaft • 4.85 lbs.
32	FH003155	\$13.30 ea.	• LH PTO shield • 3 lbs.
33	FH002925	\$26.05 ea.	• Load-bearing collar • 1 required • 1 lb.
34	K00065TO75KIT	\$2,600.00 ea.	• Gear box conversion kit • Use this kit to convert your belt drive adapter to the new style enclosed gear box

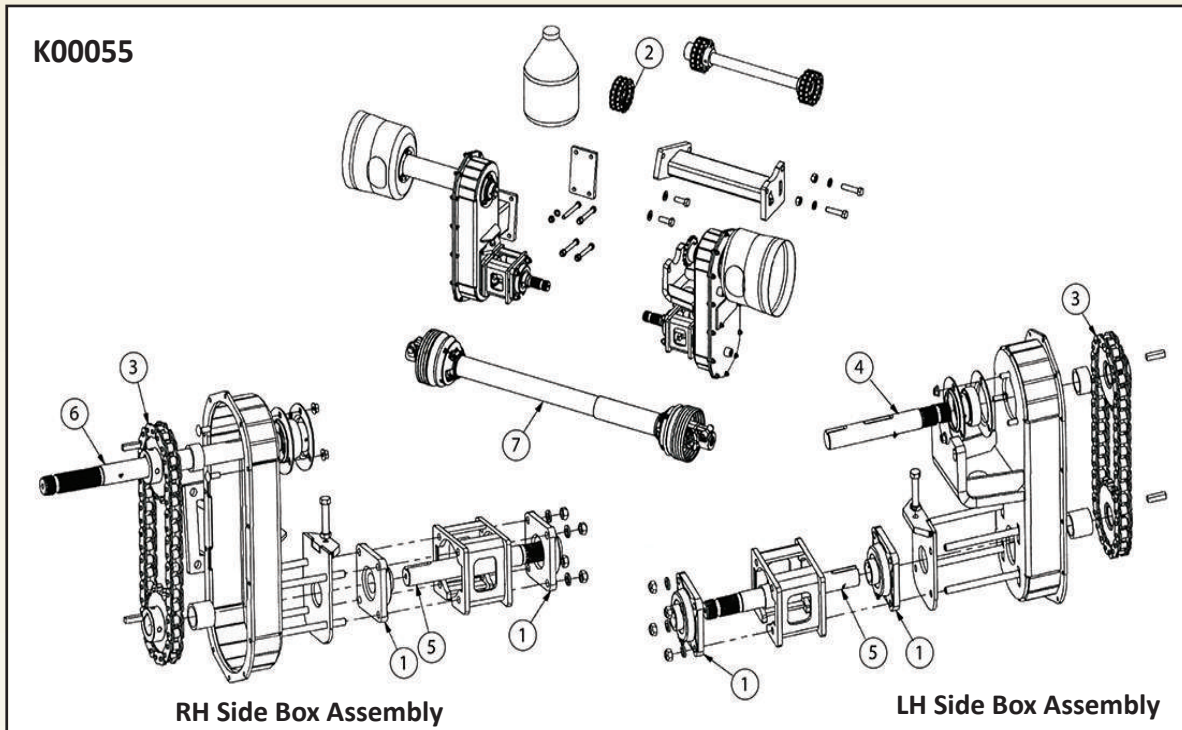

	KOOIMA #	PRICE	DESCRIPTION
①	14-4BOLT-LC	\$50.35 ea.	• Bearing Ø 1.43", 4-bolt flange, set screw • 3.3 lbs.
②	60D-16	\$25.30 ea.	• Double 60 connection chain • .8 lbs.
③	80CHAIN-40	\$25.30 ea.	• #80 roller chain 40 pitches • 3.2 lbs.
④	FH002100	\$42.35 ea.	• Drive shaft # 1 • 4.3 lbs.
⑤	FH002706	\$65.45 ea.	• Drive shaft, bottom • 6.2 lbs.
⑥	FH002708	\$30.00 ea.	• Drive shaft, RH • 8.95 lbs.
⑦	K00055PTO	\$350.80 ea.	• PTO shaft • 45" collapsed length, 1 3/8 21 spline clamp ends • 38.5 lbs.



The Rock Stop'er Pro

FORAGE HARVESTER STONE DETECTION SYSTEM



JD® must have double spring kit installed.

- Fits most makes and models of SPFH and pull type harvesters.
- Patented Inertia sensor stops feed drive when rocks are detected.
- In cab sensitivity adjustment for varying crop conditions.
- Call 1-800-522-8874 for more details!



Extra Sensor Available!

Order # SENSOR
Only \$750⁸⁰ ea.

Order # ROCK STOPER
Only \$2,950⁰⁰ ea.



Designed and manufactured in Canada.

Truck icon signifies product is shipped via truck freight.

TO ORDER BY FAX CALL 1-712-476-6283

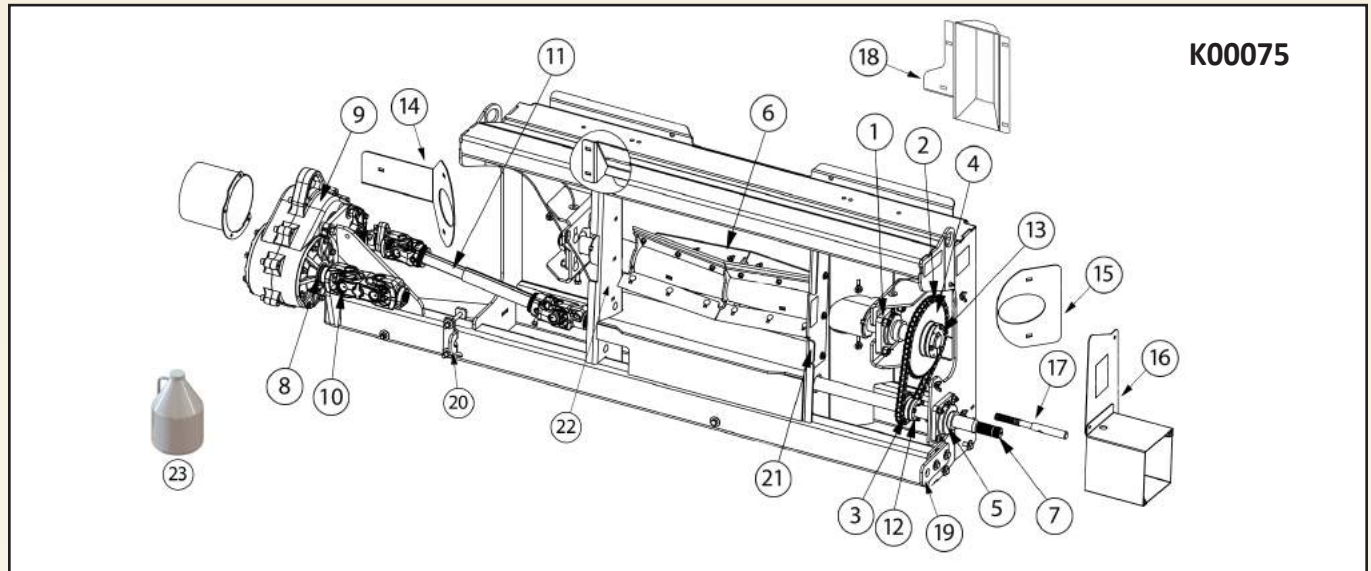

K00075

KOOIMA #	PRICE	DESCRIPTION
① 20-4BOLT-LC	\$115.00 ea.	• Ball Bearing, 4-bolt flange, lock collar, 2.00" shaft • 7.15 lbs. • 2 required
② 60H-58	\$45.35 ea.	• #60 Heavy roller chain, 58 pitches • 4.5lbs.
③ 60P16H	\$65.45 ea.	• Squeeze style sprocket, #60 16 tooth, hardened • 1.9 lbs.
④ 60SF45	\$110.75 ea.	• #60 sprocket, 45 tooth, QD hub • 12.1 lbs.
⑤ 175-4BOLT-LC	\$80.45 ea.	• Ball bearing, 4-bolt flange, lock collar, 1.75" shaft • 5.4 lbs. • 2 required
⑥ FH002614	\$35.35 ea.	• Bolt on tooth, JD® • 4.9 lbs. • 4 required
⑦ FH002803	\$200.75 ea.	• Long shaft • 42.1 lbs.
⑧ FH002943	\$175.00 ea.	• 1-1/2" 23 spline to 1-3/4" 20 spline shaft • 4.85 lbs.
⑨ FH003620	\$2,400.00 ea.	• Parallel gearbox, 1.3:1 ratio 🚚
⑩ K23TO23MALE	\$490.00 ea.	• W2500 input PTO, 1-1/2" 23 spline to 1-1/2" 23 spline • 18.6 lbs.
⑪ K00065PTOLONG	\$390.80 ea.	• Captive PTO • 27.14 lbs.
⑫ P11.75	\$35.35 ea.	• P1 Bushing, for 1-3/4" shaft • .7 lbs.
⑬ SFX2.0	\$25.30 ea.	• QD Bushing, 2.00" shaft • 4 lbs.
⑭ FH002660	\$15.30 ea.	• LH Inside cover • 1 required • 5.25 lbs.
⑮ FH002659	\$7.25 ea.	• RH Inside cover • 1 required • 2.8 lbs.
⑯ FH002661KIT	\$25.30 ea.	• RH Drive cover • 1 required • 13.75 lbs.
⑰ FH002175	\$17.30 ea.	• Locking pin • 2 required • 1.5 lbs.
⑱ FH002657	\$32.85 ea.	• Sprocket cover • 1 required • 5.2 lbs.
⑲ FH002124	\$6.25 ea.	• RH Pin plate • 1 required • 2.2 lbs.
⑳ FH002619KIT	\$15.80 ea.	• LH Connecting plate kit • 1 required • 4.5 lbs.
㉑ FH002799	\$50.35 ea.	• Right side filler plate, wide throat machines • 9 lbs.
㉑a FH5000974	\$50.35 ea.	• Right side filler plate, narrow throat machines • 9 lbs. • Used on K00065 also
㉒ FH5000975	\$50.35 ea.	• Left side filler plate, narrow throat machines • 9 lbs.
㉓ 75W-90PS	\$13.00 ea.	• 1 quart oil • 7 quarts needed • 2 lbs./qt.

John Deere® 6000 & 7000 Series Header Adapter

The adapter work horse, this adapter will allow you to gain the ground speed to get your job done faster. With the improved crop flow design and enclosed heavy duty gear box this is the most efficient header adapter on the market today. This adapter will work with John Deere® 600 series (excluding 606C) 40 and 90 series corn heads and has the ability to switch between narrow and wide throat harvesters easily.

Order # K00075

\$12,500⁰⁰ ea.

Patent # 8,376,126



KOOIMA® REPLACEMENT PARTS TO FIT 7200-7580 SERIES JOHN DEERE® FORAGE HARVESTERS

John Deere® and JD® are registered trademarks of Deere & Company, which does not manufacture, distribute or endorse these parts.

Replacement parts produced by Kooima® Company to fit JD® 7000 Series

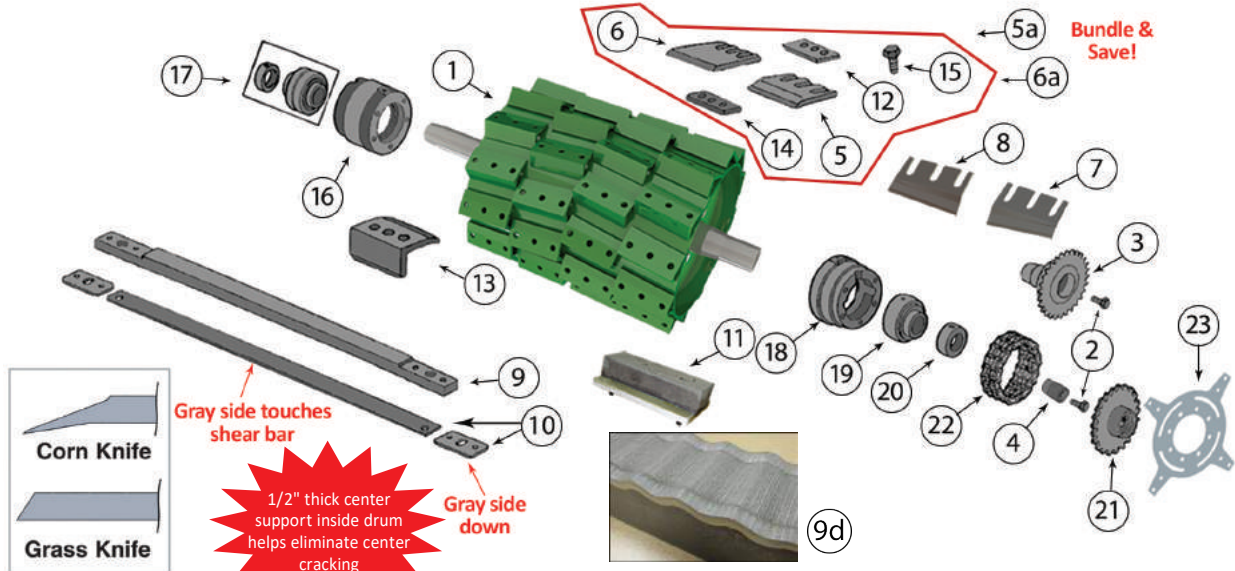



KOOIMA #	DESCRIPTION	REPLACES OEM #
K103888 \$3,910.00 ea.	① • 40 knife drum • 563 lbs.	AZ103888
K101200 \$4,110.00 ea.	①a • To fit 7200-7580 harvesters • Will need to order K71387 Hub & K19M8610 Bolt	AZ101200
K101199 \$4,150.00 ea.	①b • 48 knife drum • Angled knife brackets • 592 lbs.	AZ101199
K19M8610 \$6.00 ea.	② • 56 knife drum • Straight knife brackets • 628 lbs.	19M8610
K71882 \$275.75 ea.	③ • Bolt	19M8610
K71387 \$37.35 ea.	④ • Used for K71387 splined hub and K71882 sprocket • .5 lbs.	19M8610
K63136 \$18.20 ea.	⑤ • 28 tooth sprocket • 8.3 lbs.	AZ71882
K63136KIT \$39.10 ea.	⑤a • To fit 7200-7500 series SN. 506847 & up • Also fits all 7250-7550 machines	71387
K63136HP \$23.50 ea.	⑤b • Splined hub • 2.1 lbs	71387
K69500 \$16.70 ea.	⑥ • To fit all 7200-7500 series SN. 506846 & lower • Uses the K71139 sprocket	Z63136/Z56647
K69500KIT \$37.70 ea.	⑥a • Corn knife • To fit all 7200-7580 series harvesters	Z63136/Z56647
K69500HP \$20.05 ea.	⑥b • Wider design for fewer unchopped leaves • 48 required • 1.4 lbs. Heat Treated/Tungsten Carbide	Z63136
K62075 \$22.90 ea.	⑦ • Kit Includes (1) K63136, (1) K49623, (1) K71196, (3) K69650	Z63136
K62075HP \$26.55 ea.	⑦a • Save \$ when buying the kit! • 4 lbs./ kit	Z63136
K62076 \$22.90 ea.	⑦b • Hi-performance corn knife • Lasts longer than factory OEM knives • 1.5 lbs. Heat Treated/Tungsten Carbide	Z63136
K62076HP \$26.55 ea.	⑦a • Thicker Tungsten carbide edge	Z63136
K53906 \$560.00 ea.	⑧ • New longer grass knife • To fit all 7200-7580 series harvesters • 1.6 lbs. Heat Treated/Tungsten Carbide	Z69500
K53906HP \$660.00 ea.	⑧a • Reduces knife breakage by providing more knife to angle bearing surface Heat Treated/Tungsten Carbide	Z69500
K53905 \$450.00 ea.	⑧b • Kit includes (1) K69500, (1) K49623, (1) K71196, (3) K69650	Z69500
K64735HPBK \$19.80 ea.	⑧c • Save \$ when buying the kit! • 4 lbs/kit	Z69500
K53906DSW \$1,175.00 ea.	⑧d • Hi-performance grass knife • 1.6 lbs. Heat Treated/Tungsten Carbide	Z69500
K49450 \$60.45 ea.	⑨ • Thicker tungsten carbide edge	Z69500
	⑨a • Angled corn knife • Right hand	Z62075
	⑨b • To fit all 7200-7580 series • 1.5 lbs. Heat Treated/Tungsten Carbide	Z62075
	⑨c • High performance angled corn knife • Right hand • 1.5 lbs. Heat Treated/Tungsten Carbide	Z62075
	⑨d • To fit all 7200-7580 series • Thicker tungsten carbide edge Heat Treated/Tungsten Carbide	Z62075
	⑩ • Angled corn knife • Left hand	Z62076
	⑩a • To fit all 7200-7580 series • 1.5 lbs. Heat Treated/Tungsten Carbide	Z62076
	⑩b • High performance angled corn knife • Left hand • 1.5 lbs. Heat Treated/Tungsten Carbide	Z62076
	⑩c • To fit all 7200-7580 series • Thicker tungsten carbide edge Heat Treated/Tungsten Carbide	Z62076
	⑩d • Corn shearbar, 36mm thick	AZ53906
	⑪ • To fit all 7200-7580 series harvesters • 29.4 lbs. Heat Treated/Tungsten Carbide	AZ53906
	⑫ • High performance shearbar	AZ53906
	⑬ • To fit all 7200-7580 series harvesters • 30.7 lbs. Heat Treated/Tungsten Carbide	AZ53906
	⑭ • Grass shearbar, 36mm thick	AZ53905/AZ103112
	⑮ • To fit all 7200-7580 series harvesters • 29.5 lbs. Heat Treated/Tungsten Carbide	AZ53905/AZ103112
	⑯ • Shearbar bolt kit • 1.65 lbs.	AZ53906
	⑰ • To fit K53906, K53906HP, K53905 & K64735HP	AZ53906
	⑱ • Koyma Klad® hi-performance double sine wave shearbar • Patent # 8,109,176	AZ53906
	⑲a • To fit 7200-7500 series harvesters • Maximize your shear bar's cutting surface!	AZ53906
	⑲b • Koyma Klad® coating maintains a long lasting sharp edge for more tons per hour • 30.4 lbs.	AZ53906
	⑲c • Shearbar wear strip kit • To fit all 7200-7580 series harvesters	E72350/Z49449
	⑲d • Includes (1) #K49449 long wear strip & (2) #K72350 short wear strips	E72350/Z49449
	⑲e • Gray side of wear strip always touching shear bar • 1 kit required • 1.3 lbs.	E72350/Z49449

TO ORDER BY FAX CALL 1-712-476-6283

KOOIMA® REPLACEMENT PARTS TO FIT 7200-7580 SERIES JOHN DEERE® FORAGE HARVESTERS

Replacement parts produced by Kooima® Company to fit JD® 7000 Series

KOOIMA #	DESCRIPTION	REPLACES OEM #
K56626 \$70.45 ea.	⑪ • Sharpening stone • To fit all 7200-7580 series harvesters • 3 lbs. • Bolt kit: K56626BK , \$2.75 ea. .10 lbs.	AZ56626
K49623 \$8.75 ea.	⑫ • Top strap • To fit all 7200-7580 series harvesters • 48 required • 1 lb.	Z49623/Z60535 Heat Treated
K70982 \$11.50 ea.	⑬ • Angle bracket • Weld-on • 3.1 lbs. • To fit all 7200-7500 series harvesters • Old style straight knife bracket	Z101528 Z70982
K71196 \$7.75 ea.	⑭ • Bottom nut • .9 lbs. • Used with angled knife brackets • To fit all 7200-7580 series harvesters • 48 required	Z71196/Z49625
K69650 \$2.15 ea.	⑮ • Knife bolt • Grade 10.9 metric • .2 lbs. • 144 required • To fit all 7200-7580 series harvesters	Z69650/Z61067
K12816 \$550.80 ea.	⑯ • RH bearing housing • 28 lbs. • To fit all 7000 series harvesters up to SN 510523 • Bolt kit: K12816BK , \$17.80 ea., 3.5 lbs.	Z12816
K48939 \$415.80 ea.	⑰ • RH spherical bearing • 6.3 lbs. • To fit all 7000 series harvesters up to SN 510523 • Will need to get K39504 seal, \$19.30 ea. Replaces OEM # AZ39504	AZ48939
K12815 \$430.80 ea.	⑱ • LH bearing housing • 15.5 lbs. • To fit all 7000 series harvesters up to SN 510523 • Bolt kit: K12815BK , \$13.30 ea., 2.5 lbs.	Z12815
K9307 \$157.75 ea.	⑲ • LH bearing • Fits shaft with 2.94" OD • To fit all 7000 series harvesters up to SN 510523 • 6.3 lbs.	JD9307
K9308 \$20.80 ea.	⑳ • LH locking collar • To fit all 7000 series harvesters up to SN 510523 • 1.3 lbs.	JD9308
K71139 \$163.25 ea.	㉑ • 28 tooth sprocket • 6.15 lbs. • Fits all 7000 series machines with Electromagnetic clutch (STROMAG)	AZ71139
K63229 \$42.85 ea.	㉒ • 28 link chain • 3.83 lbs. • Also need K60LINK • Fits all 7000 series machines with Electromagnetic clutch (STROMAG)	AZ63229
K59516 \$65.45 ea.	㉒a • 42 pitch chain • 5.1 lbs. • Also need K60LINK • To fit all 7000 series harvesters	AZ59516
K60LINK \$4.25 ea.	㉒b • 60 chain link • .1 lbs. • Fits all 7000 series machines with Electromagnetic clutch (STROMAG)	
K101305 \$105.75 ea.	㉓ • Electromagnetic Clutch Plate (STROMAG) • 1.25 lbs. • To fit harvesters 6610-7550 • 2 required • Made from high wear spring steel • Bolt kit: K101305BK , \$4.05 ea. .25 lbs.	AZ101305 Heat Treated
FH5001045 \$1,100.00 ea.	• Replacement cutter drum shaft • 134 lbs. • To fit Kooima® drums only 	

K63686 \$300.80 ea.		• LOC gear box shaft • To fit JD® 6610-6910 serial #002776 & above and 7200-7550 harvesters	Z63686
-------------------------------	---	--	--------

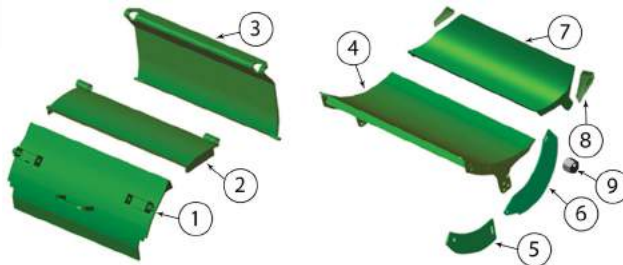

KOOIMA #	DESCRIPTION	REPLACES OEM #
K54310 \$74.00 ea.	① • Cutterhead door • To fit 7200-7580 series harvesters • 28.2 lbs.	AZ54310 Abrasion Resistant
K54323 \$63.00 ea.	② • Cutterhead door • To fit 7200-7580 series harvesters • 18.8 lbs.	AZ54323 Abrasion Resistant
K57245 \$165.75 ea.	③ • Cutterhead shield • To fit 7200-7580 series harvesters • 43.5 lbs.	AZ57245 Abrasion Resistant
K62425 \$175.75 ea.	④ • Spiral floor plate • To fit 7200-7500 series harvesters • 47.5 lbs.	AZ62425 Abrasion Resistant
K72502 \$9.00 ea.	⑤ • Cutterhead wear plate • 2 required • 2.3 lbs. • To fit all 7200-7580 series harvesters • Bolt Kit: K48655BK - 1 kit/plate \$3.25 ea., .1 lbs. Abrasion Resistant	Z72502 Abrasion Resistant
K75383 \$23.30 ea.	⑥ • Cutterhead bracket • 2 required • To fit all 7200-7580 series harvesters • 8 lbs.	Z75383 Abrasion Resistant
K103655 \$190.75 ea.	⑦ • Spiral floor plate • To fit all 7200-7580 series harvesters • 41.4 lbs.	AXE40436/AZ103655 Abrasion Resistant
K103389 \$65.45 ea.	⑧ • Spiral floor deflector • 2 required • To fit all 7200-7580 series harvesters • 3.7 lbs.	Z103389 Abrasion Resistant
K103389BK \$2.15 ea.	⑧a • Bolt for deflector • 2 required per deflector • To fit all 7200-7580 series harvesters • .05 lbs.	19M7783
K64299C \$12.25 ea.	⑨ • Cutterhead bracket adjusting cam • To fit 7200-7500 series harvesters • 2 required • .45 lbs.	E64299

Order online at WWW.KOOIMA.COM and receive **FREE FREIGHT** to your door!

KOOIMA® REPLACEMENT PARTS TO FIT 7200-7500 SERIES JOHN DEERE® FORAGE HARVESTERS

Replacement parts produced by Kooima® Company to fit JD® 7000 Series

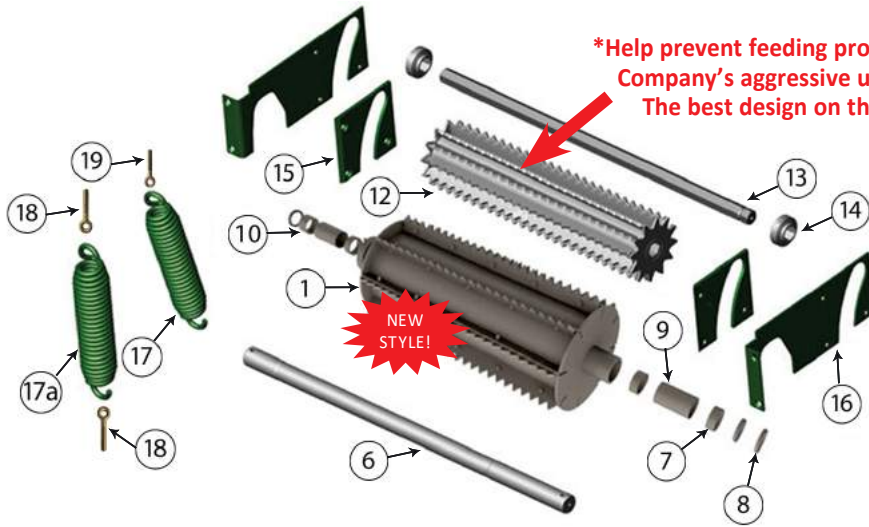

KOOIMA #	DESCRIPTION	REPLACES OEM #
K50611SP \$1,510.00 ea.	1 • Special upper front feed roll, great for corn & cane! • To fit all 7200-7580 series • Heavy Duty 4 Large Bearing Design! • Complete with bolt-on teeth and bearings • 91 lbs. w/o teeth	AZ101035/AZ50611 AZ58228/AZ102095/AZ101103 Stainless Steel Stainless Steel
K50611SPT \$57.35 ea.	2 • Bolt-on tooth • To fit #K50611SP roll • To fit all 7200-7580 series harvesters equipped with Kooima® upper front feed rolls • 8 required • 22 lbs./8 pc. set	Stainless Steel
K50611SPFT \$49.35 ea.	3 • Flat replaceable crossbar • To fit #K50611SP feed roll • Eliminates wrapping in haylage • 3 lbs. ea.	Stainless Steel
K50611SPTBK \$57.35 ea.	4 • Hardware kit for K50611, K50611SPT, & K50611SPFT • 2.5 lbs.	
K73857 \$52.35 ea.	5 • Bolt-on tooth • 8 required • 2.25 lbs. • To fit all 7200-7580 series equipped with factory upper front feed roll	E73857/HXE64649 Stainless Steel
K73857BK \$57.35 ea.	5a • Hardware kit for K73857 • 3 lbs.	
K81671 \$340.80 ea.	6 • Upper front feed roll shaft • To fit John Deere® harvesters with the new larger 4-bearing system • 26.5 lbs.	Z81671 Heat Treated
K10071 \$16.80 ea.	7 • Upper front feed roll bearing - larger diameter style • 3 required • .2 lbs.	JD10071
K28870 \$12.75 ea.	8 • Upper front feed roll seal • 3 required • .1 lbs.	AL28870
K101917 \$21.80 ea.	9 • Upper front feed roll bushing • Used with larger diameter bearing system • .6 lbs.	Z101917
K62417 \$19.30 ea.	10 • Upper front feed roll bearing - larger diameter style • Used with larger diameter bearing system • 1 required • .35 lbs.	AZ62417
K10108 \$9.25 ea.	11 • Needle bearing • Original smaller bearing style • .2 lbs. • Use with K50611SP feed rolls with 2" diameter bearing system	JD10108
K48677 \$650.00 ea.	12 • Upper rear feed roll • To fit all 7200-7580 series harvesters • Reversible aggressive design • 68 lbs.	AZ48677/AZ51787 Stainless Steel
K71834 \$630.80 ea.	12a • Upper rear feed roll • Reversible aggressive design • This feed roll is made with AR material • 68 lbs.	AZ71834 Abrasion Resistant
K63862 \$140.75 ea.	13 • Upper rear feed roll shaft • To fit all 7200-7580 series • 38-3/16" x 32mm hex shaft • 16 lbs.	Z63862/Z81670/HXE26048 Heat Treated
K10458 \$40.35 ea.	14 • Upper rear feed roll bearing • 2 required • To fit all 7200-7580 series harvesters • 1 lb.	JD10458
K61010 (Left) K61011 (Right) \$26.55 ea.	15 • Wear plate, feed roll frame • To fit all 7200-7580 series harvesters • 1 each required • 2.8 lbs. ea.	Z61010 Z61011 Heat Treated
K61010BK \$9.25 ea.	15a • Hardware kit to fit K61009(LH) & K61008(RH) • Also bolts up to K61010(LH) & K61011(RH) • 1 bolt kit required per wear plate • .2 lbs.	
K61009 (Left) K61008 (Right) \$20.30 ea.	16 • Feed roll wear plate retainer • To fit all 7200-7580 series harvesters • 1 each required • 4.8 lbs. ea.	Z61009 Z61008 Abrasion Resistant
K64796 \$63.45 ea.	17 • Rear feed roll lift arm spring • Use as required • To fit all 7200-7580 series harvesters • 12 lbs.	Z67236 / E64796
K75927 \$47.85 ea.	17a • Front spring for the double spring assembly • To fit all 7200-7580 series harvesters • 6.4 lbs.	Z75927
K76429 \$24.30 ea.	18 • Front spring eye bolt • Includes 2 nuts • To fit 6000-7000 series harvesters • .6 lbs.	Z76429 14M7276
K103433 \$35.85	19 • Rear spring eye bolt • Includes 2 nuts • To fit 6000-7000 harvesters • 1.37 lbs.	Z103433/Z62088 14M7306

FREE FREIGHT ON RETAIL ORDERS OVER \$750.00!

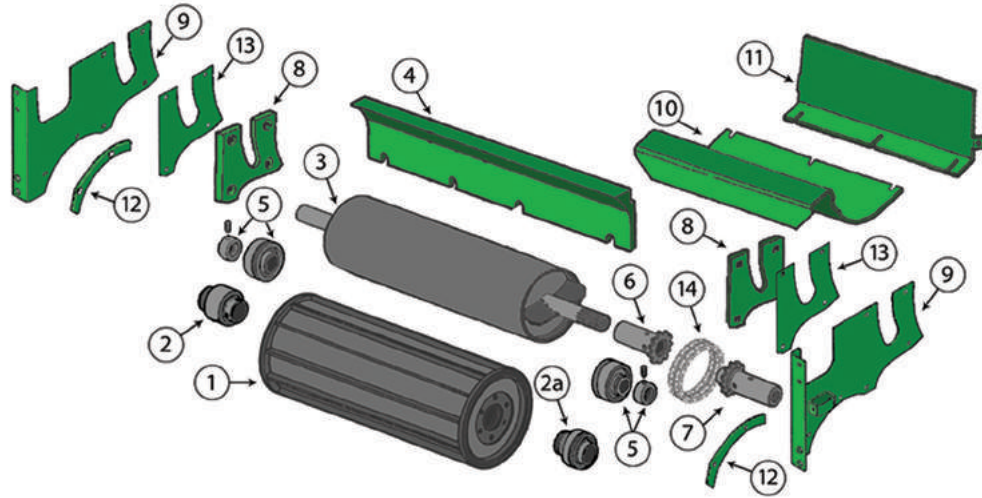

KOOIMA #	DESCRIPTION	REPLACES OEM #
K50090 \$1,080.00 ea.	① • Feed roll, lower front • To fit all 7200-7580 series harvesters • 56.4 lbs.	AZ50090/AZ101149 Stainless Steel
K51405 \$53.35 ea.	② • Right hand bearing • Lower front feed roll • 1 required • To fit all 7200-7580 series harvesters • 1.4 lbs.	AZ51405
K47864 \$47.35 ea.	②a • Left hand bearing • Lower front feed roll • 1 required • To fit all 7200-7580 series harvesters • 1.5 lbs.	AZ47864/AXE10405
K58444 \$515.80 ea.	③ • Lower rear smooth roll • To fit all 7200-7580 series harvesters • Now made of heat treated carbon steel for better wear resistance • 52 lbs.	AZ103271/AZ58444 Heat Treated
K12818 \$195.75 ea.	④ • Smooth roll cleaner, 5 3/8" tall • 18.7 lbs. • To fit 7200-7580 series harvesters • Bolt kit: K12818BK, \$4.50 ea.	Z13356 Z12818
K10445 \$52.35 ea.	⑤ • Smooth roll bearing • 1.2 lbs. • To fit all 7200-7580 series harvesters • 2 required	JD10445
K51114 \$89.95 ea.	⑥ • Inside smooth roll drive coupler • To fit all 7200-7580 series harvesters • 2.5 lbs.	AZ51114
K51115 \$91.95 ea.	⑦ • Outside smooth roll drive coupler • To fit all 7200-7580 series harvesters • 3.4 lbs.	AZ51115
K68062 (Left) K68063 (Right) \$69.45 ea.	⑧ • Feed roll wear plate • To fit 7200-7580 series harvesters • 1 each required • 4 lbs. ea.	Z68062 Z68063 Tungsten Carbide
K100685 (LH) K100686 (RH) \$75.45 ea.	⑨ • Feed roll wear plate • To fit 7200-7500 series harvesters up to SN. 508669 • 1 each required • 8.9 lbs. ea.	AZ100685 AZ100686 Abrasion Resistant
K101960 (LH) K101961 (RH) \$140.75 ea.	⑨a • Feed roll wear plate • To fit 7200-7580 series harvesters after SN. 508669 • 1 each required • 8.3 lbs. ea.	AZ101960 AZ101961 Abrasion Resistant
K101960BK \$17.05 ea.	⑨b • Feed roll wear plate bolt kit • 1 kit required per side • .7 lbs.	
K63659 \$70.45 ea.	⑩ • Lower feed roll pan • Front pan, used when grinding ear corn with recutter screen • To fit all 7200-7580 series harvesters • 28.2 lbs.	Z63659 Abrasion Resistant
K50086 \$80.45 ea.	⑪ • Lower feed roll pan • Rear pan, used when grinding ear corn with recutter screen • To fit all 7200-7580 series harvesters • 12.3 lbs.	AZ50086 Abrasion Resistant
K50086BK \$6.25 ea.	⑪a • Earlage pans bolt kit • To fit all series earlage pans • 1 kit required • .25 lbs.	
K102365 (LH) K102366 (RH) \$41.35 ea.	⑫ • Reinforcement • Used on K101960 and K101961 wear plates • To fit 7200-7580 series harvesters • 1 each required .85 lbs.	Z102365 Z102366 Abrasion Resistant
K68083 \$18.80 ea.	⑬ • Reinforcement • To fit all 7200-7580 series harvesters • 1 lb.	Z68083
K47886 \$55.35 ea.	⑭ • 14 link chain • To fit all 7200-7500 series harvesters • 1 lb.	AZ47886
K47886BK \$3.25 ea.	⑮ • Bolt kit for K47886 • .1 lbs. • To fit all 7200-7500 series harvesters	

K62425CP



\$935.80 ea.

- Cracker plate
- To fit 7200-7500 series harvesters
- Cracks 85-90% of kernels with minimal power requirements
- Bolt-in installation, no moving parts to maintain
- Use in whole plant corn silage or to grind earlage
- Patent #6,234,072 & #6,327,970 • 56 lbs.

Abrasion Resistant Tungsten Carbide

TO ORDER CALL TOLL FREE 1-800-522-8874



KOOIMA® REPLACEMENT PARTS TO FIT 7200-7500 SERIES JOHN DEERE® FORAGE HARVESTERS

Replacement parts produced by Kooima® Company to fit JD® 7000 Series

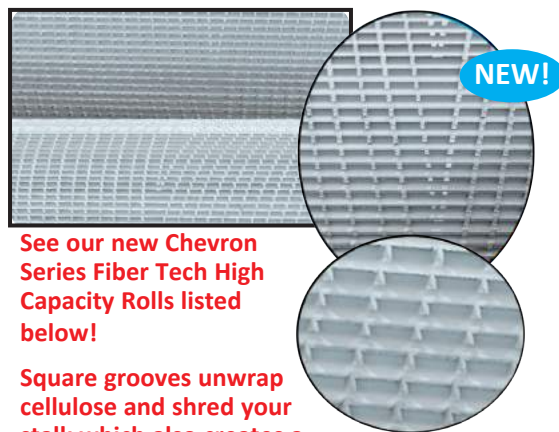
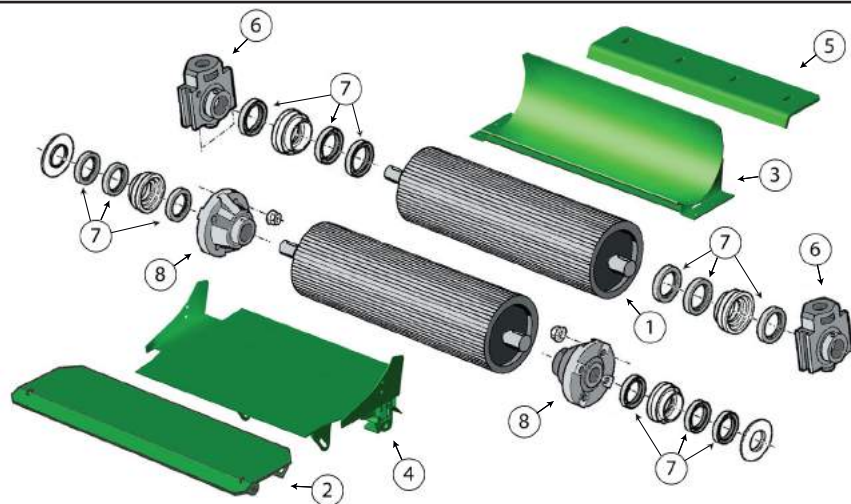

See our new Chevron Series Fiber Tech High Capacity Rolls listed below!

Square grooves unwrap cellulose and shred your stalk which also creates a far superior process job.

KOOIMA #	DESCRIPTION	REPLACES OEM #
K53319 \$1,190.00 ea.	1 • Kernel processor roll • Saw tooth design • Now compatible with JD® Labyrinth seal system • To fit all 7200-7580 series harvesters • 2 required • 152.5 lbs.	AZ53319/AZ101800 Heat Treated
K53319DC \$1,295.00 ea.	1a • Kernel processor roll • 152 lbs. • Get the real value out of your processor with the new Dual Cut High Capacity Rolls • To fit all 7200-7580 series harvesters • 2 required	AZ53319/AZ101800 Heat Treated
K53319HPF (Fast, Top 106 tooth) K53319HPS (Slow, Bottom 120 tooth) \$1,675.00 ea.	1b • Kernel processor roll • 153 lbs. • Get the real value out of your processor with the new Chevron Series Fiber Tech High Capacity Rolls • To fit all 7200-7580 series harvesters • 2 required	AZ53319 Heat Treated Chromed Plated Roll
K48919 \$83.45 ea.	2 • Kernel processor deflector • To fit all 7200-7580 series harvesters • 17.6 lbs.	AZ48919 Abrasion Resistant
K55165 \$150.75 ea.	3 • Rear cover • To fit all 7200-7580 series harvesters equipped with kernel processor • 35.6 lbs.	AZ55165 Abrasion Resistant
K71588 \$290.75 ea.	4 • Bottom cover • To fit all 7200-7580 series harvesters • 38.5 lbs.	AZ71588 Abrasion Resistant
K73234 \$51.10 ea.	5 • Kernel processor deflector • 11 lbs. • To fit all 7200-7580 series harvesters • Hardware Kit: K73234BK - \$5.75 ea., .3 lbs.	Z73234 Abrasion Resistant
K100856 \$240.75 ea.	6 • Bearing with housing for upper kernel processor rolls • 9 lbs. • To fit all 7200-7500 series up to SN. 508668 • 2 required	AZ100856
K101706 \$245.75 ea.	6 • Bearing with housing for upper kernel processor rolls • 8 lbs. • To fit all 7200-7580 series after SN. 508669 • 2 required	AZ101706
K102198 \$7.40 ea.	7 • Seal • 6 required per roll • To fit all 7200-7580 series after SN. 508669 • .05 lbs.	AZ102198
K100857 \$240.75 ea.	8 • Bearing with housing for lower kernel processor rolls • To fit all 7200-7500 series up to SN. 508668 • 2 required • 8.5 lbs.	AZ100857
K102483 \$265.75 ea.	8 • Bearing with housing for lower kernel processor rolls • 9 lbs. • To fit all 7200-7580 series after SN. 508669 • 2 required	AZ102483

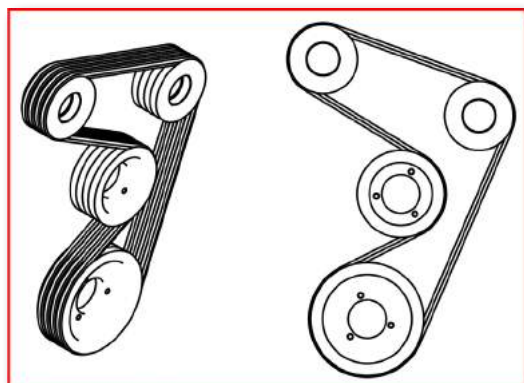

Improved 4 belt processor belt update kit!

- 15% more power transmission
- 4 A belts proven to run cooler than traditional 3 B-belt setup
- Belts will last longer and run cooler while providing more power
- Comes complete with belts, pulleys, idler pulley bearings, caps and seals
- Also comes with beveled scraper to minimize crop buildup on bottom roll

K7000PAN
\$1,302.00 ea.

- 4 Belt processor belt update kit
- **To fit John Deere® 7200-7500 series narrow body harvesters**
- **Will also fit all 6000 series with minor modifications**

KAA78K
\$199.00 ea.

- 4 groove belt set
- To fit K7000PAW and K7000PAN processor update kit

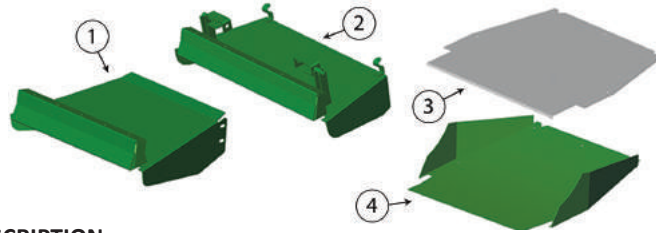

KOOIMA #	DESCRIPTION	REPLACES OEM #
K71742 \$75.45 ea.	① • Grass chute top • 28 lbs. • Hardware Kit: K57887BK - \$5.75 ea., .25 lbs. • To fit 7200-7580 series harvesters without kernel processors	Z71742 Abrasion Resistant
K57329 \$179.75 ea.	② • Grass chute top • 30.2 lbs. • To fit 7200-7580 series harvesters with kernel processors	AZ57329 Abrasion Resistant
K78611 \$165.75 ea.	③ • Stainless steel liner • 22 lbs. • To fit 7200-7580 series harvesters	Z78611 Stainless Steel
K78611BK \$3.25 ea.	③a • Stainless steel liner Bolt Kit • One kit required • Use with stainless steel liner #K78611 • .5 lbs.	
K63927 \$180.75 ea.	④ • 1-piece grass chute • Use with liner #K78611 • To fit all 7200-7580 series harvesters • 39 lbs.	AZ63927/AZ65662 Abrasion Resistant

Koyma Klad® Silage Plus Processor

This processor offers a new and more efficient way to process your silage, saving fuel and gaining capacity. Here at Kooima®, we've been making knives and shearbars for over 20 years. That same extended life coated technology is applied to the teeth in this disc processor. We haven't seen any measurable wear on processors with over 190,000 tons of silage run through the disc.

Conventional processing just isn't good enough anymore!
To fit standard body 7200-7580 series harvesters.

\$19,500.⁰⁰

Order # SC3005 Patent: 9833785, Others Pending

Customer Testimonial

"The Kooima klad did a great job processing kernels in our corn silage. We could not find any whole ones at 2 mm gap. It also did an excellent job with our ground ear corn. Our cows are performing very well on last year's silage." - Aaron Maassen, Maassen Dairy



980 lbs.

Disc wear after 190,000 tons of silage

The Rock Stop'er Pro

FORAGE HARVESTER STONE DETECTION SYSTEM



JD® must have double spring kit installed.



- Fits most makes and models of SPFH and pull type harvesters.
- Patented Inertia sensor stops feed drive when rocks are detected.
- In cab sensitivity adjustment for varying crop conditions.
- Call 1-800-522-8874 for more details!



Extra Sensor Available!
Order # SENSOR
Only **\$750⁸⁰** ea.

Order # ROCK STOPER
Only **\$2,950⁰⁰** ea.



Designed and manufactured in Canada.

KOOIMA® REPLACEMENT PARTS TO FIT 7200-7500 SERIES JOHN DEERE® FORAGE HARVESTERS

Replacement parts produced by Kooima® Company to fit JD® 7000 Series

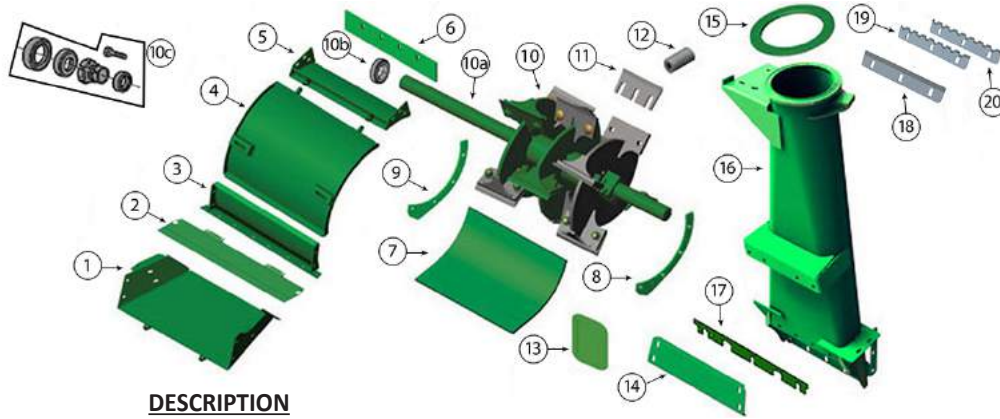

KOOIMA #	DESCRIPTION	REPLACES OEM #
K55555 \$130.75 ea.	① • Guide, rear feed channel • 18.2 lbs • To fit 7200-7580 series harvesters • K55555BK - Bolt Kit, \$8.75 ea., .35 lbs.	AZ55555 Abrasion Resistant
K102076 \$65.00 ea.	② • Feed guide top flap • To fit 7200-7580 series harvesters • 4.7 lbs.	AZ102076
K55604 \$49.35 ea.	③ • Front blower housing shield • 10 lbs. • To fit 7200-7580 series harvesters • K55604BK - Bolt Kit, \$4.55 ea., .25 lbs.	AZ55604 Abrasion Resistant
K46608 \$59.85 ea.	④ • Blower housing door • To fit all 7200-7580 series harvesters • 19.3 lbs.	AZ46608 Abrasion Resistant
K43828 \$49.85 ea.	⑤ • Top blower housing shield • 6.7 lbs. • To fit all 7200-7580 series harvesters • K43828BK - Bolt Kit, \$9.75 ea., .9 lbs.	AZ43828 Abrasion Resistant
K55782 \$15.05 ea.	⑥ • Blower housing cutoff strap • 6 lbs. • To fit all 7200-7580 series harvesters • K55782BK - Bolt Kit, \$8.25 ea. • .55 lbs	Z55782 Abrasion Resistant
K67028 \$79.45 ea.	⑦ • Bottom blower band • To fit 7200-7580 series harvesters • 21.5 lbs.	Z67028 Abrasion Resistant
K67030 \$20.00 ea.	⑧ • Left hand blower band support strap • 2.6 lbs. • 1 required • To fit all 7200-7580 series harvesters • K67030BK - Bolt Kit, \$14.80 ea., .4 lbs.	Z67030 Abrasion Resistant
K67031 \$20.00 ea.	⑨ • Right hand blower band support strap • 2.6 lbs. • 1 required • To fit all 7200-7580 series harvesters • K67030BK - Bolt Kit, \$14.80 ea.	Z67031 Abrasion Resistant
K51888 \$970.00 ea.	⑩ • Fan rotor assembly • To fit all 7200-7550 series harvesters with a 12 paddle blower • Includes fan rotor and shaft, 12 paddles and mounting hardware • 186.5 lbs.	AZ51888 AZ51887
K65324 \$300.80 ea.	⑩a • Blower shaft • To fit all 7200-7500 series harvesters with 12 paddle blower • 37.5 lbs.	Z65324
K10451 \$135.75 ea.	⑩b • Bearing • To fit all 7180-7580 series harvesters • 2 bearings needed per blower • 3.6 lbs	AXE10451
K10060 \$125.75 ea.	⑩c • Repair kit - includes 2 seals, 1 bearing cone, 1 ring and 1 cap screw • 2 kits needed per blower • 1.8 lbs	KXE10060
K72898 \$13.25 ea.	⑪ • Blower paddle • To fit all 7000 series harvesters • 7200-7550: 12 required • 1.2 lbs ea. • K72898BK - Bolt kit, \$60.00 ea., 7.4 lbs. Heat Treated/Tungsten Carbide/Abrasion Resistant	Z72898 E73207
K73207 \$240.75 ea.	⑫ • Spout worm gear • 1" bore all the way through • To fit all 7200-7500 series harvesters • 4.3 lbs.	Heat Treated Z20713
K20713 \$18.55 ea.	⑬ • Spout transition inspection door • 4.8 lbs. • To fit all 7000 series harvesters	Abrasion Resistant Z81903
K81903 \$20.05 ea.	⑭ • Spout transition side wall • 3 lbs. • To fit 7200-7580 series harvesters: 1 required • K60500BK - Bolt Kit, \$9.25 ea., .53 lbs.	Z67194
K67194 \$320.80 ea.	⑮ • Spout ring gear • To fit all 7000 series harvesters equipped with 250mm spout with standard spout turning device • 15.5 lbs	Tool Steel Z104829
K104829 \$425.80 ea.	⑮a • Spout ring gear • 16.3 lbs. • To fit 7250-7550 series harvesters equipped with improved spout turning device	Tool Steel HXE22859
K22859 \$400.80 ea.	⑮b • Spout ring gear • To fit 7180-7580 series harvesters • 15.5 lbs.	Tool Steel AZ104287/AZ71964
K71964 \$1,390.00 ea.	⑯ • Spout transition • 156.5 lbs. • To fit 7200-7500 series harvesters • K56941BK - Bolt kit, \$37.85 ea., 3.2 lbs.	Abrasion Resistant Z64393
K64393 \$10.00 ea.	⑰ • Adjusting strap • To fit 7000 series transition chutes • K64393BK - Bolt Kit, \$9.25 ea.	Z64393
K29868 \$19.55 ea.	⑱ • Blade • Koyma Klad® coating for better wear • 1.15 lbs. • To fit 7250-7580 series harvesters • 8 required	HXE29868
K34827 \$17.80 ea.	⑲ • Serrated blade • Koyma Klad® coating for better wear • To fit 7250-7580 series harvesters • 4 required • 1.1 lbs.	HXE34827
K34828 \$17.80 ea.	⑳ • Serrated blade • Koyma Klad® coating for better wear • To fit 7250-7580 series harvesters • 4 required • 1 lb.	HXE34828
KM12BK \$8.05 ea.	㉑ • Bolt kit • To fit K29868, K34827 & K34828 blades • 1 kit per blade required • .5 lbs.	03M7199 14M7401

FREE FREIGHT ON RETAIL ORDERS OVER \$750.00!

KOOIMA® REPLACEMENT PARTS TO FIT 7700-7980 SERIES JOHN DEERE® FORAGE HARVESTERS

John Deere® and JD® are registered trademarks of Deere & Company, which does not manufacture, distribute or endorse these parts.

Replacement parts produced by Kooima® Company to fit JD® 7000 Series

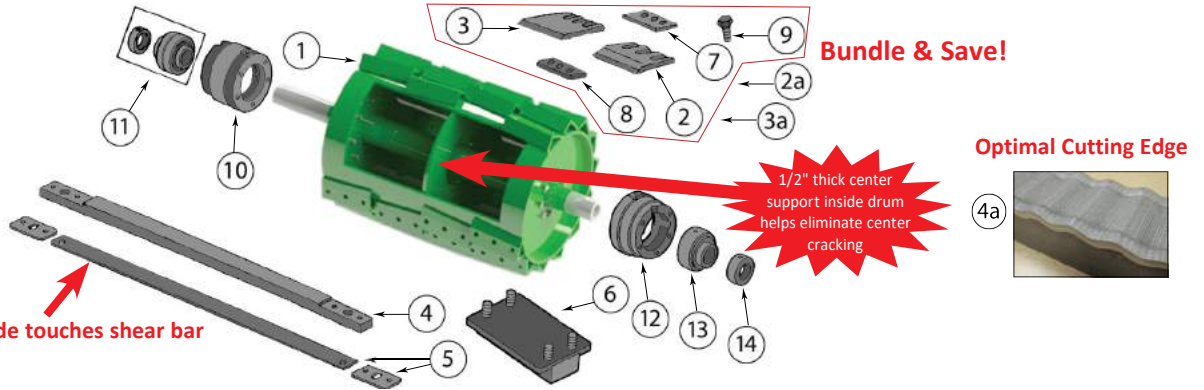
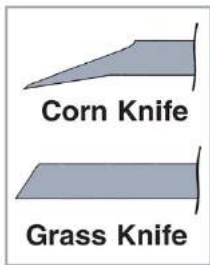

Bundle & Save!

Optimal Cutting Edge

1/2" thick center support inside drum helps eliminate center cracking

Gray side touches shear bar

KOOIMA #	DESCRIPTION	REPLACES OEM #
KAZ101205 \$4,600.00 ea. (1)	• 56 knife cutterhead drum • 706 lbs.	K103742 • 56 knife cutterhead drum
KAZ101206 \$4,375.00 ea. (1a)	• Tapered RH shaft • Up to serial # 510523	\$4,900.00 ea. • Serial # 510524 & after
KAZ101207 \$4,325.00 ea. (1b)	• 48 knife cutterhead drum • 671 lbs.	K103743 • 48 knife cutterhead drum
K72500 \$20.90 ea. (2)	• Tapered RH shaft • Up to serial # 510523	\$4,650.00 ea. • Serial # 510524 & after
K72500KIT \$42.80 ea. (2a)	• 40 knife cutterhead drum • 641 lbs.	K103744 • 40 knife cutterhead drum
K81123 \$19.90 ea. (3)	• Tapered RH shaft • Up to serial # 510523	\$4,400.00 ea. • Serial # 510524 & after
K81123KIT \$41.85 ea. (3a)	• Corn knife • To fit all 7700-7980 series harvesters	Z72500
K81123HP \$26.90 ea. (3b)	• 40, 48 or 56 required • 1.7 lbs.	Heat Treated/Tungsten Carbide
K64735HP \$890.00 ea. (4)	• Kit includes (1) K72500, (1) K76801, (1) K72498, (3) K69650	Z81123
K64735DSW \$1,275.00 ea. (4a)	• Save \$ when buying the kit! • 4.45 lbs.	Heat Treated/Tungsten Carbide
K64735HPBK \$19.80 ea. (4b)	• Grass knife • To fit all 7700-7980 series harvesters	Z81123
K724870 \$150.00 ea. (5)	• 40, 48 or 56 required • 1.9 lbs.	Heat Treated/Tungsten Carbide
K56626 \$70.45 ea. (6)	• Kit includes (1) K81123, (1) K76801, (1) K72498, (3) K69650	Z81123
K76801 \$8.60 ea. (7)	• Save \$ when buying the kit! • 4.65 lbs.	Heat Treated/Tungsten Carbide
K72498 \$9.10 ea. (8)	• Grass knife • Koyma Klad® coating • To fit 7700-7980 series harvesters	Z81123
K69650 \$2.15 ea. (9)	• Thicker tungsten carbide coating • Lasts longer than factory OEM Knives	Heat Treated/Tungsten Carbide
K12816 \$550.80 ea. (10)	• High performance shearbar • 48.4 lbs.	Z81123
K48939 \$415.80 ea. (11)	• To fit all 7700-7980 series harvesters	Heat Treated/Tungsten Carbide
K12815 \$430.80 ea. (12)	• Koyma Klad® hi-performance double sine wave shearbar • Patent # 8,109,176	Z81123
K9307 \$157.75 ea. (13)	• To fit 7700-7980 series harvesters • Maximize your shear bars cutting surface!	Heat Treated/Tungsten Carbide
K9308 \$20.80 ea. (14)	• Koyma Klad® coating maintains a long lasting sharp edge for more tons per hour • 47 lbs.	Heat Treated/Tungsten Carbide
FH5000949 \$1,300.00 ea. (14)	• Bolt Kit • 1.65 lbs.	Z81123
FH5001132 \$1,600.00 ea. (14)	• To fit K64735HP, K53906, K53906HP & K53905	Z81123
	• Shearbar wear strip kit • 1 kit required • 2 lbs	E72350/Z72486
	• Includes (2) #K72486 long wear strips & (2) #K72350 short wear strips	
	• To fit all 7700-7980 series harvesters • Gray side of wear strip always touches shear bar	
	• Sharpening stone	AZ56626
	• To fit all 7700-7980 series harvesters • 3 lbs. • Bolt kit: K56626BK , \$2.75 ea. .10 lbs.	
	• Top strap • To fit all 7700-7980 series harvesters	Z76801
	• 40, 48 or 56 required • 1.2 lbs.	Heat Treated
	• Bottom nut	Z72498/HXE29392
	• To fit all 7700-7980 series harvesters • 40, 48 or 56 required • .95 lbs.	
	• Knife bolt • Grade 10.9 metric • 144 required	Z69650/Z61067
	• To fit all 7700-7980 series harvesters • .2 lbs.	
	• RH bearing housing • 28 lbs.	Z12816
	• To fit all 7000 series harvesters up to SN 510523 • Bolt kit: K12816BK , \$17.80 ea., 3.5 lbs.	
	• RH spherical bearing • 6.3 lbs. • To fit all 7000 series harvesters up to SN 510523	AZ48939
	• Will need to get K39504 seal, \$19.30 ea. Replaces OEM # AZ39504	
	• LH bearing housing • 15.5 lbs.	Z12815
	• To fit all 7000 series harvesters up to SN 510523 • Bolt kit: K12815BK , \$13.30 ea., 2.5 lbs.	
	• LH bearing • Fits shaft with 2.94" OD	JD9307
	• To fit all 7000 series harvesters up to SN 510523 • 6.3 lbs.	
	• LH locking collar	JD9308
	• To fit all 7000 series harvesters up to SN 510523 • 1.3 lbs.	
	• Replacement cutter drum shaft • Up to SN # 510523	
	• To fit Kooima® drums only • 151 lbs.	
	• Replacement cutter drum shaft • SN 510524 & after	
	• To fit Kooima® drums only	



Podemos tomar órdenes en español! : 1-800-522-8874 • By fax: 712-476-6283 • Online: www.kooima.com



KOOIMA® REPLACEMENT PARTS TO FIT 7700-7980 SERIES JOHN DEERE® FORAGE HARVESTERS

Replacement parts produced by Kooima® Company to fit JD® 7000 Series

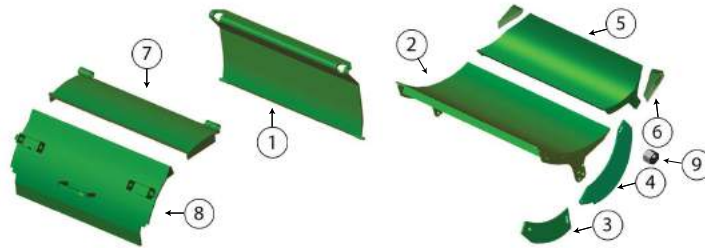

KOOIMA #	DESCRIPTION	REPLACES OEM #
K57552 \$160.75 ea.	① • Cutterhead shield • To fit 7700-7980 series harvesters • 51.3 lbs.	AZ57552 Abrasion Resistant
K58229 \$220.75 ea.	② • Spiral floor plate • To fit 7700-7980 series harvesters • 51.7 lbs.	AZ58229 Abrasion Resistant
K72502 \$9.00 ea.	③ • Cutterhead wear plate • 2 required • To fit all 7200-7980 series harvesters • 2.3 lbs.	Z72502 Abrasion Resistant
K75383 \$23.30 ea.	④ • Cutterhead bracket • 2 required • To fit all 7200-7980 series harvesters • 8 lbs.	Z75383 Abrasion Resistant
K103656 \$315.00 ea.	⑤ • Spiral floor plate - when using crop deflectors • To fit all 7700-7980 series harvesters • 47.6 lbs.	AXE40437 / AZ103656 Abrasion Resistant
K103389 \$65.45 ea.	⑥ • Spiral floor deflector • 2 required • To fit all 7200-7980 series harvesters • 3.7 lbs.	Z103389 Abrasion Resistant
K103389BK \$2.15 ea.	⑥a • Bolt for deflector • 2 required per deflector • To fit all 7200-7980 series harvesters • .05 lbs.	19M7783
K57836 \$220.75 ea.	⑦ • Cutterhead door • To fit 7700-7980 series harvesters • 20.25 lbs.	AZ57836 Abrasion Resistant
K58855 \$290.75 ea.	⑧ • Cutterhead door • 33.2 lbs. • To fit 7700-7980 series harvesters	AZ58855 Abrasion Resistant
K64299C \$12.25 ea.	⑨ • Cutterhead bracket adjusting cam • .45 lbs. • To fit 7700-7980 harvesters • 2 required	E64299

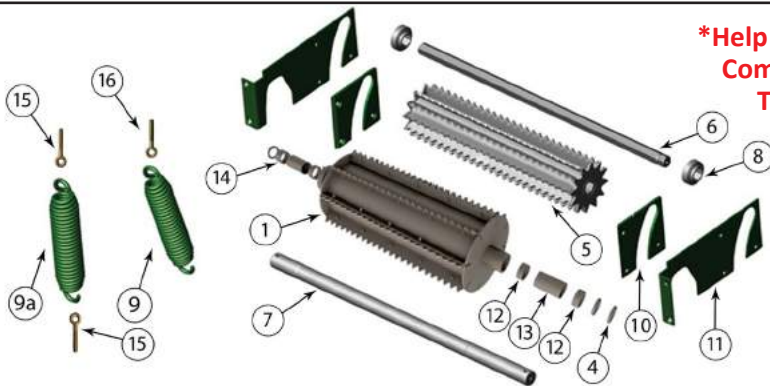

***Help prevent feeding problems with Kooima® Company's aggressive upper rear feed roll. The best design on the market today!**

KOOIMA #	DESCRIPTION	REPLACES OEM #
K103444 \$2,495.00 ea.	① • Upper front feed roll • To fit all 7700-7980 series harvesters • 110 lbs. • 4 heavy duty bearing design • Complete with bolt-on teeth & bearings	AZ103444 Stainless Steel
K79099 \$61.95 ea.	② • Flat replaceable crossbar • 8 required • 3.5 lbs. • To fit 7700-7980 upper front feed roll	HXE64653 / Z79099 Stainless Steel
K71583T \$74.00 ea.	③ • Bolt-on tooth • 8 required • To fit all 7700-7980 series harvesters • Hardware Kit: K71583TBK: \$80.45 ea. • 1 kit fits 8 teeth, 3.7 lbs.	Stainless Steel
K28870 \$12.75 ea.	④ • Upper front feed roll seal • 4 required • .1 lbs.	AL28870
K57147 \$915.00 ea.	⑤ • Upper rear feed roll • To fit all 7700-7980 series harvesters • Reversible aggressive design • 83 lbs.	AZ57147/AZ71837 Stainless Steel
K81669 \$180.75 ea.	⑥ • Upper rear feed roll shaft • To fit 7700-7950 series serial # 512027 and below • 42-7/8" x 32mm hex shaft • 20 lbs.	HXE26049 / Z81669 Heat Treated
K26049 \$185.75 ea.	⑥a • Upper rear feed roll shaft • To fit 7700-7950 series serial # 512028 and above • To fit all 7780-7980 series • 20 lbs.	HXE26049 Heat Treated
K81672 \$350.80 ea.	⑦ • Upper front feed roll shaft • To fit John Deere® harvesters with the new larger 4-bearing system • 29.5 lbs.	Z81672 Heat Treated
K10458 \$40.35 ea.	⑧ • Upper rear feed roll bearing • 2 required • To fit all 7700-7980 series harvesters • 1 lb.	JD10458
K64796 \$63.45 ea.	⑨ • Rear feed roll lift arm spring • Use as required • To fit all 7700-7980 series harvesters • 12 lbs.	Z67236 / E64796
K75927 \$47.85 ea.	⑨a • Front spring for the double spring assembly • To fit all 7700-7980 series harvesters • 6.4 lbs.	Z75927
K61010 (Left) K61011 (Right) \$26.55 ea.	⑩ • Wear plate, feed roll frame • 1 each required • To fit all 7700-7980 series harvesters • 2.8 lbs. ea. • Hardware Kit: K61010BK: \$9.25 ea. • 1 bolt kit required per wear plate, .2 lbs.	Z61010 Z61011 Heat Treated

TO ORDER BY FAX CALL 1-712-476-6283

KOOIMA® REPLACEMENT PARTS TO FIT 7700-7980 SERIES JOHN DEERE® FORAGE HARVESTERS

Replacement parts produced by Kooima® Company to fit JD® 7000 Series

KOOIMA #	DESCRIPTION	K61010BK \$9.25 ea.	REPLACES OEM #
K61009 (Left) \$20.30 ea.	• Feed roll wear plate retainer • To fit all 7700-7980 series harvesters • 1 each required • 4.8 lbs. ea.	• Hardware kit to fit K61009(LH) & K61008(RH) • Also bolts up K61010(LH) & K61011(RH) • 1 kit required per side • .2 lbs.	Z61009 Z61008 Abrasion Resistant
K10071 \$16.80 ea.	• Upper front feed roll bearing - larger diameter style • 3 required • .2 lbs.		JD10071
K101917 \$21.80 ea.	• Upper front feed roll bushing • Used with larger diameter bearing system • .6 lbs.		Z101917
K62417 \$19.30 ea.	• Upper front feed roll bearing - larger diameter style • Used with larger diameter bearing system • 1 required • .35 lbs.		AZ62417
K76429 \$24.30 ea.	• Front spring eye bolt • Includes 2 nuts • To fit 6000-7000 series harvesters • .6 lbs.		Z76429 14M7276
K103433 \$35.85	• Rear spring eye bolt • Includes 2 nuts • To fit 6000-7000 harvesters • 1.37 lbs.		Z103433/Z62088 14M7306

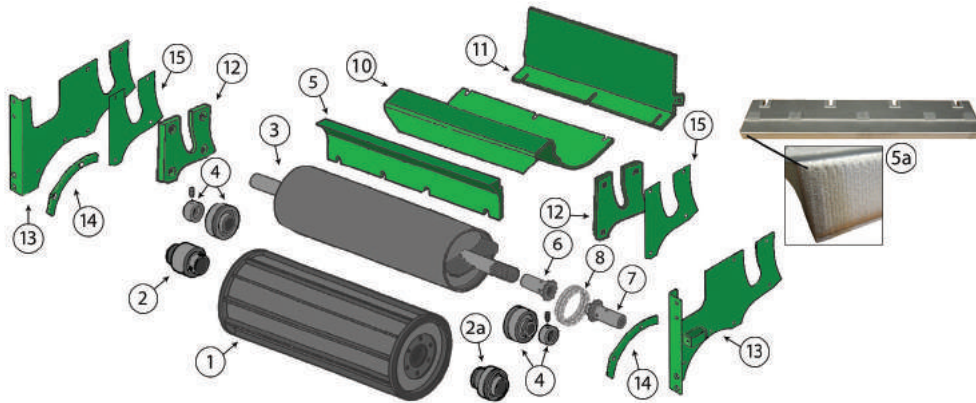

KOOIMA #	DESCRIPTION	REPLACES OEM #
K57158 \$1,720.00 ea.	• Feed roll, lower front • To fit all 7700-7980 series harvesters • 64.7 lbs.	AZ57158/AZ101150 Stainless Steel
K51405 \$53.35 ea.	• Right hand bearing • Lower front feed roll • 1 required • To fit all 7700-7980 series harvesters • 1.4 lbs.	AZ51405
K47864 \$47.35 ea.	• Left hand bearing • Lower front feed roll • 1 required • To fit all 7700-7980 series harvesters • 1.5 lbs.	AZ47864/AXE10405
K59687 \$630.00 ea.	• Lower rear smooth roll • To fit all 7700-7980 series harvesters • Now made of heat treated carbon steel for better wear resistance • 61.8 lbs.	AZ59687/AZ103272 Heat Treated
K10445 \$52.35 ea.	• Smooth roll bearing • 1.2 lbs. • To fit all 7700-7980 series harvesters • 2 required	JD10445
K105996 \$405.80 ea.	• Smooth roll cleaner • To fit 7700-7980 series harvesters • 19 lbs.	Z105996/Z13281
K105996HP \$725.80 ea.	• Koyma Klad® hi-performance smooth roll cleaner • Extended wear carbide coating! • To fit 7700-7980 series harvesters • 22.8 lbs.	Z105996/Z13281 Tungsten Carbide
K57514 \$190.75 ea.	• Inside smooth roll drive coupler • 2.5 lbs. • To fit all 7700-7980 series harvesters	AZ57514
K57354 \$195.75 ea.	• Outside smooth roll drive coupler • 3.4 lbs. • To fit all 7700-7980 series harvesters	AZ57354
K47886 \$55.35 ea.	• 14 link chain • 1 lb. • To fit all 7700-7980 series harvesters	AZ47886
K47886BK \$3.25 ea.	• Bolt kit for K47886 • .1 lb • To fit all 7700-7980 series harvesters	
K79268 \$210.75 ea.	• Lower feed roll pan • Front pan, used when grinding ear corn with recutter screen • To fit all 7700-7980 series harvesters • 34.8 lbs.	Z79268 Abrasion Resistant
K64453 \$160.75 ea.	• Lower feed roll pan • Rear pan, used when grinding ear corn with recutter screen • To fit all 7700-7980 series harvesters • 12.3 lbs.	AZ64453 Abrasion Resistant
K50086BK \$6.25 ea.	• Earlage pans bolt kit • To fit all series earlage pans • 1 kit required • .25 lbs.	
K68062 (Left) K68063 (Right) \$69.45 ea.	• Feed roll wear plate • To fit 7700-7980 series harvesters • 1 each required • 4 lbs. ea.	Z68062 Z68063 Tungsten Carbide
K100685 (LH) K100686 (RH) \$75.45 ea.	• Feed roll wear plate • To fit 7700-7980 series harvesters up to SN. 508669 • 1 each required • 8.9 lbs. ea.	AZ100685 AZ100686 Abrasion Resistant
K101960 (LH) K101961 (RH) \$140.75 ea.	• Feed roll wear plate • Used on K101960 and K101961 wear plates • To fit 7700-7980 series harvesters after SN. 508669 • 1 each required • 8.3 lbs. ea.	AZ101960 AZ101961 Abrasion Resistant
K101960BK \$17.05 ea.	• Feed roll wear plate bolt kit • 1 kit required per side • .7 lbs.	
K102365 (LH) K102366 (RH) \$41.35 ea.	• Reinforcement • To fit 7700-7980 series harvesters • 1 each required • .85 lbs.	Z102365 Z102366 Abrasion Resistant
K68083 \$18.80 ea.	• Reinforcement • To fit all 7700-7980 series harvesters • 1 lb.	Z68083

Order online at WWW.KOOIMA.COM and receive FREE FREIGHT to your door!

KOOIMA® REPLACEMENT PARTS TO FIT 7700-7980 SERIES JOHN DEERE® FORAGE HARVESTERS

Replacement parts produced by Kooima® Company to fit JD® 7000 Series

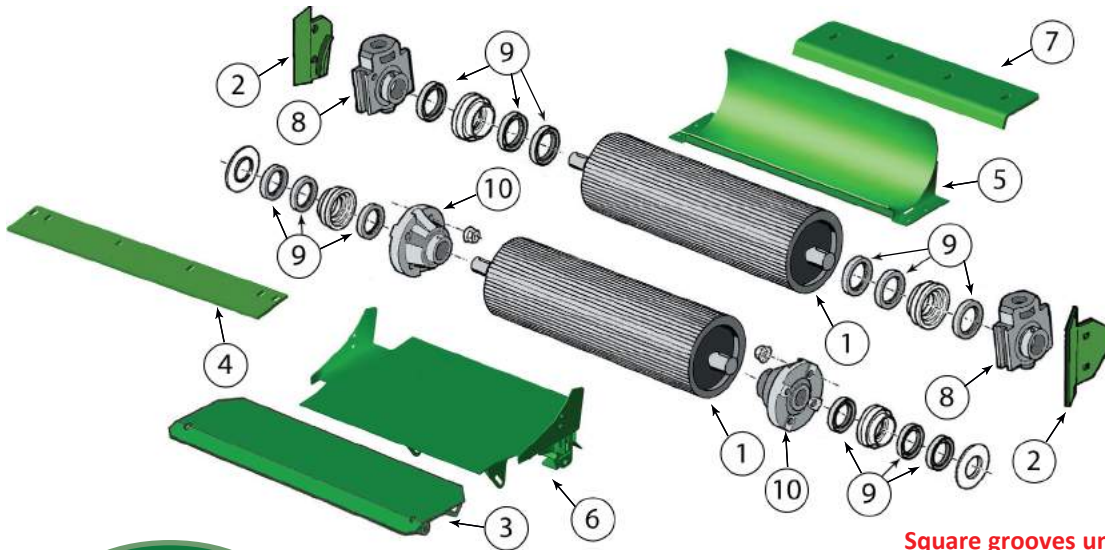

See our new Chevron Series Fiber Tech High Capacity Rolls listed below!

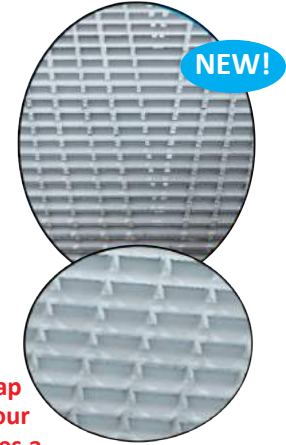

Square grooves unwrap cellulose and shred your stalk which also creates a far superior process job.

Now compatible with JD® Labyrinth seal system!

KOOIMA #	DESCRIPTION	REPLACES OEM #
K59157 \$1,350.00 ea.	• Kernel processor roll • Saw tooth design • To fit all 7700-7980 series harvesters • 2 required • 162.5 lbs.	AZ59157/AZ102602 Heat Treated
K59157DC (1a) \$1,550.00 ea.	• Kernel processor roll • Get the real value out of your processor with the new Dual Cut High Capacity Rolls • To fit all 7700-7980 series harvesters • 2 required • 177 lbs.	AZ59157/AZ102602 Heat Treated
K59157HPF (Fast, Top 118 tooth) K59157HPS (Slow, Bottom 130 tooth) (1b) \$1,950.00 ea.	• Kernel processor roll • 177 lbs. • Get the real value out of your processor with the new Chevron Series Fiber Tech High Capacity Rolls • To fit all 7700-7980 series wide body harvesters • 2 required	AZ59157/AZ102602 Heat Treated Chromed Plated Roll
K100687 (Left) K100688 (Right) \$32.35 ea.	• Kernel processor wear plate • 2.7 lbs. ea. • To fit all 7700-7980 series harvesters • K100687BK - Bolt kit, 1 kit/part, fits K100687 & K100688, \$4.50 ea., .15 lbs.	AZ100687/AXE11207 AZ100688 Abrasion Resistant
K63746 \$160.75 ea.	• Kernel processor deflector • To fit 7700-7980 series harvesters • 21.4 lbs.	AZ63746 Abrasion Resistant
K74716 \$30.35 ea.	• Kernel processor top deflector • To fit all 7700-7980 series harvesters • 9.1 lbs.	Z74716 Abrasion Resistant
K59235 \$180.75 ea.	• Rear cover • To fit all 7700-7980 series harvesters equipped with kernel processor • 41 lbs.	AZ59235 Abrasion Resistant
K71589 \$310.80 ea.	• Bottom cover • To fit all 7700-7980 series harvesters • 44 lbs.	AZ71589 Abrasion Resistant
K74717 \$35.35 ea.	• Kernel processor deflector • To fit all 7700-7980 series harvesters • 10.5 lbs.	Z74717 Abrasion Resistant
K100856 \$240.75 ea.	• Bearing with housing for upper kernel processor rolls • 9 lbs. • To fit all 7700-7980 series up to SN. 508668 • 2 required	AZ100856
K101706 \$245.75 ea.	• Bearing with housing for upper kernel processor rolls • 8 lbs. • To fit all 7700-7980 series after SN. 508669 • 2 required	AZ101706
K102198 \$7.40 ea.	• Seal • 6 required per roll • To fit all 7700-7980 series after SN. 508669 • .05 lbs.	AZ102198
K100857 \$240.75 ea.	• Bearing with housing for lower kernel processor rolls • To fit all 7700-7980 series up to SN. 508668 • 2 required • 8.5 lbs.	AZ100857
K102483 \$265.75 ea.	• Bearing with housing for lower kernel processor rolls • 9 lbs. • To fit all 7700-7980 series after SN. 508669 • 2 required	AZ102483

Truck icon signifies product is shipped via truck freight.

FREE FREIGHT ON RETAIL ORDERS OVER \$750.00!

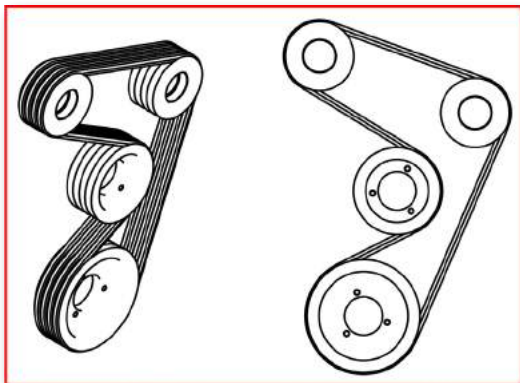

Improved 4 belt processor belt update kit!

- 15% more power transmission
- 4 A belts proven to run cooler than traditional 3 B-belt setup
- Belts will last longer and run cooler while providing more power
- Comes complete with belts, pulleys, idler pulley bearings, caps and seals
- Also comes with beveled scraper to minimize crop buildup on bottom roll

K7000PAW
\$1,100.00 ea.

- 4 Belt processor belt update kit
- To fit John Deere® 7700-7900 series wide body harvesters

KAA78K
\$199.00 ea.

- 4 groove belt set
- To fit K7000PAW and K7000PAN processor update kit

Koyma Klad® Silage Plus Processor

This processor offers a new and more efficient way to process your silage, saving fuel and gaining capacity. Here at Kooima®, we've been making knives and shearbars for over 20 years. That same extended life coated technology is applied to the teeth in this disc processor. We haven't seen any measurable wear on processors with over 190,000 tons of silage run through the disc. Conventional processing just isn't good enough anymore! To fit standard body 7700-7980 series harvesters.



1150 lbs.

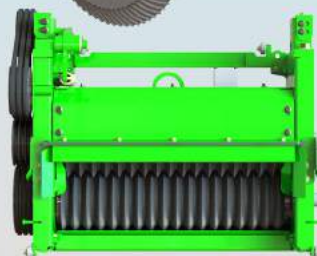

Disc wear after 190,000 tons of silage

\$21,500.⁰⁰

Order # SC3006 Patent: 9833785, Others Pending

Customer Testimonial

"We have used the Kooima processor for 3 years. It does a great job of processing with good chopper through put. Our nutritionist says it is some of the best processed corn silage he has sampled. The longevity of the rolls seem to be very good also." - Mark Sahr, Sahrside Dairy

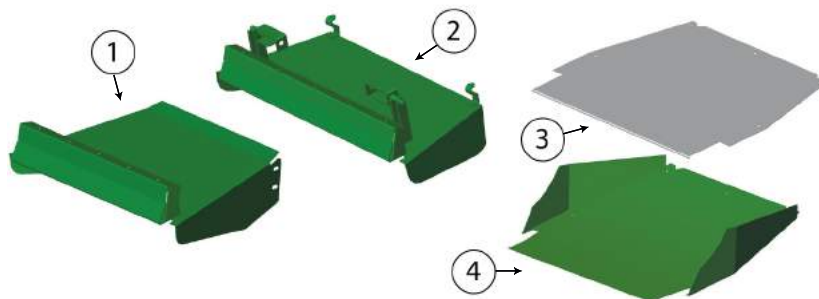

KOOIMA #
K74744
\$67.50 ea.
K61628
\$255.75 ea.
K78792
\$160.75 ea.
K78792BK
\$3.75 ea.
K65663
\$205.75 ea.

- ①
- ②
- ③
- ③a
- ④

DESCRIPTION

- Grass chute top • 32 lbs. • **K57887BK** - Bolt kit, \$5.75 ea., .25 lbs.
- To fit 7700-7980 series harvesters without kernel processors
- Grass chute top • 33.4 lbs. • **K61628BK** - Bolt kit, \$59.35 ea.
- To fit 7700-7980 series harvesters with kernel processors
- Stainless steel liner • 19 lbs.
- To fit 7700-7980 series harvesters
- Stainless steel liner Bolt Kit • One kit required
- Use with stainless steel liner #K78292 • .5 lbs.
- 1-piece grass chute • Use with liner #K78792
- To fit 7700-7980 series harvesters • 42.2 lbs.

REPLACES OEM #

- Z74744
- Abrasion Resistant**
AZ61628
- Abrasion Resistant**
Z78792
- Stainless Steel**
- AZ65663
- Abrasion Resistant**

TO ORDER CALL TOLL FREE 1-800-522-8874



KOOIMA® REPLACEMENT PARTS TO FIT 7700-7980 SERIES JOHN DEERE® FORAGE HARVESTERS

Replacement parts produced by Kooima® Company to fit JD® 7000 Series

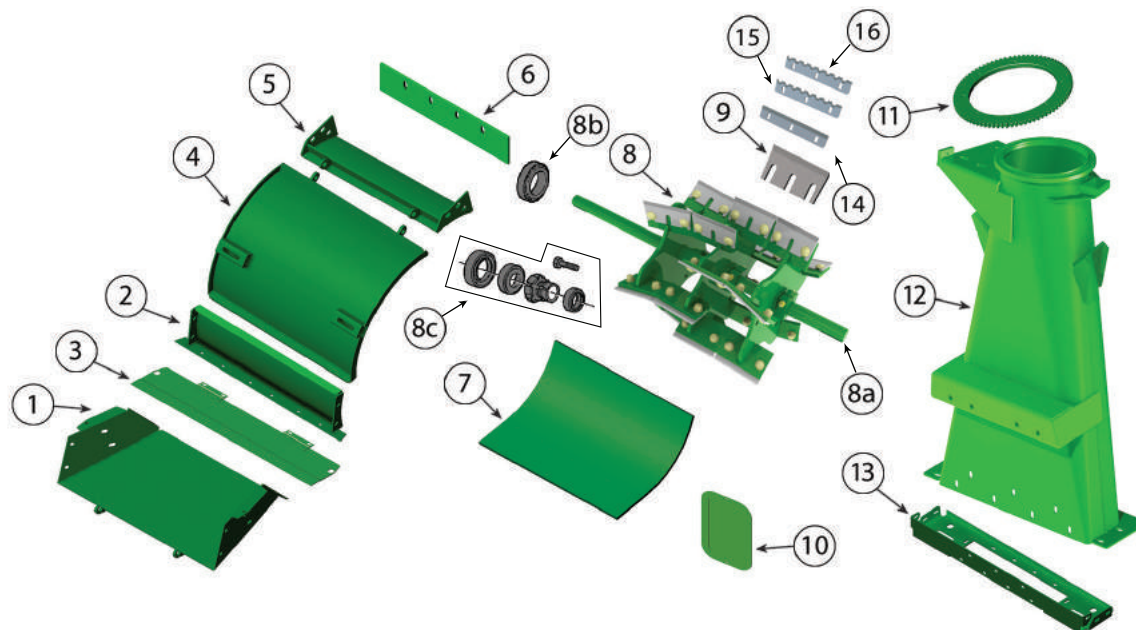

KOOIMA #	DESCRIPTION	REPLACES OEM #
K57887 \$120.75 ea.	① • Guide, rear feed channel • 18 lbs. • To fit 7700-7980 series harvesters • K57887BK - Bolt kit, \$5.75 ea., .25 lbs.	AZ57887 Abrasion Resistant
K57802 \$99.45 ea.	② • Front blower housing shield • 16 lbs. • To fit 7700-7980 series harvesters • K55604BK - Bolt kit, \$4.55 ea., .25 lbs.	AZ57802 Abrasion Resistant
K58161 \$37.35 ea.	③ • Feed guide top flap • To fit 7700-7980 series harvesters • 6.4 lbs.	AZ58161/AZ102077 Abrasion Resistant
K57801 \$180.75 ea.	④ • Blower housing door • To fit all 7700-7980 series harvesters • 22.7 lbs.	AZ57801 Abrasion Resistant
K57745 \$65.45 ea.	⑤ • Top blower housing shield • 7.6 lbs. • To fit all 7700-7980 series harvesters • K43828BK - Bolt kit, \$9.75 ea., .9lbs.	AZ57745 Abrasion Resistant
K73543 \$28.30 ea.	⑥ • Blower housing cutoff strap • 6.6 lbs. • To fit all 7700-7980 series harvesters • K73543BK - Bolt kit, \$11.50 ea., .65 lbs.	Z73543 Abrasion Resistant
K73473 \$160.75 ea.	⑦ • Bottom blower band • To fit 7700-7980 series harvesters • 36 lbs.	Z73473 Abrasion Resistant
KA257744 \$950.00 ea.	⑧ • Accelerator Rotor • To fit all 7700-7980 series with 20 paddle blower • Includes fan rotor and shaft, 20 paddles and mounting hardware • To fit SN. 511705 & below	AZ57744
KA257745 \$210.00 ea.	⑧a • Blower shaft • 41.4 lbs. • To fit wide body cutters SN. 511705 & below	Z73350
K10451 \$135.75 ea.	⑧b • Bearing • 2 bearings needed per blower • 3.6 lbs. • To fit SN. 511705 & below	AXE10451
K10060 \$125.75 ea.	⑧c • Repair Kit - includes 2 seals, 1 bearing cone, 1 ring and 1 cap screw • 2 kits needed per blower • 1.8 lbs. • To fit SN. 511705 & below	KXE10060
K72898 \$13.25 ea.	⑨ • Blower paddle • To fit all 7000 series harvesters • 7700-7980: 20 required • 1.2 lbs ea. Heat Treated/Tungsten Carbide/Abrasion Resistant	Z72898
K72898BK \$60.00 ea.	⑨a • Blower Paddle Bolt Kit • Use with K72898 blower paddles • 2 kits required • 7.4 lbs.	
K20713 \$18.55 ea.	⑩ • Spout transition inspection door • 4.8 lbs. • To fit all 7000 series harvesters	Z20713 Abrasion Resistant
K67194 \$320.80 ea.	⑪ • Spout ring gear • To fit all 7000 series harvesters equipped with 250mm spout with standard spout turning device • 15.5 lbs.	Z67194 Tool Steel
K104829 \$425.80 ea.	⑪a • Spout ring gear • To fit all 7750-7950 series up to SN. 511705 equipped with improved spout turning device • 16.3 lbs.	Z104829 Tool Steel
K22859 \$400.80 ea.	⑪b • Spout ring gear • 15.5 lbs. • To fit all 7750-7950 series after SN. 511706 • Fits all 7780-7980 series harvesters	HXE22859 Tool Steel
K58194 \$1,470.00 ea.	⑫ • Spout transition • Used with worm gear spout rotation system • To fit 7700-7980 series harvesters • To fit SN. 511705 & below • 164.5 lbs.	AZ58194/AZ104218 Abrasion Resistant
K82113 \$95.45 ea.	⑬ • Spout transition support • To fit 7700-7980 series harvesters • 30.05 lbs.	Z82113 Abrasion Resistant

KOOIMA #	DESCRIPTION	REPLACES OEM #
K29814 \$22.30 ea.	14 • Blower paddle • Koyma Klad® coating for extended wear • 1.4 lbs. • To fit 7750-7980 with SN. 511706 & up • 10 required	HXE29814 Tungsten Carbide/Heat Treated
K34825 \$15.30 ea.	15 • Serrated blade • Koyma Klad® coating for better wear • 1.3 lbs. • To fit 50 series wide body cutters with SN. 511706 & up • 5 required	HXE34825 Tungsten Carbide/Heat Treated
K34826 \$15.30 ea.	16 • Serrated blade • Koyma Klad® coating for better wear • 1.3 lbs. • To fit 50 series wide body cutters with SN. 511706 & up • 5 required	HXE34826 Tungsten Carbide/Heat Treated
KM12BK \$8.05 ea.	17 • Bolt kit • To fit K29814, K34825 & K34826 blades • 1 kit per blade required • .5 lbs.	03M7199 14M7401

HEADER DRIVE ADAPTERS

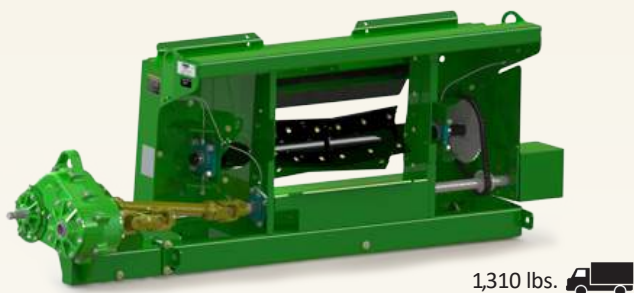

With the improved crop flow design and enclosed heavy duty gear box this is the most efficient header adapter on the market today. This adapter fits all 6000 & 7000 series harvesters. Patent # 8,376,126

Order # K00075 **\$12,500⁰⁰ ea.**

Eargle kit for the side walls of feed rolls. This kit will open up the feed rolls and prevent corn from exiting the sides. A real **MUST** when grinding eargle!

- Order # K7000KIT
- 7050 series machines only
 - To use on 7200-7500 series order # K101960BK also
 - 14.7 lbs.

\$450⁰⁰ ea.

- Longer rear spring eye bolt • Includes 2 nuts • 1.4 lbs.
- Needed when separating feed rolls for eargle
- Use with K7000KIT & K6000KIT

Order # K162269 **\$37⁰⁵ ea.**

Eargle Pans for Wide Throat Machines 7700-7850

K79268 - \$210.75

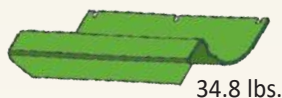

K64453 - \$160.75

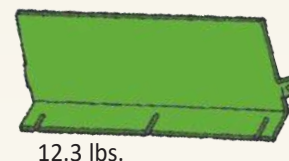

PTO Shafts

K21SP1250HEX • 1 1/4" hex to 1 3/8" 21 spline • 18.1 lbs.

K21SP1500HEX • 1 1/2" hex to 1 3/8" 21 spline • 17.6 lbs.

K21SP1125HEX • 1 1/8" hex to 1 3/8" 21 spline • 18.3 lbs.

\$490⁰⁰ ea.



K23TO23MALE • 1 1/2" 23 spline to 1 1/2" 23 spline
• Drive PTO, Replacement Drive Line
• 18.6 lbs.

\$490⁰⁰ ea.



Order # FH002943 • 1 1/2" 23 spline to 1 3/4" 20 spline shaft
• Replacement Drive Shaft • 4.85 lbs.

\$175⁰⁰ ea.



Belt for 2011 Models and Later

Order # 14-MGT-1568-125

\$875⁸⁰ ea.



Truck icon signifies product is shipped via truck freight.

Order online at WWW.KOOIMA.COM and receive **FREE FREIGHT** to your door!

KOOIMA® REPLACEMENT PARTS TO FIT 7000 SERIES JOHN DEERE® 250MM WIDE HI-ARCH SPOUT

Replacement parts produced by Kooima® Company to fit JD® 7000 Series

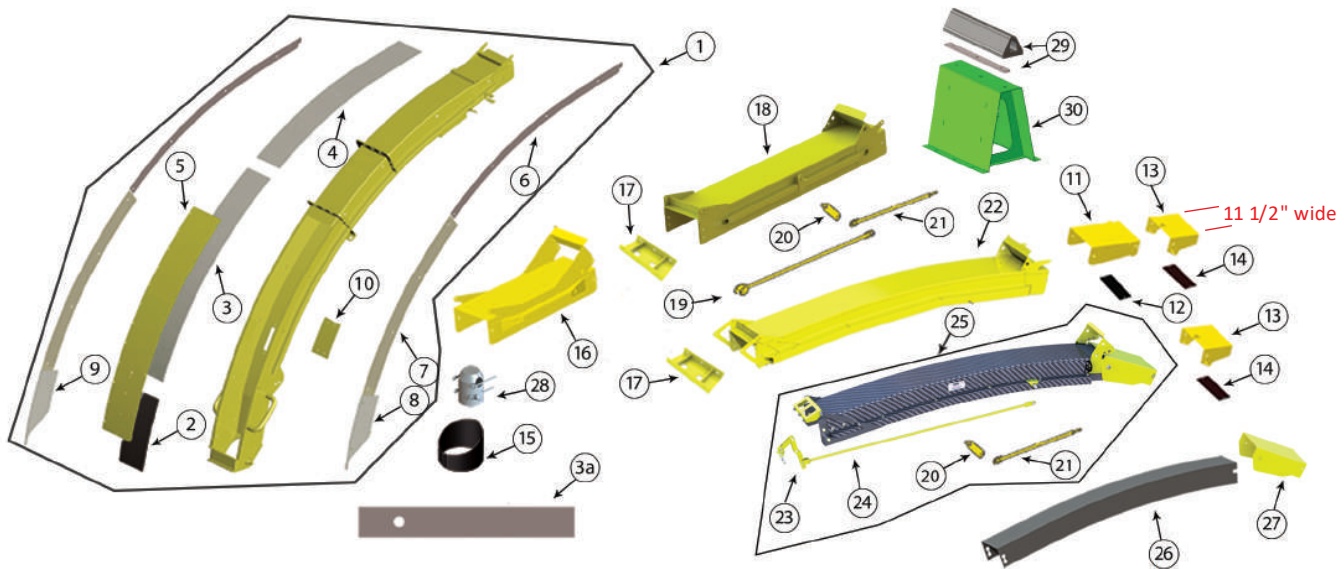

KOOIMA #	DESCRIPTION	REPLACES OEM #
K100830 \$3,100.00	1 • High arch spout • To fit 7000 series equipped with 250mm wide hi-arch spout • 475 lbs • SAVE \$200 when picked up at Kooima® Company!	AZ104282 Abrasion Resistant
K250mmBK \$20.30 ea.	1a • Spout liner bolt kit • When it's time to replace all the liners, order this bolt kit • 3.1 lbs.	
K53231 \$75.45 ea.	2 • Lower spout wear plate • SN. 510523 and before , 648mm long • To fit all 7000 series harvesters • Complete with mounting hardware • 13.8 lbs.	AZ53231 Abrasion Resistant
K53231EX \$105.75 ea.	2a • Extended spout wear plate • Reduces wear on the spout back and liners • To fit all 7000 series harvesters • Complete with mounting hardware • 19.5 lbs	AZ53231 Abrasion Resistant
K103510 \$120.75 ea.	2b • Lower spout wear plate • 848mm long • Complete with mounting hardware • To fit factory JD® spouts SN. 510524 and after • 24.2 lbs.	AZ103510 Abrasion Resistant
K53232 \$79.95 ea.	3 • Lower back spout liner • SN. 510523 and before , 2000mm long • To fit all 7000 series harvesters • 31.2 lbs. • Complete with mounting hardware	AZ53232 Abrasion Resistant
K101740 \$175.75 ea.	3a • Lower back spout liner • 32.3 lbs. • 2000mm long • Before SN. 510524 • To fit all 7000 series equipped with JD® moisture sensor • Complete with mounting hardware	AZ101740 Abrasion Resistant
K103381 \$120.75 ea.	3b • Lower back spout liner • 1800mm long • Complete with mounting hardware • To fit factory JD® spouts SN. 510524 and after • 28.2 lbs.	AZ103381 Abrasion Resistant
K54609 \$79.95 ea.	4 • Upper back spout liner • Complete with mounting hardware • To fit all 7000 series harvesters • 28.7 lbs.	AZ54609 Abrasion Resistant
K100829 \$105.75 ea.	5 • Bolt-on back liner • One required • 55.7 lbs. • To fit all harvesters equipped with Kooima® 250mm spout	Abrasion Resistant
K65656 \$125.00 ea.	6 • Upper side spout liner • Universal, to fit right or left • 4.6 lbs. • To fit all 7000 series harvesters • 2 required • Hardware Kit: KLINERBK , \$6.25, .3 lbs.	Z65656 Stainless Steel
K101661 \$125.75 ea.	6a • Upper side spout liner • To fit factory JD® spouts SN. 510524 and after • 5.8 lbs.	Z101661 Abrasion Resistant
K65657 \$125.00 ea.	7 • Lower side spout liner • Universal, to fit right or left • 6.8 lbs. • To fit all 7000 series harvesters • 2 required • Hardware Kit: KLINERBK , \$6.25, .3 lbs.	Z65657 Stainless Steel
K48903 \$48.35 ea.	8 • Left hand spout wear plate • To fit 7000 series harvesters • 9 lbs. • Hardware Kit: K48902BK , \$4.25, .09 lbs.	AZ48903 Abrasion Resistant
K48902 \$48.35 ea.	9 • Right hand spout wear plate • To fit 7000 series harvesters • 9 lbs. • Hardware Kit: K48902BK , \$4.25, .09 lbs.	AZ48902 Abrasion Resistant
K43921 \$33.85 ea.	10 • Access door • One required • 2.4 lbs. • To fit 7000 series harvesters with 250mm wide hi-arch spout	AZ43921
K54380 \$67.95 ea.	11 • Inner spout deflector • To fit all 7000 series harvesters • 14.6 lbs.	AZ54380 Abrasion Resistant
K54380BK \$11.25 ea.	11a • Inner spout deflector bolt kit • To fit #K54380 spout deflector • .35 lbs.	

KOOIMA® REPLACEMENT PARTS TO FIT 7000 SERIES JOHN DEERE® 250MM WIDE HI-ARCH SPOUT

Replacement parts produced by Kooima® Company to fit JD® 7000 Series

KOOIMA #	DESCRIPTION	REPLACES OEM #
K54381 \$29.30 ea.	(12) • Inner spout deflector wear plate • To fit #K54380 spout deflector • 5.8 lbs.	Abrasion Resistant
KBK \$3.25 ea.	(12a) • Wear plate bolt kit • .1 lbs. • To fit #K54381 spout deflector wear plate	
K53234 \$67.95 ea.	(13) • Outer spout deflector • To fit all 7000 series harvesters • 8 lbs.	AZ53234 Abrasion Resistant
K47896BK \$6.75 ea.	(13a) • Outer spout deflector bolt kit • To fit #K53234 spout deflector • .15 lbs.	
K53235 \$29.30 ea.	(14) • Outer spout deflector wear plate • To fit #K53234 spout deflector • 3.2 lbs.	Abrasion Resistant
KBK \$3.25 ea.	(14a) • Wear plate bolt kit • .1 lbs. • To fit #K53235 spout deflector wear plate	
K54264WL \$79.45 ea.	(15) • Weld-in transition liner • To fit all 7000 series harvesters • 8 lbs.	Abrasion Resistant
K54418 \$165.75 ea.	(16) • 36" spout extension • To fit all 7000 series harvesters • 39 lbs.	AZ104285/AZ54418/AZ59970 Abrasion Resistant
K54418BK \$9.25 ea.	(16a) • Spout extension bolt kit • To fit #K54418 & #K104288 spout extensions • 1.1 lbs.	
K104293 \$61.20 ea.	(17) • Spout stiffener bracket • Needed with 5' and 7' extensions • To fit all 7000 series harvesters • 4.1 lbs.	AZ104293
K104293BK \$32.85 ea.	(17a) • Bolt kit • To fit #K104293 bracket • 1 lb.	
K104288 \$615.80 ea.	(18) • 5' extension for a 250mm wide hi-arch spout • To fit all 7000 series harvesters • 67 lbs. • Uses K104291, K104292 & K104290 linkage pieces	AZ104288 AXE25112
K54418BK \$9.25 ea.	(18a) • Spout extension bolt kit • To fit #K104288 spout extension • .2 lbs.	
K104291 \$40.35 ea.	(19) • Replacement 5' extension link • To fit all 7000 series harvesters • 2.45 lbs.	AZ104291
K104292 \$30.35 ea.	(20) • Replacement lever for the 5' extension • To fit all 7000 series harvesters • .65 lbs.	AZ104292
K104292BK \$9.75 ea.	(20a) • Bolt kit • .2 lbs. • To fit #K104292 replacement lever	
K104290 \$35.35 ea.	(21) • Replacement 5' extension link • To fit all 7000 series harvesters • 1.65 lbs.	AZ104290
K7FTSP \$1,250.00 ea.	(22) • 7' steel extension for 250mm wide high arch spout • 97 lbs. • Uses FH5001062, FH5001059, K104292 & K104290 linkage pieces	
FH5001062 \$125.75 ea.	(23) • Replacement 7' extension actuator • Use with K7FTSP & K22416CF 7' extensions • To fit all 7000 series harvesters with 250mm wide high arch spout • 2.97 lbs.	
FH5001059 \$55.35 ea.	(24) • Replacement 7' extension link • Use with K7FTSP & K22416CF 7' extensions • To fit all 7000 series harvesters with 250mm wide high arch spout • 3.4 lbs.	
K22416CF \$2,750.00 ea.	(25) • Carbon fiber 7' spout extension • US PATENT 9,198,350 & 9,326,445 • Curved to optimize crop flow • Only 45 lbs. hardware included! • 1 piece liner • Light weight, abrasion resistant spout deflectors • Comes complete with inner deflector and linkage pieces • Do not install on worn or damaged spout base	AZ22416
FH5001046 \$260.00 ea.	(26) • Replacement carbon fiber spout extension center liner • High wear UHMW plastic • 14 lbs.	
FH5001069 \$65.45 ea.	(27) • Carbon fiber spout extension inner deflector • Optional steel version • 16 lbs.	
K250EXT \$80.45 ea.	(28) • 250mm spout cylinder extension • 4 lbs. • Gain up to 18" additional height on spout • Fill the back of the semi trailer when opening the field • A real must when using a 5' or longer extension!	
K69635 \$95.45 ea.	(29) • Spout rest support kit • 9.53 lbs. • Includes reinforcement bracket and mounting bolts • To fit all 250mm spout rests	Z69635 Z70507
K61312 \$90.45 ea.	(30) • 250mm spout rest base • 26.5 lbs. • To fit all 6000-7000 series with 250mm spouts • 1 required	AZ61312

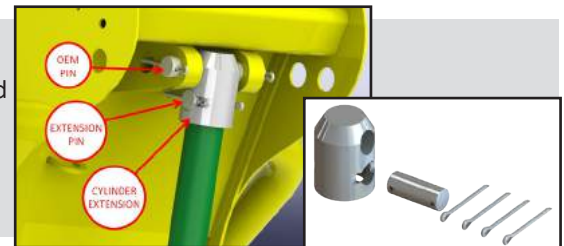

Order online at WWW.KOOIMA.COM and receive FREE FREIGHT to your door!

KOOIMA® REPLACEMENT PARTS TO FIT 7000 SERIES JOHN DEERE® 250MM WIDE LOW-ARCH SPOUT

Replacement parts produced by Kooima® Company to fit JD® 7000 Series

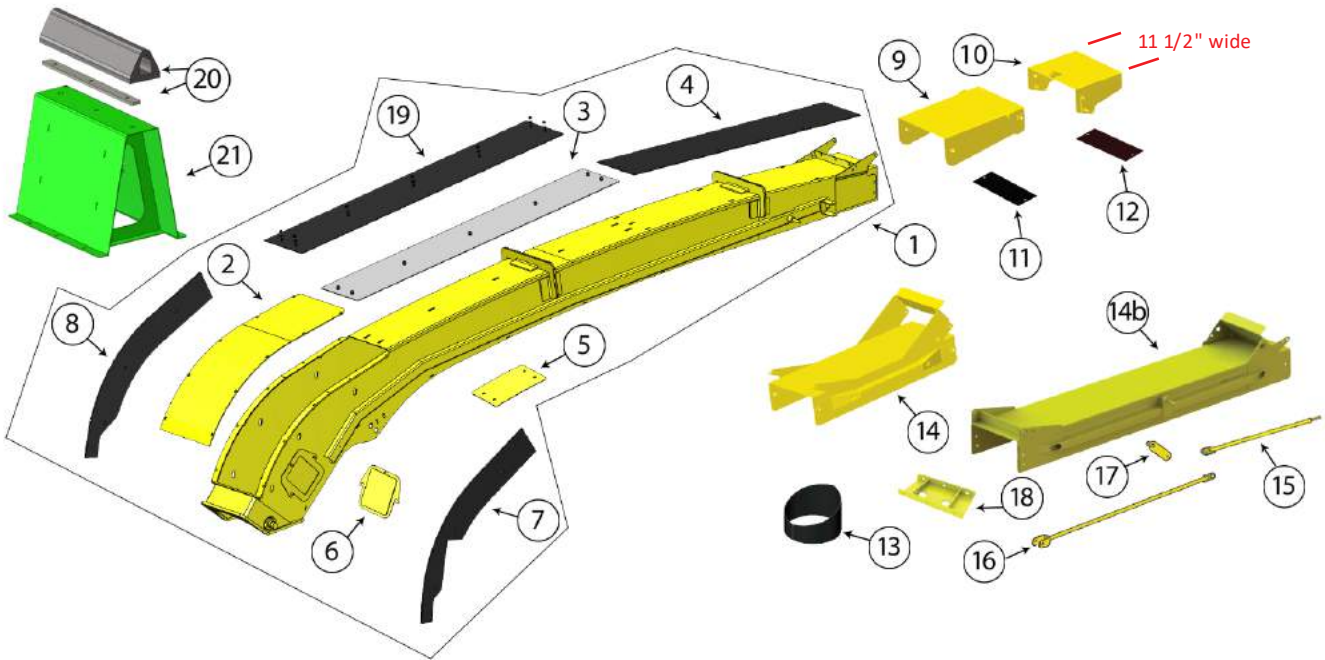

KOOIMA #	DESCRIPTION	REPLACES OEM #
K62973 \$3,100.00 ea.	① • Low-arch spout • Uses high arch spout cylinder • To fit all 7000 series harvesters • 400 lbs.	AZ101238 / AZ62973 Abrasion Resistant
K68680 \$97.45 ea.	② • Lower spout wear plate • To fit 7000 series harvesters with 250mm wide low-arch spout • 29.4 lbs. • Bolt Kit: K68680BK , \$17.30 ea., .5 lbs.	Z68680 Abrasion Resistant
K62973LINF \$90.45 ea.	③ • Upper rear spout wear plate • To fit 7000 series harvesters with 250mm wide low-arch spout • 24.4 lbs.	Abrasion Resistant
K62973LINB \$70.45 ea.	④ • Top rear spout liner • 1 required • 20.7 lbs. • To fit 250mm wide low-arch spouts	Abrasion Resistant
K43921 \$33.85 ea.	⑤ • Access door • One required • To fit 7000 series harvesters with 250mm wide low-arch spout • 2.4 lbs.	AZ43921
K43830D \$25.30 ea.	⑥ • Spout transition inspection door • 3.3 lbs. • To fit all 7000 series harvesters equipped with 200mm spouts	AZ43830 Abrasion Resistant
K68683 (Left) K68684 (Right) \$50.35 ea.	⑦ • Wear plate • To fit 7000 series harvesters with 250mm wide low-arch spout	Z68683 Z68684
K68683BK \$6.00 ea.	⑧a • Wear plate bolt kit • .32 lbs. • To fit K68683 and K68684 wear plate	Abrasion Resistant
K54380 \$67.95 ea.	⑨ • Inner spout deflector • To fit 7000 series harvesters with 250mm wide low-arch spout • 14.6 lbs.	AZ54380 Abrasion Resistant
K54380BK \$11.25 ea.	⑨a • Inner spout deflector bolt kit • To fit #K54380 spout deflector • .35 lbs.	
K53234 \$67.95 ea.	⑩ • Outer spout deflector • To fit 7000 series harvesters 250mm wide low-arch spout • 8 lbs.	AZ53234 Abrasion Resistant
K47896BK \$6.75 ea.	⑩a • Outer spout deflector bolt kit • To fit #K53234 spout deflector • .15 lbs.	
K54381 \$29.30 ea.	⑪ • Inner spout deflector wear plate • To fit #K54380 spout deflector • Bolt-in or weld-in • 5.8 lbs.	Abrasion Resistant
KBK \$3.25 ea.	⑪a • Wear plate bolt kit • .1 lbs. • To fit #K54381 spout deflector wear plate	
K53235 \$29.30 ea.	⑫ • Outer spout deflector wear plate • To fit #K53234 spout deflector • Bolt-in or weld-in • 3.2 lbs.	Abrasion Resistant
KBK \$3.25 ea.	⑫a • Wear plate bolt kit • .1 lbs. • To fit #K53235 spout deflector wear plate	
K54264WL \$79.45 ea.	⑬ • Weld-in transition liner • To fit all 7000 series harvesters • 8 lbs.	Abrasion Resistant
K54418 \$165.75 ea.	⑭ • 36" spout extension • Used with 6 or 8-row headers • Creates space between head and truck when side or top loading • To fit 7000 series equipped w/250mm wide low-arch spout • 39 lbs.	AZ104285 AZ54418 AZ59970 Abrasion Resistant

Truck icon signifies product is shipped via truck freight.

TO ORDER BY FAX CALL 1-712-476-6283

KOOIMA® REPLACEMENT PARTS TO FIT 7000 SERIES JOHN DEERE® 250MM WIDE LOW-ARCH SPOUT

Replacement parts produced by Kooima® Company to fit JD® 7000 Series

KOOIMA #		DESCRIPTION	REPLACES OEM #
K54418BK \$9.25 ea.	(14a)	• Spout extension bolt kit • To fit #K54418 & #K104288 spout extensions • 1.1 lbs.	
K104288 \$615.80 ea.	(14b)	• 5' extension for 250mm spouts • Does not replace end section on JD® OEM spouts • To fit all 7000 series harvesters • 67 lbs.	AZ104288 AXE2511
K104290 \$35.35 ea.	(15)	• Replacement 5' extension link • To be used with K104288 • To fit all 7000 series harvesters • 1.65 lbs.	AZ104290
K104291 \$40.35 ea.	(16)	• Replacement 5' extension link • To be used with K104288 • To fit all 7000 series harvesters • 2.45 lbs.	AZ104291
K104292 \$30.35 ea.	(17)	• Replacement lever for the 5' extension • To be used with K104288 • To fit all 7000 series harvesters • .65 lbs.	AZ104292
K104292BK \$9.75 ea.	(17a)	• Bolt kit • .2 lbs. • To fit #K104292 replacement lever	
K104293 \$61.20 ea.	(18)	• Spout stiffener bracket • To fit all 7000 series harvesters • Supports K104288 5' extension • 4.1 lbs.	AZ104293
K104293BK \$32.85 ea.	(18a)	• Bolt kit • To fit #K104293 bracket • 1 lb.	
K54608 \$95.00 ea.	(19)	• Upper rear spout wear plate • To fit 7000 series harvesters with factory John Deere® spout • 24.7 lbs.	AZ54608 Abrasion Resistant
K69635 \$95.45 ea.	(20)	• Spout rest support kit • 9.53 lbs. • Includes reinforcement bracket and mounting bolts • To fit all 250mm spout rests	Z69635 Z70507
K61312 \$90.45 ea.	(21)	• 250mm spout rest base • 26.5 lbs. • To fit all 6000-7000 series with 250mm spouts • 1 required	AZ61312
K48788BR \$95.45 ea.		• Rear rubber bumper • 13.75" long • To fit all 6000 & 7000 series • 2 required	Z48788



SILAGE TESTER

- Tests freshly chopped and ensiled silage.
- Tester stays clean; plastic bags prevent contamination of test cell.
- Tests in one minute.
- Digital log reading with conversion chart for common silage types.
- Accurate within 2% (average) for silage under 50% moisture.
- Accurate within 3% (average) for silage over 50% moisture.
- Accurate within 1% for grain at normal stored moisture.
- Testing range: 30% - 75% (silage), 10% - 47% (grain).
- Full one year warranty. • 4 lbs.

Silage Tester
Order # K1210
Only
\$325⁸⁰ea.

Replacement Bags
100 Count
Order # K06801
\$25³⁰ea.



HAY PICK-UP TEETH

Kooima® hay pick-up teeth are manufactured from hi-tensile drawn spring wire for uniform strength and durability.



- Pick-up tooth • .35 lbs.
- To fit all John Deere® 5 1/2 ft. forage heads
- Replaces OEM #268SE

Order # K268SE

\$2⁰⁵ea. Bolt Kit:
K268SEBK:
\$4.25 ea.



- Pick-up tooth • .45 lbs.
- To fit all John Deere® 7 1/2 ft. forage harvester hay heads after SN. 550001
- Replaces OEM #E74678

Order # K74678

\$2²⁰ea. Bolt Kit:
K74678BK:
\$3.50 ea.

Order online at WWW.KOOIMA.COM and receive FREE FREIGHT to your door!

KOOIMA®
COMPANY



7000 & 8000 Series Bumper

Features:

- Adjustable bumper pads to protect your cutter from damage
- Lowered hitch allows for better alignment
- Weight rack designed to use standard suitcase weights
- Included chain or tow rope connection
- Proudly made in the USA

675 lbs.

Order # K125061

\$2,950⁰⁰ea.

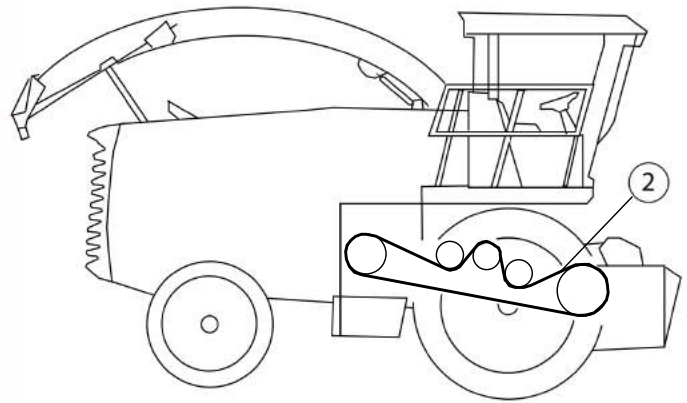
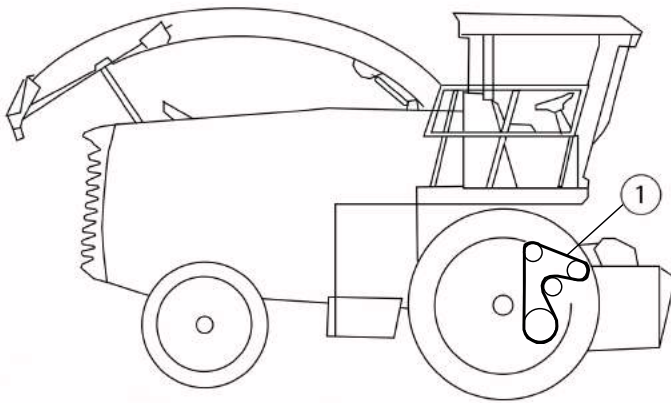
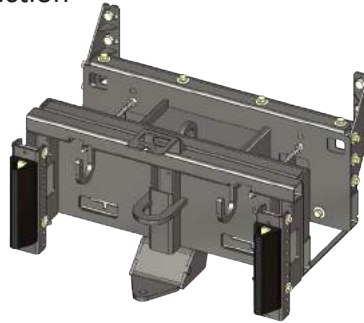

High Quality Gates® Belts

KOOIMA #	DESCRIPTION	REPLACES OEM #
K61336 \$105.00 per set	① • Processor belt (set of 3) • Right side • To fit 7200-7800 machines • 78 1/2" long • 3.8 lbs.	AZ61336
K100808 \$82.45 per set	① • Processor belt (set of 3) To fit 7200-7800 left side • 89" long • 3 lbs. • To fit wide body machines SN. 510523 & below and standard SN. 511027 & below	AZ100808
K101386 \$175.75 per set	① • Processor belt (set of 3) To fit 7750, 7850 & 7950 right side • 80.32" long • 3.7 lbs.	AZ101386
K13957 \$105.75 per set	① • Processor belt (4-groove set) • Left side • To fit 7250-7550 standard body machines SN. 511028 & up • 3.4 lbs.	HXE13957
K13951 \$110.75 per set	① • Processor belt (4-groove set) • Left side • To fit 7750-7980 wide body machines SN. 510524 & up • 3.5 lbs.	HXE13951
K53559 \$945.00 per set	② • Drum belt (6-groove set) • To fit 7200-7550 1000 RPM • 247" long • 36 lbs.	AZ53559
K51638 \$1,070.00 per set	② • Drum belt (7-groove set) • To fit 7200-7850 1150 RPM • 251" long • 37 lbs.	AZ51638

K7000WSC



\$250.75 ea.

- Windshield cover
- To fit all 7000 series harvesters
- Eliminates cracked and broken windshields
- Double sewn heavy duty, padded vinyl construction
- Stainless steel dee rings • 11 lbs.

FREE FREIGHT ON RETAIL ORDERS OVER \$750.00!

Filters Now Available!

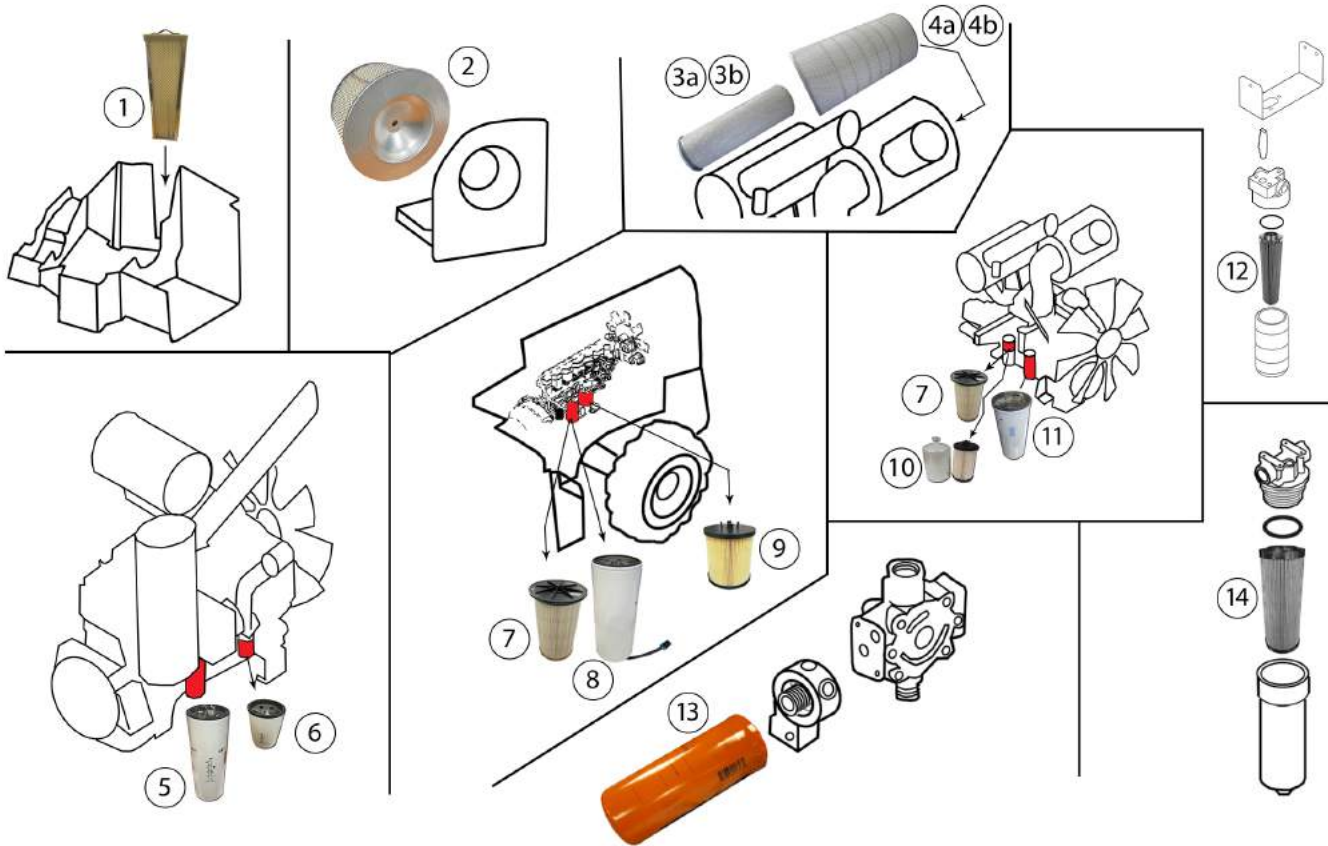

KOOIMA #	DESCRIPTION	REPLACES OEM #
K115836 \$40.35 ea.	① • Air conditioning filter • 1 lb. • To fit 7200-7500, 7700 & 7800 series • Will also fit JD® CTS & STS combines	AH115836
K115833 \$45.35 ea.	② • Cab air filter • 4.5 lbs. • To fit 7200-7980 series • Will also fit JD® CTS & STS combines	AH115833
K45867 \$69.45 ea.	③a • Air cleaner filter • 5 lbs. • To fit 6610-6950, 7200-7500, 7250, 7350, 7180, 7380 series	AZ45867
K61134 \$125.75 ea.	③b • Air cleaner filter • 5 lbs. • To fit 7200-7500, 7700, 7800, 7450-7850, 7280-7780 series	AZ61134
K45868 \$90.45 ea.	④a • Air cleaner filter • 11.05 lbs. • To fit 6610-6950, 7200-7500, 7250, 7350, 7180, 7380 series	AZ45868
K61133 \$89.45 ea.	④b • Air cleaner filter • 11.05 lbs. • To fit 7200-7500, 7700, 7800, 7450-7850, 7280-7780 series	AZ61133
KLF9070 \$58.00 ea.	⑤ • Oil filter • 4.3 lbs. • To fit 7700, 7800 & 7850 series	PMLF9070
KWF2126 \$40.35 ea.	⑥ • Coolant filter • 1.6 lbs. • To fit 7700, 7800 & 7850 series	PMWF2126
K507284 \$29.00 ea.	⑦ • Fuel filter • 1.7 lbs. • To fit 6650-6950, 7200-7500, 7700, 7800, 7350 & 7750	RE507284
K522372 \$43.00 ea.	⑧ • Fuel filter • 3.3 lbs. • To fit 7200-7500 series	RE522372 RE509596
K509672 \$16.00 ea.	⑨ • Oil filter element • .7 lbs. • To fit 7200-7500, 7250, 7180, 8100 & 8200 series	RE509672
K525523 \$60.00 ea.	⑩ • Fuel filter kit • Includes 1 RE520906 & RE523236 • 2.5 lbs. • To fit 7180, 7250-7550 & STS combines	RE525523 RE520906 / RE523236
K58935 \$35.00 ea.	⑪ • Oil filter • 1.7 lbs. • To fit 7200-7500, 7700 & 7800 series	RE58935
K14583 \$35.35 ea.	⑫ • Oil filter • .5 lbs. • To fit 7200-7980 series	AXE14583 AZ64238
K128449 \$29.30 ea.	⑬ • Hydraulic filter • 2.8 lbs. • To fit 7200-7780 series & CTS and STS combines	AH128449
K203060 \$55.35 ea.	⑭ • Transmission & hydraulic oil filter • 1.3 lbs. • To fit 7200-7980 series	AL203060 AL112936

Replacement parts produced by Kooima® Company to fit JD® 7000 Series

TO ORDER CALL TOLL FREE 1-800-522-8874

KOOIMA® REPLACEMENT PARTS TO FIT 8100-8500 SERIES JOHN DEERE® FORAGE HARVESTERS

John Deere® is a registered trademark of Deere & Company, which does not manufacture, distribute or endorse these parts.

8100-8500 Narrow Body

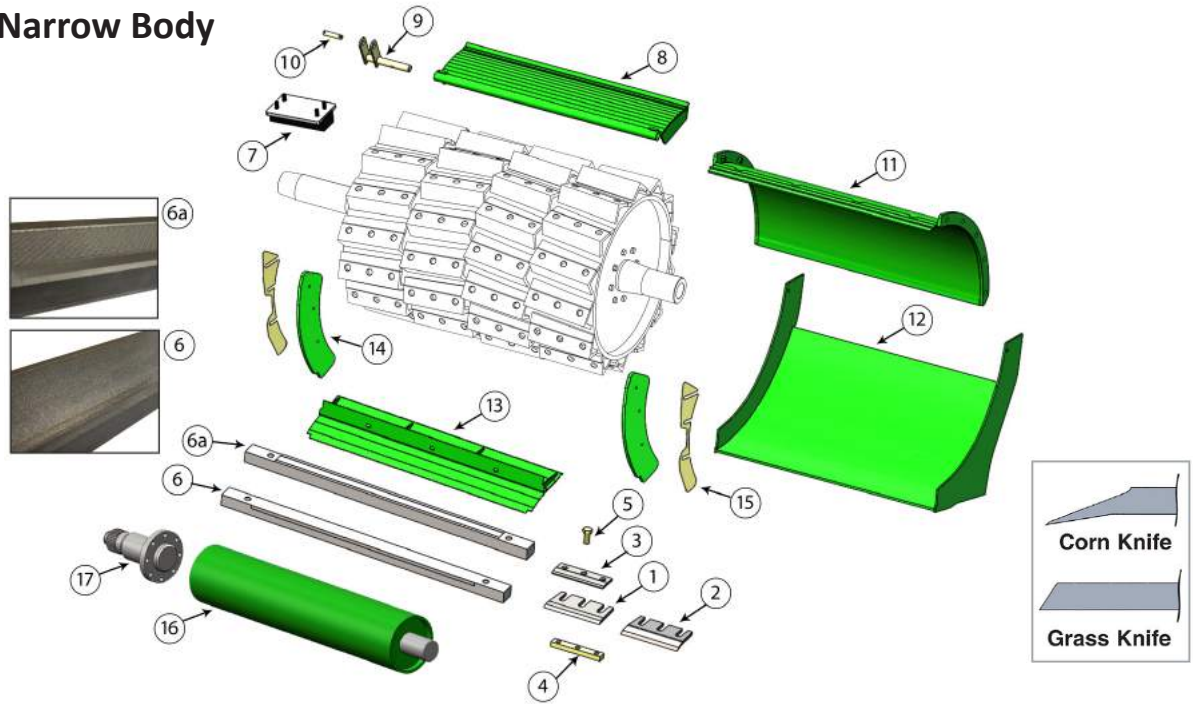

KOOIMA #	DESCRIPTION	REPLACES OEM #
K53568 \$19.90 ea.	① • Grass knife • To fit 8100-8500 series harvesters • 2.05 lbs.	HXE53568 Heat Treated / Tungsten Carbide
K53570 \$21.40 ea.	② • Corn knife • To fit 8100-8500 series harvesters • 1.96 lbs.	HXE53570 Heat Treated / Tungsten Carbide
K53571 \$17.05 ea.	③ • Top strap • 1 lb. • To fit 8100-8500 series	HXE53571 Heat Treated
K71196 \$7.75 ea.	④ • Bottom nut • .9 lbs. • To fit 8100-8500 series harvesters	Z71196 / Z49625
K29393 \$2.90 ea.	⑤ • Knife bolt • 10.9 metric • .25 lbs. • To fit 8100-8800 series • 3 bolts per knife required	HXE29393
K86990 \$405.80 ea.	⑥ • Corn shearbar • To fit 8100-8500 series harvesters • 25 lbs.	HXE86991 / HXE101351 Heat Treated / Tungsten Carbide
K86990HP \$490.00 ea.	⑥a • High performance universal shearbar • To fit 8100-8500 series harvesters • 26 lbs.	HXE86990 / HXE101352 Heat Treated / Tungsten Carbide
K17437 \$78.95 ea.	⑦ • Sharpening stone • 3 lbs. • To fit 8100-8800 series	AXE17437
K18731 \$130.00 ea.	⑧ • Knife sharpening door • 14.5 lbs. • To fit 8100-8500 series (8600: SN# 619000 and above)	AXE18731
K18775 \$56.60 ea.	⑨ • Knife sharpening door lever • 1.2 lbs. • To fit 8100-8800 series	AXE18775 / AXE70742
K18775BK \$1.70 ea.	⑨a • Knife sharpening door lever hardware • .05 lbs. • To fit K18775 lever, includes 2 cotter pins & 2 spring pins	11M7021/34M7217/34M7214
K79793 \$7.75 ea.	⑩ • Knife sharpening door pin • .22 lbs. • To fit 8100-8800 series	HXE79793
K45063 \$195.75 ea.	⑪ • Cutter housing back band • 35.3 lbs. • To fit 8100-8500 series	AXE45063
K41753 \$445.80 ea.	⑫ • Spiral band • To fit 8100-8500 series	AXE71513 / AXE41753
K49935 \$120.75 ea.	⑬ • Front cover • 12.85 lbs. • To fit 8100-8500 series	AXE49935
K84524 \$49.60 ea.	⑭ • Cutter housing wear plate • 4.65 lbs. • To fit 8100-8800 series	HXE84524
K76993 \$6.55 ea.	⑮ • Wear plate shim • .25 lbs. • To fit 8100-8800 series	HXE76993
K14074 \$430.00 ea.	⑰ • Lower rear smooth roll • 42 lbs. • To fit 8100-8500 series harvesters	AXE14074
K19677 \$305.00 ea.	⑰ • Lower rear smooth roll drive flange • 7 lbs. • To fit 8100-8800 series harvesters	HXE19677

Replacement parts produced by Kooima® Company to fit JD® 8000 Series

8600-8800 Wide Body

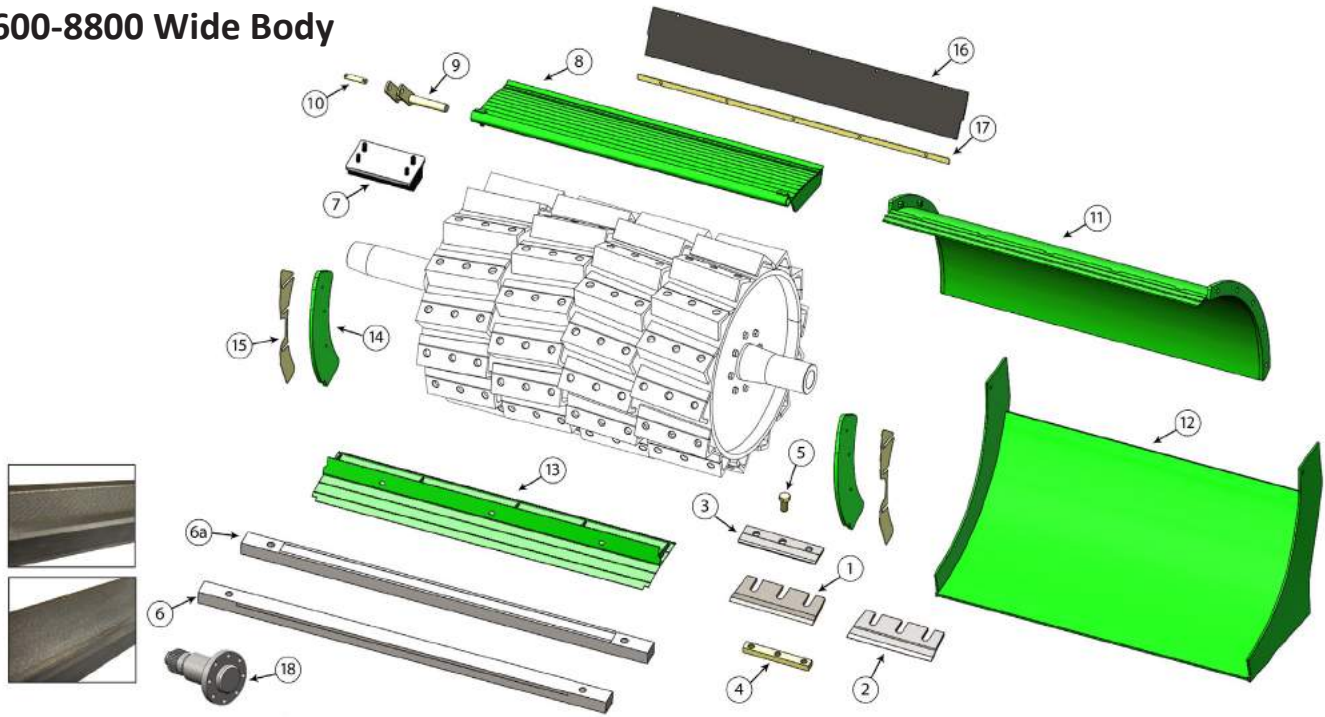

Replacement parts produced by Kooima® Company to fit JD® 8000 Series

KOOIMA #	DESCRIPTION	REPLACES OEM #
K52933 \$22.75 ea. (1)	• Grass knife • To fit 8600-8800 series harvesters • 2.7 lbs.	HXE52933 Heat Treated / Tungsten Carbide
K52950 \$25.60 ea. (2)	• Corn knife • To fit 8600-8800 series harvesters • 2.7 lbs.	HXE52950 Heat Treated / Tungsten Carbide
K52938 \$13.00 ea. (3)	• Top strap • 1.23 lb. • To fit 8600-8800 series	HXE119923 / HXE52938 Heat Treated / Tungsten Carbide
K72498 \$9.10 ea. (4)	• Bottom Nut • .95 lbs. • To fit 8600-8800 series harvesters	Z72498/ HXE29392
K29393 \$2.90 ea. (5)	• Knife bolt • 10.9 metric • .25 lbs. • To fit 8100-8800 series • 3 bolts per knife required	HXE29393
K86980 \$500.80 ea. (6)	• Corn shearbar • 29 lbs. • To fit 8600-8800 series • 25 lbs.	HXE101350 / HXE86980 Heat Treated / Tungsten Carbide
K86911HP \$590.00 ea. (6a)	• High performance universal shearbar • 30 lbs. • To fit 8600-8800 series	HXE101349 / HXE86911 Heat Treated / Tungsten Carbide
K17437 \$78.95 ea. (7)	• Sharpening stone • 3 lbs. • To fit 8100-8800 series	AXE17437
K18541 \$213.55 ea. (8)	• Knife sharpening door • 14.5 lbs. • To fit 8600-8800 series (8600: SN# 18999 and below)	AXE18541
K18775 \$56.60 ea. (9)	• Knife sharpening door lever • 1.2 lbs. • To fit 8100-8800 series	AXE18775 / AXE70742
K18775BK \$1.70 ea. (9a)	• Knife sharpening door lever hardware • .05 lbs. • To fit K18775 lever, includes 2 cotter pins & 2 spring pins	11M7021/34M7217/34M7214
K79793 \$7.75 ea. (10)	• Knife sharpening door pin • .22 lbs. • To fit 8100-8800 series	HXE79793
K45056 \$216.00 ea. (11)	• Cutter housing back band • 46.8 lbs. • To fit 8600-8800 series	AXE45056
K41319 \$567.15 ea. (12)	• Spiral band • To fit 8600-8800 series	AXE72022 / AXE41319
K49888 \$135.75 ea. (13)	• Front cover • 10.35 lbs. • To fit 8600-8800 series	AXE49888
K84524 \$49.60 ea. (14)	• Cutter housing wear plate • 4.65 lbs. • To fit 8100-8800 series	HXE84524
K76993 \$6.55 ea. (15)	• Wear plate shim • .25 lbs. • To fit 8100-8800 series	HXE76993
K78798 \$13.80 ea. (16)	• Rubber cover • To fit 8600-8800 series	HXE78798
K78933 \$11.85 ea. (17)	• Rubber cover strap • .82 lbs. • To fit 8600-8800 series	HXE78933
K19677 \$305.00 ea. (18)	• Lower rear smooth roll drive flange • 7 lbs. • To fit 8100-8800 series harvesters	HXE19677

TO ORDER CALL TOLL FREE 1-800-522-8874

KOOIMA® REPLACEMENT PARTS TO FIT 8000 SERIES JOHN DEERE® FORAGE HARVESTERS

8100-8500 Narrow Body

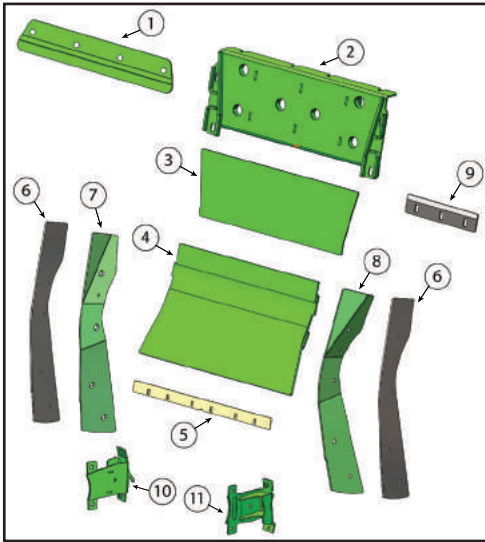

8600-8800 Wide Body

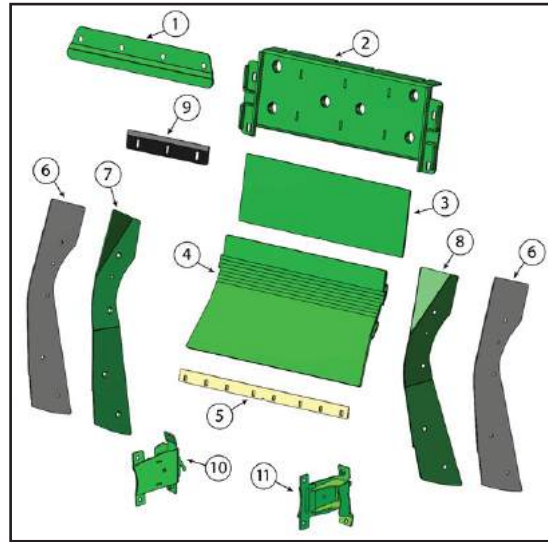

Replacement parts produced by Kooima® Company to fit JD® 8000 Series

KOOIMA #	DESCRIPTION	REPLACES OEM #
Parts for Narrow Body 8100-8500 Series Blowers		
K53728	• Blower housing deflector • 4.25 lbs.	HXE53728
\$31.35 ea.	• To fit 8100-8800 series SN. 513822 and above	Abrasion Resistant
K46593	• Rear blower door • 21 lbs.	AXE46593
\$130.75 ea.	• To fit 8100-8500 series SN. 513822 and above	Abrasion Resistant
K46619	• Rear blower door wear plate • 4.8 lbs.	AXE46619
\$95.45 ea.	• To fit 8100-8500 series SN. 513822 and above	Abrasion Resistant
K41235	• Blower band • 38.6 lbs.	AXE41235
\$300.80 ea.	• To fit 8100-8500 series SN. 513822 and above	Abrasion Resistant
K37140	• Blower strap • 1.45 lbs.	HXE37140
\$12.75 ea.	• To fit 8100-8500 series SN. 513822 and above	
K63268	• Blower side liner • 6 lbs. • 2 required	HXE63268 / HXE115531
\$60.45 ea.	• To fit 8100-8800 series SN. 513822 and above	UHMW Plastic
K40375	• RH Blower housing plate • 5.95 lbs.	HXE40375 / HXE115394
\$100.75 ea.	• To fit 8100-8500 series SN. 513822 and above	Abrasion Resistant
K40374	• LH Blower housing plate • 5.95 lbs.	HXE40374 / HXE115395
\$100.75 ea.	• To fit 8100-8500 series SN. 513822 and above	Abrasion Resistant
K37067	• Blower paddle - Koyma Klad® coating • 1.3 lbs. • 10 required	HXE37067
\$19.80 ea.	• To fit 8100-8500 series SN. 513822 and above	Koyma Klad/Heat Treated
KM12BK	• Blower paddle bolt kit • Includes 3 bolts & 3 nuts	03M7199
\$8.05 ea.	• 1 kit per paddle required • .5 lbs.	14M7401
K25499	• Right hand support	AXE25499
\$105.75 ea.	• To fit 8100-8800 series SN. 513822 and above	
K37014	• Left hand support	AXE37014
\$95.45 ea.	• To fit 8100-8800 series SN. 513822 and above	
Parts for Wide Body 8600-8800 Series Blowers		
K53728	• Blower housing deflector • 4.25 lbs.	HXE53728
\$31.35 ea.	• To fit 8100-8800 series SN. 513822 and above	Abrasion Resistant
K46602	• Rear blower door • 22 lbs.	AXE46602
\$130.75 ea.	• To fit 8600-8800 series SN. 513822 and above	Abrasion Resistant
K46618	• Rear blower door wear plate • 10.7 lbs.	AXE46618
\$95.45 ea.	• To fit 8600-8800 series SN. 513822 and above	Abrasion Resistant
K35811	• Blower housing blower band • 43.5 lbs.	AXE35811
\$350.80 ea.	• To fit 8600-8800 series SN. 513822 and above	Abrasion Resistant
K31527	• Blower strap • 1.65 lbs.	HXE31527
\$12.75 ea.	• To fit 8600-8800 series SN. 513822 and above and 9600-9900 series SN 619000 and above	
K63268	• Blower side liner • 6 lbs. • 2 required	HXE63268
\$60.45 ea.	• To fit 8100-8800 series SN. 513822 and above	UHMW
K63191	• RH Blower housing wear plate • 5.95 lbs.	HXE63191 / HXE115396
\$60.45 ea.	• To fit 8100-8500 series SN. 513822 and above	Abrasion Resistant
K63192	• LH Blower housing wear plate • 5.95 lbs.	HXE63192 / HXE115397
\$60.45 ea.	• To fit 8100-8800 series SN. 513822 and above	Abrasion Resistant
K29814	• Blower paddle - Koyma Klad® coating • 1.4 lbs. • 10 required	HXE29814
\$22.30 ea.	• To fit 8600-8800 series SN. 513822 and above	Koyma Klad/Heat Treated
KM12BK	• Blower paddle bolt kit • Includes 3 bolts & 3 nuts	03M7199
\$8.05 ea.	• 1 kit per paddle required • .5 lbs.	14M7401
K25499	• Right hand support	AXE25499
\$105.75 ea.	• To fit 8100-8800 series SN. 513822 and above	
K37014	• Left hand support	AXE37014
\$95.45 ea.	• To fit 8100-8800 series SN. 513822 and above	

7000, 8000 & 9000 Series Bumper

Features:





- Adjustable bumper pads to protect your cutter from damage
- Lowered hitch allows for better alignment
- Weight rack designed to use standard suitcase weights
- Included chain or tow rope connection
- Proudly made in the USA

675 lbs.

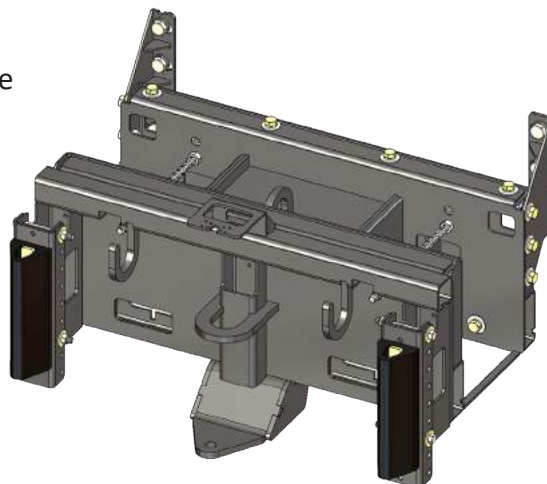
Order # K125061

\$2,950⁰⁰ea.



KOOIMA #	DESCRIPTION	REPLACES OEM #
K93580 \$90.45 ea.	 • Upper front feed roll tooth • 2 lbs. • To fit John Deere® 8200-8500 series • 10 required	HXE93580 / HXE87699 Stainless
K93575 \$90.45 ea.	 • Upper front feed roll tooth • 2.6 lbs. • To fit John Deere® 8600-8800 series • 10 required	HXE93575 Stainless
K55068 \$90.45 ea.	 • Lower front feed roll tooth • 1.6 lbs. • To fit John Deere® 8200-8500 series • 12 required	HXE55068 / HXE100098 Stainless
K54553 \$80.45 ea.	 • Lower front feed roll tooth • 2 lbs. • To fit John Deere® 8600-8800 series • 12 required	HXE54553 / HXE100097 Stainless

KOOIMA #	DESCRIPTION	REPLACES OEM #
K43638HPF (Fast, Top 118 tooth) K43638HPS (Slow, Bottom 130 tooth) \$1,975.00 ea.	• Kernel processor roll • 166 lbs. • Chevron Series Fiber Tech - High Capacity • To fit 8100-8500 series	AXE43638 Heat Treated Chromed

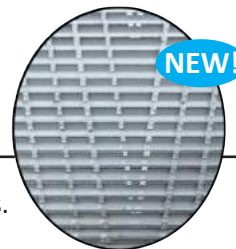

K43163HPF (Fast, Top 118 tooth) K43182HPS (Slow, Bottom 130 tooth) \$2,025.00 ea.	• Kernel processor roll • 206 lbs. • Chevron Series Fiber Tech High Capacity Rolls To fit 8600-8800 series	AXE43163 AXE43182 Heat Treated Chromed
---	--	---



Square grooves unwrap cellulose and shred your stalk which also creates a far superior process job.

K59430 \$125.75 ea.	 • Roller bearing • To fit 8000 series processors • 2 required per roll	AXE59430 AXE44429
-------------------------------	--	----------------------



KOOIMA® REPLACEMENT PARTS TO FIT 8000 SERIES JOHN DEERE® FORAGE HARVESTERS

Replacement parts produced by Kooima® Company to fit JD® 8000 Series

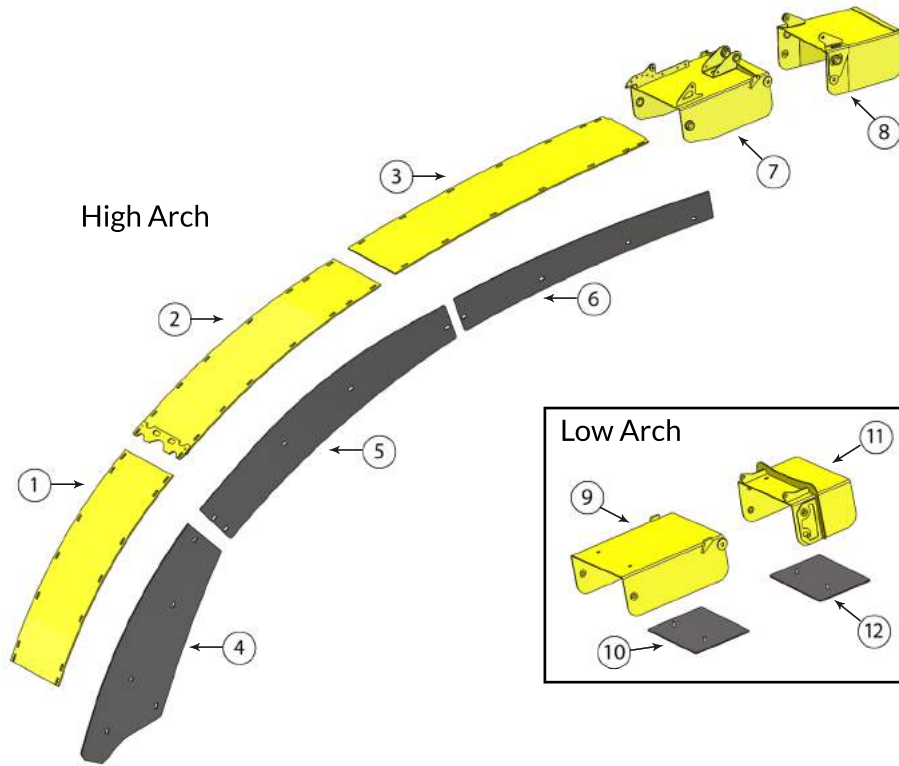

<u>KOOIMA #</u>	<u>DESCRIPTION</u>	<u>REPLACES OEM #</u>
K43969 \$120.75 ea. (1)	<ul style="list-style-type: none"> • Lower rear wear plate • 25 lbs. • To fit all 8000 series high arch spouts • Hardware Kit: K43969BK - \$11.25 ea., .9 lbs. 	HXE43969 Abrasion Resistant
K25517 \$120.00 ea. (2)	<ul style="list-style-type: none"> • Middle rear wear plate • 28.5 lbs. • To fit all 8000 series high arch spouts • Hardware Kit: K25517BK - \$15.30 ea., 1.44 lbs. 	AXE25517 Abrasion Resistant
K39391 \$130.75 ea. (3)	<ul style="list-style-type: none"> • Top rear wear plate • 31.4 lbs. • To fit all 8000 series high arch spouts • Hardware Kit: K39391BK - \$15.30 ea., 1.26 lbs, 	HXE39391 Abrasion Resistant
K33265 \$90.45 ea. (4)	<ul style="list-style-type: none"> • Bottom side wear plate • 20 lbs. • To fit all 8000 series high arch spouts • 2 required • Hardware Kit: K33265BK - \$8.25 ea., .55 lbs. 	HXE33265 Abrasion Resistant
K33266 \$60.45 ea. (5)	<ul style="list-style-type: none"> • Middle side liner • 10.6 lbs. • To fit all 8000 series high arch spouts • 2 required • Hardware Kit: K33266BK - \$15.30 ea., 1.05 lbs. 	HXE33266 Abrasion Resistant
K34370 \$52.85 ea. (6)	<ul style="list-style-type: none"> • Top side liner • 6.5 lbs. • To fit all 8000 series high arch spouts • 2 required • Hardware Kit: K34370BK - \$6.25 ea., .4 lbs. 	HXE34370 Abrasion Resistant
K52630 \$185.75 ea. (7)	<ul style="list-style-type: none"> • Inner spout deflector • 20 lbs. • To fit all 8000 series with high arch spouts 	AXE52630 Abrasion Resistant
K55539 \$185.75 ea. (8)	<ul style="list-style-type: none"> • Outer spout deflector • 17 lbs. • To fit all 8000 series with high arch spouts 	AXE55539 Abrasion Resistant
Parts for 8000 Series Low-Arch Spouts		
K45117 \$125.75 ea. (9)	<ul style="list-style-type: none"> • Inner spout deflector • 16.6 lbs. • To fit all 8000 series with low arch spouts 	AXE45117 Abrasion Resistant
K46392 \$40.10 ea. (10)	<ul style="list-style-type: none"> • Inner spout deflector liner • 4.15 lbs. • To fit all 8000 series with low arch spouts • Hardware Kit: K46392BK - \$2.90 ea., .05 lbs. 	AXE46392 Abrasion Resistant
K45096 \$185.75 ea. (11)	<ul style="list-style-type: none"> • Outer spout deflector • 12.4 lbs. • To fit all 8000 series with low arch spouts 	AXE45096 Abrasion Resistant
K46393 \$40.10 ea. (12)	<ul style="list-style-type: none"> • Outer spout deflector liner • 4.1 lbs. • To fit all 8000 series with low arch spouts • Hardware Kit: K46392BK - \$2.90 ea., .05 lbs. 	AXE46393 Abrasion Resistant

KOOIMA® REPLACEMENT PARTS TO FIT 3000 SERIES JOHN DEERE® FORAGE HARVESTERS

John Deere® and JD® are registered trademarks of Deere & Company, which does not manufacture, distribute or endorse these parts.

Replacement parts produced by Kooima® Company to fit JD® 3000 Series

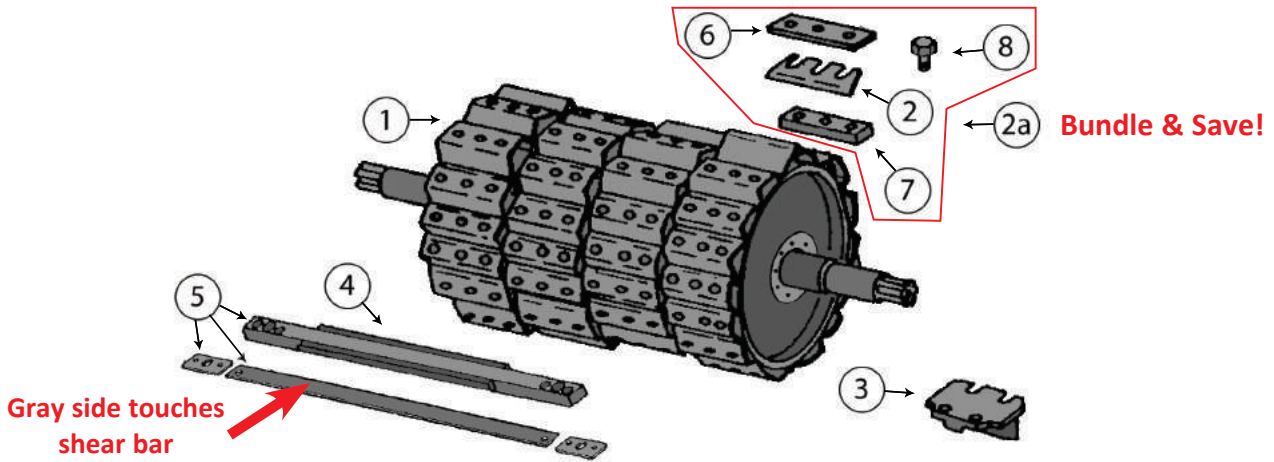

KOOIMA

3000CON (w/o knives and hardware)

\$2,450.00

K3000CON (complete w/knives & hardware)

\$3,700.00

①



DESCRIPTION

- Replacement cutterhead assembly
- To fit JD® 3960 & 3970 series
- Heavy duty 1/2" thick end walls
- 1/2" center support inside drum eliminates center cracking
- New bolt-in replacement shaft • 285 lbs. 

REPLACES OEM

AFH206108
AE43856

K61962

\$11.75 ea.

②

- Knife • To fit all **3940, 3950 & 3955**
- Also fits New Holland® Dura-drum™ • 36 required • 1 lb.

E61962/FH310957
Heat Treated/Tungsten Carbide

K61962KIT

\$25.60 ea.

②a

- Buy (1) K61962, (1) K78596, (1) K61960, (3) K62538 • 2.6 lbs.
- Buy any quantity and save! • To fit all **3940, 3950 & 3955**

K61962HP

\$16.25 ea.

②b

- **Hi-performance knife** • To fit all **3940, 3950 & 3955**
- **Thicker tungsten carbide edge** • 1.1 lbs.

E61962/FH310957
Heat Treated/Tungsten Carbide

K61961

\$11.75 ea.

②c

- Knife • To fit all **3960, 3970 & 3975**
- 48 required • .9 lbs. ea.

E61961/FH310956
Heat Treated/Tungsten Carbide

K61961KIT

\$25.60 ea.

②a

- Buy (1) K61961, (1) K78596, (1) K61960, (3) K62538 • 2.5 lbs.
- Buy any quantity and save! • To fit all **3960, 3970 & 3975**

K61961HP

\$16.25 ea.

②d

- **Hi-performance knife** • To fit all **3960, 3970 & 3975**
- **Thicker tungsten carbide edge** • 1 lb. ea.

E61961/FH310956
Heat Treated/Tungsten Carbide

K46064

\$47.00 ea.

③

- Sharpening stone • To fit all **3940, 3950, 3955, 3960, 3970 & 3975**
- 2.6 lbs. • **Hardware Kit: K46064BK**, \$2.65 ea., .20 lbs.

AE46064

K72918

\$190.00 ea.

④

- Shearbar
- To fit **3940, 3950 & 3955** • 17 lbs.

E72918

Tungsten Carbide

K72919

\$215.00 ea.

④a

- Shearbar
- To fit **3960, 3970 & 3975** • 18 lbs.

E72919/AE44466

Tungsten Carbide

K44465

\$225.00 ea.

⑤

- Shearbar kit • To fit **3940, 3950 & 3955**
- Includes wear strip and bearings • 18 lbs.

AE44465

Tungsten Carbide

K44466

\$240.00 ea.

⑤a

- Shearbar kit • To fit **3960, 3970 & 3975**
- Includes wear strip and bearings • 19 lbs.

AE44466

Tungsten Carbide

K44466BK

\$30.00 ea.

⑤b

- Bolt kit
- To fit K44465 & K44466 • 1.4 lbs.

K78596

\$5.25 ea.

⑥

- Top strap • 36 required, **3940, 3950 & 3955**
- 48 required, **3960, 3970 & 3975** • .65 lbs.

E78596/FH312001

Heat Treated

K61960

\$6.50 ea.

⑦

- Nut • 36 required, **3940, 3950 & 3955**
- 48 required, **3960, 3970 & 3975** • .65 lbs.

E61960

FH312164

K62538

\$1.15 ea.

⑧

- Knife bolt, grade 8 • 108 required, **3940, 3950 & 3955**
- 144 required, **3960, 3970 & 3975** • .1 lbs.

FH323005/E62538

E83034

Truck icon signifies product is shipped via truck freight.

Podemos tomar órdenes en español! : 1-800-522-8874 • By fax: 712-476-6283 • Online: www.kooima.com

KOOIMA®
COMPANY



KOOIMA® REPLACEMENT PARTS TO FIT 3000 SERIES JOHN DEERE® FORAGE HARVESTERS

Replacement parts produced by Kooima® Company to fit JD® 3000 Series

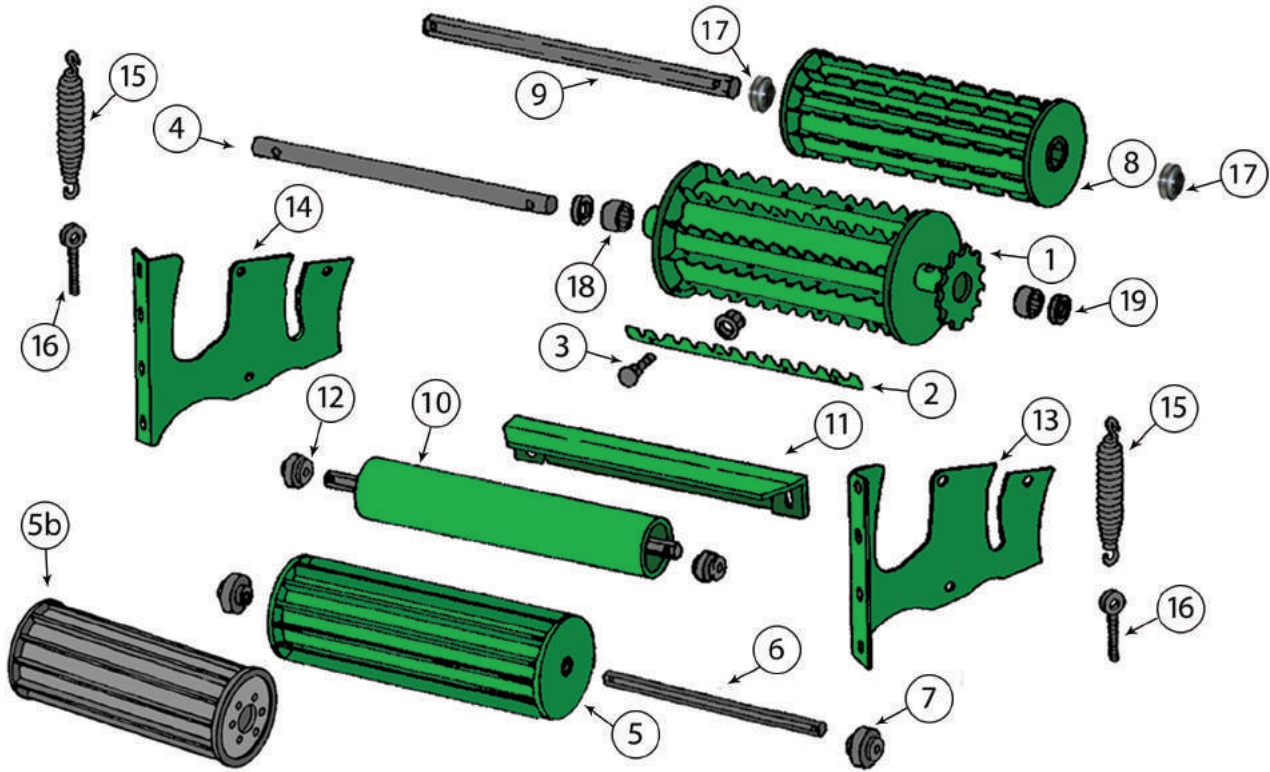

KOOIMA #	DESCRIPTION	REPLACES OEM #
K41907 \$325.80 ea.	① • Upper front feed roll • To fit 3940, 3950 & 3955 without metal detector • Complete with replaceable, abrasion resistant teeth and bearings • 60 lbs.	AE41907
K41469 \$350.80 ea.	①a • Upper front feed roll • To fit 3960, 3970 & 3975 without metal detector • Complete with replaceable, abrasion resistant teeth and bearings • 60.5 lbs.	AE41469
K41908 \$19.80 ea.	② • Upper front feed roll tooth • To fit Kooima® roll #K41907 • 10 required, hardware included in full set of 10 • .9 lbs.	Abrasion Resistant
K41470 \$27.80 ea.	②a • Upper front feed roll tooth • To fit Kooima® roll #K41469 • 10 required, hardware included in full set of 10 • 1.1 lbs.	Abrasion Resistant
K41470BK \$18.25 ea.	③ • Upper front feed roll tooth bolt kit • To fit Kooima® feed roll • To fit all 3000 series harvesters • 2 lbs.	
K72470 \$88.45 ea.	④ • Upper front feed roll shaft • To fit 3940, 3950 & 3955 • Use with roll #K41907 • 26-5/16" x 1-3/8" round shaft • 11.2 lbs.	E72470
K72468 \$80.45 ea.	④a • Upper front feed roll shaft • To fit 3960, 3970 & 3975 • Use with roll #K41469 • 30-5/16" x 1-3/8" round shaft • 12.9 lbs.	E72468
K44165 \$225.75 ea.	⑤ • Lower front feed roll • To fit 3940, 3950 & 3955 without metal detectors • 46 lbs.	AE44165 Abrasion Resistant
K44164 \$305.80 ea.	⑤a • Lower front feed roll • To fit 3960, 3970 & 3975 without metal detector • 54 lbs.	AE44164 Abrasion Resistant
K42646 \$995.80 ea.	⑤b • Lower front feed roll • 43.7 lbs. • To fit 3970 & 3975 with metal detector • Bolt kit: K42646BK , \$19.25 ea.	AE42646 Stainless Steel
K62679 \$70.45 ea.	⑥ • Lower front feed roll shaft • To fit 3940, 3950 & 3955 without metal detector • 25" x 1-1/4" hex shaft • 9.3 lbs.	E62679 Stress Proof Shaft
K62407 \$60.45 ea.	⑥a • Lower front feed roll shaft • To fit 3960, 3970 & 3975 without metal detector • 29" x 1-1/4" hex shaft • 12 lbs.	E62407 Stress Proof Shaft
K37057 \$49.85 ea.	⑦ • Lower front feed roll bearing • To fit all 3000 series • 1 lb.	AE37057
K43833R \$195.75 ea.	⑧ • Upper rear feed roll • To fit 3940, 3950 & 3955 • 25.5 lbs.	AE43833 Abrasion Resistant
K43832 \$220.00 ea.	⑧a • Upper rear feed roll • To fit 3960, 3970 & 3975 • 33 lbs.	AE43832 Abrasion Resistant
K81584 \$45.35 ea.	⑨ • Upper rear feed roll shaft • 6.1 lbs. • To fit 3940, 3950 & 3955 • 26-5/8" x 1" hex shaft	E81584 Stress Proof Shaft
K81583 \$57.85 ea.	⑨a • Upper rear feed roll shaft • To fit 3960, 3970 & 3975 harvesters • 30-5/8" x 1" hex shaft • 7 lbs.	E81583 Stress Proof Shaft

KOOIMA® REPLACEMENT PARTS TO FIT 3000 SERIES JOHN DEERE® FORAGE HARVESTERS

Replacement parts produced by Kooima® Company to fit JD® 3000 Series

KOOIMA #	DESCRIPTION	REPLACES OEM #
K49949 \$225.75 ea.	⑩ • Lower rear smooth feed roll • Complete with hex shaft • To fit 3940, 3950 & 3955 harvesters • 35.5 lbs.	AE49949/AFH205946
K49948 \$240.00 ea.	⑩a • Lower rear smooth feed roll • Complete with hex shaft • To fit 3960, 3970 & 3975 harvesters • 41.4 lbs.	AE49948/AFH205935
K44959 \$95.45 ea.	⑪ • Smooth roll cleaner • 5.9 lbs. • To fit 3940, 3950 & 3955 harvesters • Hardware Kit: K44959BK, \$4.50 ea., .25 lbs.	AE44959/AFH205889
K44960 \$147.00 ea.	⑪a • Smooth roll cleaner • 7 lbs. • To fit 3960, 3970 & 3975 harvesters • Hardware Kit: K44959BK, \$4.50 ea., .25 lbs.	AE44960/AFH205881
K49017 \$60.45 ea.	⑫ • Lower rear feed roll bearing • To fit all 3000 series • 1.1 lbs.	AE49017
K83069 (Left) K83070 (Right) \$53.35 ea.	⑬ • Feed roll housing wear plate • 6.9 lbs. ea. • Made of high carbon steel	E83069/E62414/E92512 E83070/E62415/E92511
K64796 \$63.45 ea.	⑭ • To fit all 3000 series • Hardware Kit: K83069BK, \$6.25 ea., .68 lbs. Abrasion Resistant/Tungsten Carbide ⑮ • Rear feed roll spring • To fit all 3000 series SN. 638416 and after • 12 lbs.	Z67236 / E64796
K82550 \$13.80 ea.	⑯ • Eye bolt • To fit all 3000 series SN. 638416 and after • .6 lbs.	E82550
K9438 \$28.55 ea.	⑰ • Upper rear feed roll bearing • 2 required • .6 lbs.	JD9438/AFH202185
K9865 \$10.00 ea.	⑱ • Bearing upper front feed roll • 2 required • .2 lbs.	JD9865
K53699 \$4.00 ea.	⑲ • Seal upper front feed roll • 2 required • .1 lbs.	E53699



The Rock Stop'er Pro

FORAGE HARVESTER STONE DETECTION SYSTEM



JD® must have double spring kit installed.

- Fits most makes and models of SPFH and pull type harvesters.
- Patented Inertia sensor stops feed drive when rocks are detected.
- In cab sensitivity adjustment for varying crop conditions.
- Call **1-800-522-8874** for more details!



Extra Sensor Available!
Order # SENSOR
Only **\$750⁸⁰** ea.

Order # ROCK STOPER
Only **\$2,950⁰⁰** ea.



Designed and manufactured in Canada.

Check out our Newly Redesigned website!

www.kooima.com



24/7 access to order!



Free shipping on retail web orders in the Continental U.S.!
(Some exclusions apply)



Watch videos of our products!

Order online at WWW.KOOIMA.COM and receive FREE FREIGHT to your door!

KOOIMA® REPLACEMENT PARTS TO FIT 3000 SERIES JOHN DEERE® FORAGE HARVESTERS

Replacement parts produced by Kooima® Company to fit JD® 3000 Series

KOOIMA #
K37442HP

\$890.00 ea.

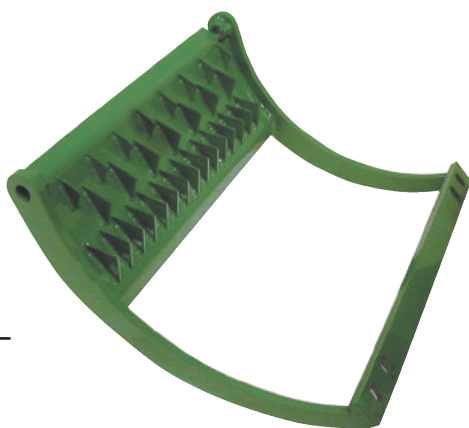

DESCRIPTION

- Cracker plate
- To fit **3940, 3950 & 3955** harvesters
- Cracks 85-90% of kernels with minimal power requirements
- Bolt-in installation
- No moving parts to maintain
- Use in whole plant corn silage or to grind earlage
- Patent #6,234,072 & #6,327,970
- 34.8 lbs.

REPLACES OEM #

**Abrasion Resistant
Heat Treated
Tungsten Carbide**

K37441HP

\$890.00 ea.

- Cracker plate
- To fit **3960, 3970 & 3975** harvesters
- Cracks 85-90% of kernels with minimal power requirements
- Bolt-in installation
- No moving parts to maintain
- Use in whole plant corn silage or to grind earlage
- Patent #6,234,072 & #6,327,970
- 38.4 lbs.

**Abrasion Resistant
Heat Treated
Tungsten Carbide**

K70807DC

\$1,275.00 ea.



- Processor Roll
- Dual cut design for more efficiency
- To Fit John Deere® 3975 series with factory kernel processor
- 2 required • 130 lbs.

AE70807
AE59523
Heat Treated

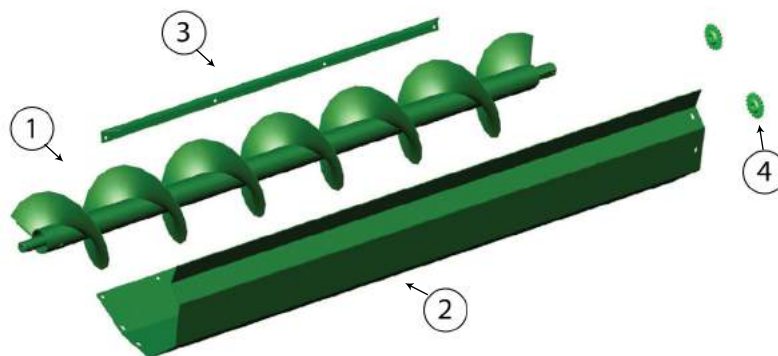

KOOIMA #

K37283
\$415.00 ea.

①

DESCRIPTION

- Auger • To fit all **3940, 3950, 3955, 3960, 3970 & 3975** harvesters **with non-cantilevered auger** • Has support on left hand side • 65.9 lbs.

REPLACES OEM #

AE37283

K44521
\$205.75 ea.

②

- Auger trough • To fit all **3940, 3950, 3955, 3960, 3970 & 3975** harvesters **with non-cantilevered auger** • 78 lbs.

AE44521

K51715
\$205.75 ea.

②a

- Auger trough • To fit **3940, 3950, 3955, 3960, 3970 & 3975** harvesters **with cantilevered auger** • 61.3 lbs.

AE51715

K62524
\$27.30 ea.

③

- Auger stripper angle • 5.1 lbs.
- To fit all 3000 series • **Bolt Kit: K62524BK, \$6.10 ea.**

E62524

Abrasion Resistant

K16773

④

- Auger drive idler sprocket
- To fit all 3000 series harvesters
- 2 required • .4 lbs.

AH16773

\$12.35 ea.

Truck icon signifies product is shipped via truck freight.

FREE FREIGHT ON RETAIL ORDERS OVER \$750.00!

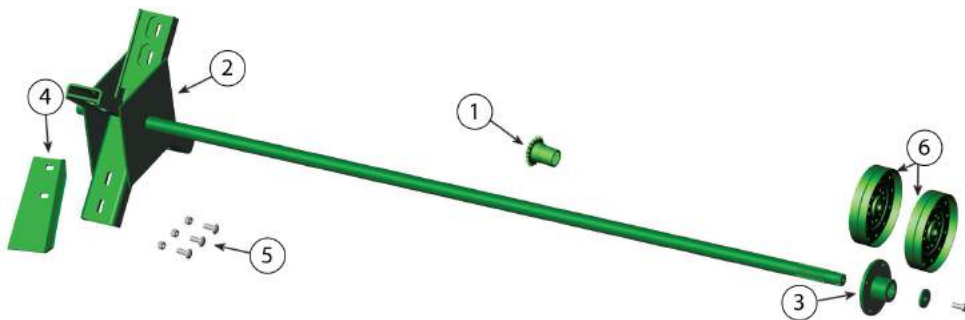

KOOIMA #	DESCRIPTION	REPLACES OEM #
K37289 \$64.95 ea.	① • Drive sprocket • To fit all 3900 series pull types • 1.5 lbs.	AE37289 AFH205831
K41606 \$579.00 ea.	② • Fan shaft assembly • To fit all 3950, 3955, 3970 & 3975 harvesters • Also will fit all 3940 and 3960 harvesters by ordering splined hub part #K64778 below • 90 lbs.	AE41606 AFH205972
K64778 \$140.00 ea.	③ • Splined fan drive hub • 4.1 lbs. • To fit all 3950, 3955, 3970 & 3975 harvesters • Bolt kit: K64778BK , \$4.50 ea., .5 lbs. • Also to fit 3940 and 3960 harvesters updated to tapered spline fan shaft	E64778 FH312522
K37844 \$21.80 ea.	④ • Fan paddle • To fit 3940, 3950, 3955, 3960, 3970 & 3975 harvesters • 4 required • 3.9 lbs.	AE37844 Abrasion Resistant
K33650BK \$12.85 ea.	⑤ • Bolt kit for fan paddles • One kit contains enough bolts and nuts for 4 paddles • 2 lbs.	
K37341P \$46.85 ea.	⑥ • Fan drive idler pulley • To fit all 3000 series harvesters • 2 required • 2.2 lbs.	AE37341 AFH205878



KOOIMA #	DESCRIPTION	REPLACES OEM #
K45990 \$145.75 ea.	⑦ • Inside fan sheet • To fit 3940, 3950, 3955, 3960, 3970 & 3975 harvesters • 44 lbs. • Hardware kit: K45990BK , \$65.45 ea.	AE45990 Abrasion Resistant
K37290 \$120.75 ea.	⑧ • Outside fan sheet • To fit 3940, 3950, 3955, 3960, 3970 & 3975 harvesters • 36.3 lbs. • Hardware kit: K37290BK , \$38.85 ea.	AE37290/AFH205900 Abrasion Resistant
K36535 \$99.45 ea.	⑨ • Front blower band • To fit all 3000 series harvesters • Newer heavy duty style • 3/16" thick material • 22.8 lbs. • One of the most durable blower bands on the market	AE36535 Abrasion Resistant
K78174 \$135.00 ea.	⑩ • Rear blower band • To fit all 3000 series harvesters • Newer heavy duty style • 3/16" thick material • 28 lbs. • One of the most durable blower bands on the market	E78174 Abrasion Resistant
K62384 \$23.30 ea.	⑪ • Spout ring gear • Made of high carbon steel • 2.2 lbs. • To fit all 3000 series harvesters • 1 required without spout track • 2 required with spout track	E62384
K45967 \$20.30 ea.	⑫ • Outside fan sheet inspection doors • 2 required • To fit all 3000 series • 3.8 lbs. • Hardware kit: K45967BK , \$1.35 ea., .05 lbs.	AE45967 Abrasion Resistant

TO ORDER CALL TOLL FREE 1-800-522-8874

KOOIMA® REPLACEMENT PARTS TO FIT 3000 SERIES JOHN DEERE® FORAGE HARVESTERS

Replacement parts produced by Kooima® Company to fit JD® 3000 Series

KOOIMA #
K22358

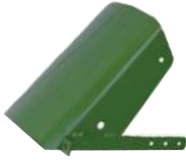

\$49.35 ea.

DESCRIPTION

- Spout deflector
- To fit all 3000 series harvesters equipped with John Deere® factory spout
- 4.1 lbs.

REPLACES OEM #
AFH205884 / AE22358
Abrasion Resistant

K38647SP



\$195.75 ea.

- Double spout deflector assembly
- To fit 3000 series harvesters equipped with Kooima® spout assembly
- Allows precise control of feed flow & more complete filling of your trucks or wagons
- 20.1 lbs.

Abrasion Resistant

K52447
K52448



\$63.00 ea.

- Left hand spout liner
- Right hand spout liner
- To fit all 3000 series harvesters equipped with John Deere® factory spout
- 7.4 lbs. ea.
- Hardware Kit: K52447BK, \$12.25, .62 lbs.

FH312296 / E52447
FH312290 / E52448
Abrasion Resistant

K76994



\$92.50 ea.

- Center spout liner
- To fit all 3000 series harvesters equipped with John Deere® factory spout
- 16.7 lbs.
- Hardware Kit: K76994BK, \$4.75

FH312199/E76994
Abrasion Resistant

High Quality Silage Covers

We also carry 6 mil and 8 mil reinforced string tarps, for more information on these go to the front inside cover.



Detail of reinforced string tarps

Prices are subject to change.

Standard Silage Tarps White/Black - 5.0 mil (A5WB1)

Part #	Price	W X L	Weight
K57442	\$108.00	24 X 100	69 lbs.
K57443	\$144.00	32 X 100	90 lbs.
K57628	\$216.00	32 X 150	133 lbs.
K46534	\$180.00	40 X 100	110 lbs.
K57574	\$270.00	40 X 150	163 lbs.
K57575	\$360.00	40 X 200	216 lbs.
K50158	\$225.00	50 X 100	138 lbs.
K50159	\$337.50	50 X 150	203 lbs.
K54235	\$450.00	50 X 200	299 lbs.
K57576	\$270.00	60 X 100	161 lbs.
K53942	\$405.00	60 X 150	255 lbs.
K57577	\$540.00	60 X 200	346 lbs.
K64369	\$2,100.60	60 X 1000	1,557 lbs.
K69881	\$540.00	80 X 150	325 lbs.
K69880	\$720.00	80 X 200	455 lbs.
K70463	\$900.00	80 X 250	561 lbs.
K77059	\$2,800.80	80 X 1000	1,999 lbs.

*** Free shipping on Silage Covers if combined with \$750 in Kooima® parts on phone and internet orders**

KOOIMA® REPLACEMENT PARTS TO FIT 3000 SERIES JOHN DEERE® FORAGE HARVESTERS

Replacement parts produced by Kooima® Company to fit JD® 3000 Series

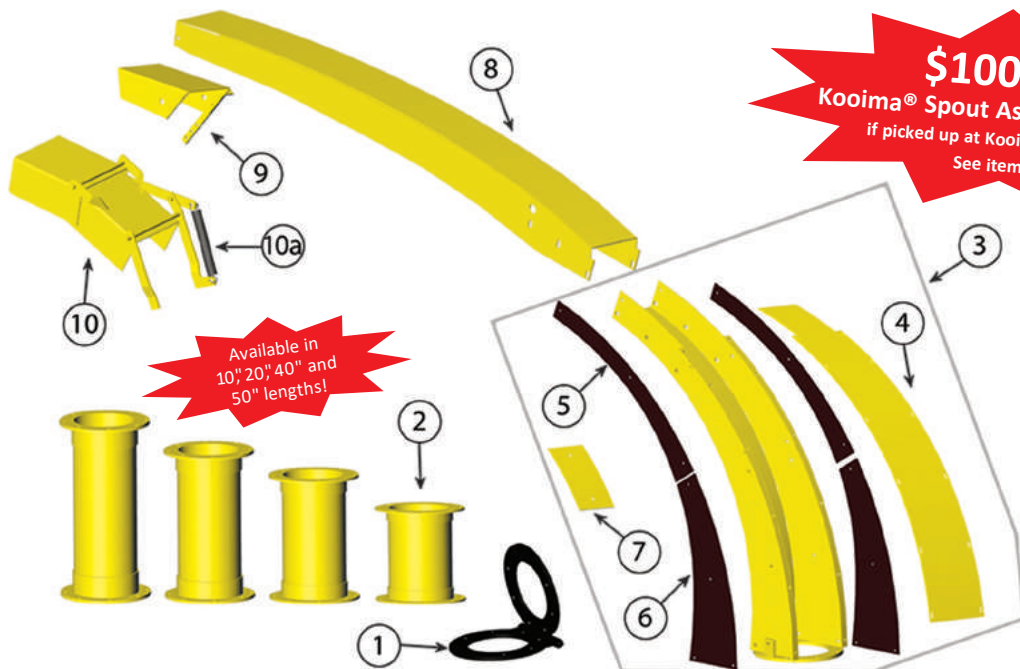

KOOIMA #	DESCRIPTION	REPLACES OEM #
K79396 \$13.80 ea.	• Spout deflector spring • .3 lbs. • To fit all Kooima® and John Deere® spouts	E79396
K50000 \$190.75 ea.	① • Spout hinge kit • To fit all 3000 series harvesters • Allows you to fold the spout down for transport or low clearance storage • Mounting hardware included • 27.6 lbs.	
K37336 \$250.75 ea.	② • 10" spout extension • 29.3 lbs. • To fit all 3000 series harvesters • Bolt kit: K37336BK, \$23.80 ea., 1.2 lbs.	AE37336
K37337 \$300.80 ea.	②a • 20" spout extension • 38 lbs. • To fit all 3000 series harvesters • Bolt kit: K37336BK, \$23.80 ea., 1.2 lbs.	AE37337
K37338 \$325.80 ea.	②b • 40" spout extension • 55 lbs. • To fit all 3000 series harvesters • Bolt kit: K37336BK, \$23.80 ea., 1.2 lbs.	AE37338
K37339 \$410.80 ea.	②c • 50" spout extension • To fit all 3000 series harvesters • 65.5 lbs. • This is a must when top loading trucks in rough terrain • Bolt kit: K37336BK, \$23.80 ea., 1.2 lbs. *All Kooima® spout extensions are reinforced, top and bottom, for added strength.	
K37331 \$750.00 ea.	③ • Lower spout assembly • Includes wear plates listed below • 111 lbs. • To fit all 3000 series harvesters • Does NOT fit with John Deere® upper spout assembly • Easy to replace bolt-in wear plates make repairs a snap! Kooima® spout assemblies feature an exclusive enclosed design for superior performance in all crops, including hard-to-blow dry hay. Replaceable abrasion resistant wear plates make this the most durable spout available.	AE37331
K37340 \$120.75 ea.	④ • Rear spout cover • 28 lbs.	Abrasion Resistant
K37341 \$40.35 ea.	⑤ • Top inside wear plates • 2 required • 3.2 lbs.	Abrasion Resistant
K37342 \$40.35 ea.	⑥ • Bottom inside wear plate • 2 required • 6 lbs.	Abrasion Resistant
K37343 \$20.30 ea.	⑦ • Inspection cover door • 2.5 lbs.	Abrasion Resistant
K37333 \$170.75 ea.	⑧ • Outer spout extension • 30" long • To fit all 3000 series using Kooima® lower spout assembly • 31 lbs.	AE37333/AFH205982 Abrasion Resistant
K38645BK \$5.25 ea.	⑧a • Upper spout extension bolt kit • Use with 30" or 54" extension • 1.25 lbs.	
K38647 \$57.85 ea.	⑨ • Spout deflector • To fit all 3000 series using Kooima® spout assembly • 8.5 lbs.	Abrasion Resistant
K38647BK \$3.75 ea.	⑨a • Spout deflector bolt kit • .2 lbs.	
K38647SP \$195.75 ea.	⑩ • Double spout deflector assembly • Allows precise control of feed flow & more complete filling of your truck or wagons • Comes with a spring • To fit all 3000 series using Kooima® spout assembly • 20.1 lbs.	Abrasion Resistant
FH001303 \$12.75 ea.	⑩a • Replacement spring for double deflector • .9 lbs.	

Truck icon signifies product is shipped via truck freight.













Order online at WWW.KOOIMA.COM and receive FREE FREIGHT to your door!

KOOIMA®
COMPANY



KOOIMA® REPLACEMENT PARTS TO FIT 34, 35, 38, & 3800 JOHN DEERE® FORAGE HARVESTERS

Replacement parts produced by Kooima® Company to fit JD® 34, 35, 38 & 3800

KOOIMA #		DESCRIPTION	REPLACES OEM #
K36831		<ul style="list-style-type: none"> • Knife • To fit 34 harvesters • 8.6 lbs. 	E36831 Heat Treated Tungsten Carbide
K36831BK		<ul style="list-style-type: none"> • Bolt Kit for K36831 • 1.65 lbs. 	B3627R/19H2411/E33457
K53084		<ul style="list-style-type: none"> • Shearbar • 8.6 lbs. • To fit 34 harvesters • Bolt kit: K53084BK, \$7.65 ea. .65 lbs. 	E53084 Heat Treated Tungsten Carbide
K33321		<ul style="list-style-type: none"> • Knife • 7.3 lbs. • To fit 35 & 38 harvesters • Bolt kit: K33321BK, \$33.35 ea., 1.95 lbs. 	E33221 Heat Treated Tungsten Carbide
K53085		<ul style="list-style-type: none"> • Shearbar • 5.6 lbs. • To fit 35 & 38 harvesters • Bolt kit: K53085BK, \$32.35 ea. 	E53085 Heat Treated Tungsten Carbide
K62285		<ul style="list-style-type: none"> • Knife • To fit 3800 harvesters • 8.8 lbs. 	E62285 Heat Treated Tungsten Carbide
K56369		<ul style="list-style-type: none"> • Shearbar • To fit 3800 harvesters • 11.8 lbs. 	E56369 Heat Treated Tungsten Carbide
K56369BK		<ul style="list-style-type: none"> • Bolt Kit • To fit K56369 • .85 lbs. 	
K22635		<ul style="list-style-type: none"> • Sharpening stone • To fit 34, 35, 38 and 3800 harvesters • 2 lbs. 	AE22635
K32487		<ul style="list-style-type: none"> • Knife bolt • To fit all 3800 harvesters • .6 lbs. 	AE32487
K32291		<ul style="list-style-type: none"> • Front fan sheet • To fit 3800 harvesters • 40.6 lbs. 	AE32291 Abrasion Resistant
K36464		<ul style="list-style-type: none"> • Fan paddle • To fit 35, 38 & 3800 harvesters • 4 required • 1.8 lbs. • Bolt kit: K36464BK, \$3.75 ea. 	E36464 Abrasion Resistant

KOOIMA® REPLACEMENT PARTS TO FIT JOHN DEERE® 4-ROW CONVERGING CORN HEADS

Replacement parts produced by Kooima® Company to fit JD® Corn & Forage Heads

KOOIMA #		DESCRIPTION	REPLACES OEM #
K56587		<ul style="list-style-type: none"> Side knife To fit all 483, 484 stalker heads and 4-row forage heads • Counter-sunk holes • 1 lb. 	E56857 Tungsten Carbide Heat Treated
K63576		<ul style="list-style-type: none"> Fly knife To fit all 483, 484 stalker heads and 4-row forage heads • Counter-sunk holes • 1 lb. 	E63576 Tungsten Carbide Heat Treated
K34227		<ul style="list-style-type: none"> Nut and bolt assembly To fit all 483, 484 stalker heads and 4-row forage heads prior to SN. 680001 • 1/2" x 1-1/4" • .1 lbs. 	E34227 14H1040
K95793		<ul style="list-style-type: none"> Nut and bolt assembly To fit 4-row forage heads SN. 680001 and after, fly knife only • 1/2" x 1-3/4" • .15 lbs. 	14H1040 H168232
K64299		<ul style="list-style-type: none"> Row unit guard plate To fit John Deere® 4-row corn heads • 4 required • .7 lbs. • Hardware Kit: K64299BK, \$3.75, .19 lbs. 	FH304973 E64299
K40386		<ul style="list-style-type: none"> Row unit skid plate - inner rows To fit John Deere® 4-row corn heads • 4 required • 3.7 lbs. 	AE40386 Abrasion Resistant

Check out our Newly Redesigned website!

www.kooima.com



24/7 access to order!



Free shipping on retail web orders in the Continental U.S.!

(Some exclusions apply)



Watch videos of our products!

TO ORDER CALL TOLL FREE 1-800-522-8874

KOOIMA®
COMPANY



KOOIMA® REPLACEMENT PARTS TO FIT JOHN DEERE® CORN & FORAGE HEADS

Replacement parts produced by Kooima® Company to fit JD® Corn & Forage Heads

KOOIMA #		DESCRIPTION	REPLACES OEM #
K33368		<ul style="list-style-type: none"> • Side knife • 1 lb. • To fit 1-row and 2-row corn heads SN. 550000 and before • To fit 3-row corn heads SN. 490000 and before • Standard holes 	E33368 Heat Treated Tungsten Carbide
\$15.10 ea.			
K56587		<ul style="list-style-type: none"> • Side knife • 1 lb. • To fit 1-row and 2-row corn heads SN. 550001 & after • To fit 3-row corn heads SN. 490001 and after • Counter-sunk holes 	E56857 Heat Treated Tungsten Carbide
\$17.50 ea.			
K61278		<ul style="list-style-type: none"> • Fly knife • 1 lb. • To fit 1-row and 2-row corn heads SN. 550000 and before • To fit 3-row corn heads SN. 490000 and before • Counter-sunk holes 	E61278 Heat Treated Tungsten Carbide
\$26.25 ea.			
K63576		<ul style="list-style-type: none"> • Fly knife • 1 lb. • To fit 1-row and 2-row corn heads SN. 550001 and after • To fit 3-row corn heads SN. 490001 and after • Counter-sunk holes 	E63576 Heat Treated Tungsten Carbide
\$34.75 ea.			
K34227		<ul style="list-style-type: none"> • Nut and bolt assembly • .1 lbs. • To fit 1-row and 2-row corn heads SN. 550001 and after • To fit 3-row corn heads SN. 490001 and after • 1/2" x 1-1/4" 	E34227 14H1040
\$2.75 ea.			
K49269		<ul style="list-style-type: none"> • Knife drive pitman end • To fit 1, 2 & 3-row corn heads • 1 required per row • .65 lbs. 	AE49269 AE45212
\$24.75 ea.			
K34975		<ul style="list-style-type: none"> • Row unit guard plate • .7 lbs. • To fit 1 & 2 row corn heads SN. 550000 and before • To fit 3 row corn heads SN. 490000 and before • Hardware Kit: K34975BK, \$2.40, .1 lbs. 	E34975
\$11.00 ea.			
K64299		<ul style="list-style-type: none"> • Row unit guard plate • .7 lbs. • To fit 1 & 2 row corn heads SN. 550001 and after • To fit 3 row corn heads SN. 490001 and after • Hardware Kit: K64299BK, \$3.75, .19 lbs. 	FH304973 E64299
\$13.55 ea.			

KOOIMA® REPLACEMENT PARTS TO FIT JOHN DEERE® CORN & FORAGE HEADS

Replacement parts produced by Kooima® Company to fit JD® Corn & Forage Heads

<u>KOOIMA #</u>	<u>DESCRIPTION</u>	<u>REPLACES OEM #</u>
K27079 \$135.00 ea.	<ul style="list-style-type: none"> Gathering chain To fit JD® 1-row and 2-row corn heads Requires 2 for the 1-row head and 4 for the 2-row head • 12.88 lbs. <p>* Now with improved heavier belting</p>	AE27079/AE73755
K33340 \$210.00 ea.	<ul style="list-style-type: none"> Outer gathering chain To fit JD® 3-row heads Has 155 links and 26 lugs • 20.88 lbs. Requires 2 for the 30" and 4 for the 38" <p>* Now with improved heavier belting</p>	AE73758/AE33340
K33341 \$183.00 ea.	<ul style="list-style-type: none"> Inner gathering chain To fit JD® 3-row heads Has 144 links and 24 lugs Requires 2 for the 30" • 19.28 lbs. <p>* Now with improved heavier belting</p>	AE73757/AE33341
K33342 \$169.00 ea.	<ul style="list-style-type: none"> Center gathering chain To fit JD® 3-row heads Has 119 links and 20 lugs Requires 2 for the 30" or 38" • 16.17 lbs. <p>* Now with improved heavier belting</p>	AE33342/AE73756
K27407 \$37.15 ea.	<ul style="list-style-type: none"> 17 tooth gathering chain drive sprocket 2 required per 1-row head 4 required per 2-row head 2 required per 3-row head for inner gathering chain drive • 1.9 lbs. 	AE27407/AFH205829 Heat Treated
K27930 \$79.00 ea.	<ul style="list-style-type: none"> 17 tooth gathering chain idler sprocket 2 required per 1-row head 4 required per 2-row head • 2.5 lbs. 	AE27930/AFH205827 Heat Treated
K27909 \$21.80 ea.	<ul style="list-style-type: none"> 15 tooth gathering chain idler sprocket Optional with #K27930 .9 lbs. 	AFH205780/AE27909 Heat Treated
K31154 \$42.00 ea.	<ul style="list-style-type: none"> 17 tooth gathering chain drive sprocket 2 required per 3-row head for center gathering chains • 2.2 lbs. 	AFH205933/AE31154 Heat Treated
K31155 \$46.10 ea.	<ul style="list-style-type: none"> 17 tooth outer gathering chain drive sprocket 2 required per 3-row head 2.9 lbs. 	AFH205978/AE31155 Heat Treated
K32504 \$40.10 ea.	<ul style="list-style-type: none"> 17 tooth idler sprocket 6 required per 3-row head 1.7 lbs. 	AFH205818/AE32504 Heat Treated



KOOIMA® REPLACEMENT PARTS TO FIT JOHN DEERE® 4-ROW CONVERGING CORN HEADS

Replacement parts produced by Kooima® Company to fit JD® Corn, Stalker & Forage Heads

4-ROW HEAD SCHEMATIC

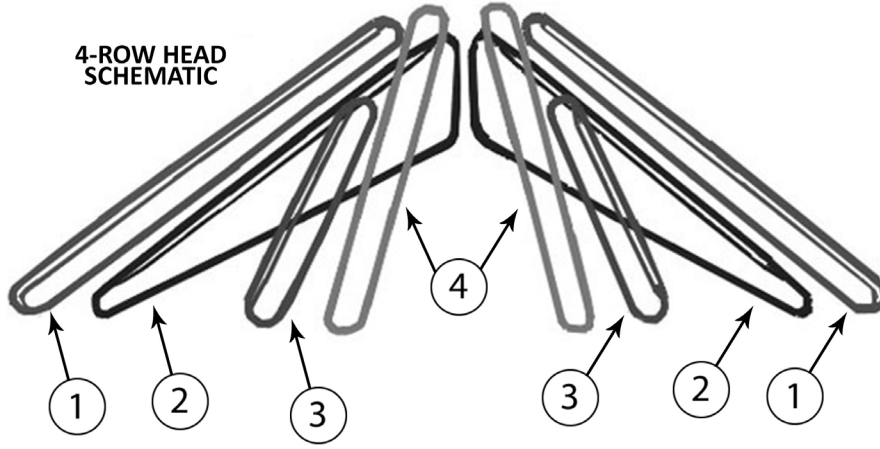

KOOIMA #
K44155

①

\$315.00 ea.



DESCRIPTION

- Gathering belt assembly
- To fit 4-row forage heads
- Has 108 links and 27 lugs • 2 required
- * Now with improved heavier belting**
- 24.9 lbs.

REPLACES OEM #

AE44155

K44156

②

\$325.00 ea.



- Gathering belt assembly
- To fit 4-row forage heads
- Has 112 links and 28 lugs • 2 required
- * Now with improved heavier belting**
- 25.8 lbs.

AE44156

K44151

③

\$180.00 ea.



- Gathering belt assembly
- To fit 4-row forage heads
- Has 64 links and 16 lugs • 2 required
- * Now with improved heavier belting**
- 14.8 lbs.

AE44151

K44152

④

\$265.00 ea.



- Gathering belt assembly
- To fit 4-row forage heads
- Has 88 links and 22 lugs • 2 required
- * Now with improved heavier belting**
- 20.3 lbs.

AE44152

K43675

\$77.00 ea.



- Lower gathering chain idler sprocket
- To fit John Deere® 4-row converging heads
- 10 required • 3.6 lbs.

AE45167

AE43675

K45166

\$72.00 ea.



- Upper gathering chain drive sprocket
- To fit John Deere® 4-row converging heads
- 8 required • 3.4 lbs.

AE46075

AE45166

K49269

\$24.75 ea.



- Knife drive pitman end
- To fit John Deere® 1, 2, 3 & 4-row converging corn heads
- 6 required on 4-row
- .65 lbs.

AE49269

AE45212

KOOIMA® REPLACEMENT PARTS TO FIT JOHN DEERE® 664 & 666 ROW CROP HEADS

Replacement parts produced by Kooima® Company to fit JD® Corn, Stalker & Forage Heads

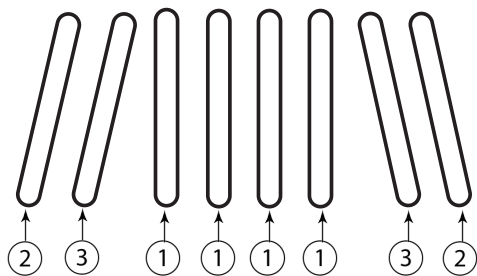

664
(4 row)

665R
(5 row)

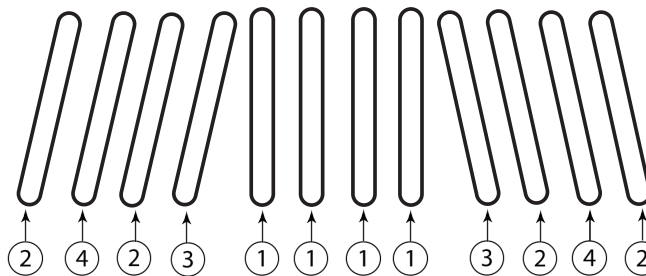

666
(6 row)

666R
(6 row)

KOOIMA #
K51762

①

\$104.00 ea.



DESCRIPTION

- Gathering chain assembly
- 48 links • 14.7 lbs.
- 4 required to fit John Deere® 664, 665R and 666 corn heads
- 6 required to fit John Deere® 666R corn heads

REPLACES OEM #
AZ51762

K51763

②

\$119.00 ea.

- Gathering chain assembly
- 50 links
- 2 required to fit John Deere® 664, 666R corn heads
- 4 required to fit John Deere® 665R and 666 corn heads • 15.4 lbs.

AZ51763

K51764

③

\$119.00 ea.

- Gathering chain assembly
- 52 links
- 2 required to fit John Deere® 664 corn heads
- 2 required to fit John Deere® 666 and 666R corn heads • 16 lbs.

AZ51764

K51765

④

\$129.00 ea.

- Gathering chain assembly
- 54 links
- 2 required to fit John Deere® 665R, 666 and 666R corn heads
- 16.6 lbs.

AZ51765

K9903150

\$160.00 ea.



- Row crop disc
- To fit John Deere® 664 4-row and 666 6-row forage heads • 4.9 lbs.

XQ9903150
Heat Treated Tungsten Carbide

K9120822

\$3.00 ea.



- Row crop disc scraper
- To fit John Deere® 664 4-row and 666 6-row forage heads
- .1 lbs. • **Hardware kit: K9120822BK, \$3.00 ea.**

XQ9120822
Heat Treated

Order # K46671-21

- PTO, 21 to 21 spline drive shaft
- To fit JD® 630-645B hay heads & 655R-666-666R row crop • 2400 series • 18.9 lbs.

\$390⁰⁰ ea.

Order # K46671-23

- PTO, 21 to 23 spline drive shaft
- To fit JD® 630-645B hay heads & 655R-666-666R row crop • 2400 series • 18.6 lbs.

\$390⁰⁰ ea.

REPLACEMENT PTO'S NOW AVAILABLE!



TO ORDER CALL TOLL FREE 1-800-522-8874

KOOIMA®
COMPANY



Kooima[®] Replacement Parts To Fit **KEMPER[™]**

KOOIMA[®] REPLACEMENT PARTS TO FIT KEMPER[™] CHAMPION[™] 3000 HEADS

Kemper[™] is a trademark of Maschinenfabrik KEMPER GmbH & Co., which does not manufacture, distribute or endorse these parts.

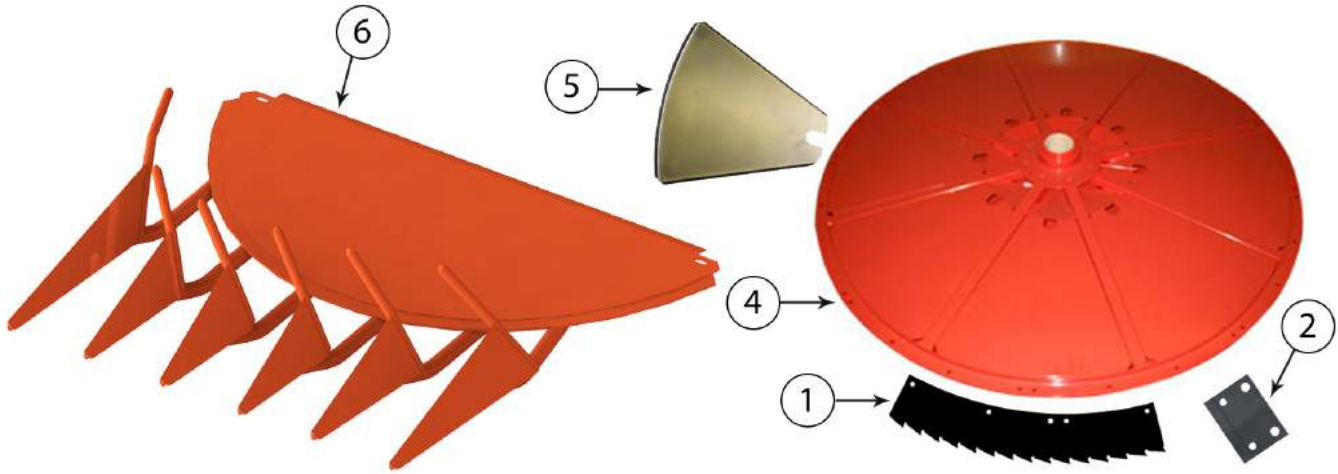

NOTE: When referring to Kemper[™] blades, right and left indicate the direction of rotation, **NOT** which side of the head it is on!

KOOIMA #	DESCRIPTION	REPLACES OEM #
KK66037	① • Cutting blade • To fit 3000 4-row heads • 16 required • 2.9 lbs.	LCA66037 Heat Treated High Carbon Material
KK55204	② • Blade scraper • To fit 3000 4-row • 4 required • .4 lbs.	LCA55204 Heat Treated Tungsten Carbide
KK3000BK	③ • Bolt kit • Metric bolt kit for cutting blades and scrapers • 1 kit required per head • 2.8 lbs.	
KK56992 (Right)	④ • Drum rotor • To fit 3000 4-row heads • 78.5 lbs. ea.	LCA56994 / LCA56992
KK56993 (Left)	④ • Drum rotor • To fit 3000 4-row heads • 78.5 lbs. ea.	LCA56995 / LCA56993
KK56726	⑤ • Weld-in drum rotor repair panel • To fit 3000 4-row heads • 8 required per rotor • 1.9 lbs.	LCA56726
KK53161 (Left)	⑥ • Replacement crop divider assembly • To fit 3000 4-row heads • Left hand shown • 126 lbs.	LCA53161
KK53162 (Right)	⑥ • Replacement crop divider assembly • To fit 3000 4-row heads • Right hand shown • 126 lbs.	LCA53162 Abrasion Resistant

(Also available with Tungsten Carbide - see pages 108 & 109)





KK48952		• Weld-on drum segment • To fit 3000 4-row • 24 required • 1.4 lbs.	LCA48952 Abrasion Resistant
---------	--	--	--------------------------------

KK49496		• Weld-on drum segment • To fit 3000 4-row • 24 required • 2.8 lbs.	LCA49496 Abrasion Resistant
---------	--	---	--------------------------------

Truck icon signifies product is shipped via truck freight.

KOOIMA® REPLACEMENT PARTS TO FIT KEMPER™ CHAMPION™ 3000 HEADS

Replacement parts produced by Kooima® Company to fit Kemper™ Champion™ 3000 Heads

KOOIMA #		DESCRIPTION	REPLACES OEM #
KK57911	 5 ^{15/16} " O.D.	<ul style="list-style-type: none"> • Clutch friction disc • To fit Kemper™ 3000 series 4-row and 4500 series 6-row main clutch • 8 required • .1 lbs. 	W34913
KK59046	 6 ^{3/16} " O.D.	<ul style="list-style-type: none"> • Clutch friction disc • To fit Kemper™ 4500 series 6-row, drum clutch • 16 required • .1 lbs. 	DC38275
KK51586		<ul style="list-style-type: none"> • Short gathering point guide rod • 10-1/2" long • Weld-in application • To fit Kemper™ 3000 series 4-row, Kemper™ 4500 & JD® 676 6-row • 14 required • 1.3 lbs. 	LCA51586
KK51587		<ul style="list-style-type: none"> • Long gathering point guide rod • 14" long • Weld-in application • To fit Kemper™ 3000 series 4-row, Kemper™ 4500 & JD® 676 6-row • 4 required • 1.8 lbs. 	LCA51587

HEAD CART



This SPFH friendly head cart will keep your expensive chopping and hay heads off the ground, while you enjoy the benefits of easy loading and unloading using your existing chopper. The 9000 lb. rated capacity and 15' base accommodate a large range of heads.

US Patent: 8,919,800
Order # KHC15
Call For Pricing

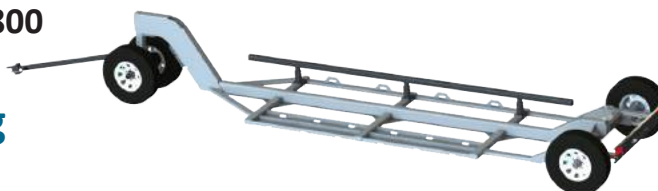

Optional Hitch Pin / Clevis Connection
Order # FH5001013
\$100⁷⁵ ea.
 8.35 lbs.



Order online at WWW.KOOIMA.COM and receive **FREE FREIGHT** to your door!

KOOIMA®
 COMPANY



KOOIMA® COMPANY'S NEWEST INNOVATION IN REPLACING KEMPER™ BLADES!

Replacement blades produced by Kooima® Company to replace Kemper™ blades

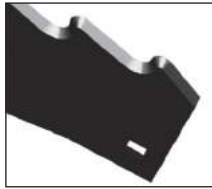

Kooima® Company has incorporated the best attributes of the Claas® RU series cutting blade into a new product that will replace Kemper™ blades. Our new line features a scalloped cutting surface milled to a sharp edge and then sprayed with tungsten carbide. The scalloped design substantially increases the amount of available cutting surface. The milled tungsten carbide edge pulls easily through the toughest crops and stays sharp for hours of trouble free service. ***Install tungsten carbide side up***

KOOIMA #
KK66035SPL
KK66035SPR



\$37.75 ea.

DESCRIPTION

- Left hand blade, small drum
- Right hand blade, small drum
- To fit JD® 676 and Kemper™ 4500 6-row heads
- **U.S. Patent # 7290341**
- **Australian Patent # 2005331255**
- **Canadian Patent # 2605690**
- Left hand shown • 2.9 lbs.

REPLACES OEM #

LCA66035
 LCA66036
Abrasion Resistant
Tungsten Carbide

KK66037SPL
KK66037SPR



\$37.75 ea.

- Left hand blade, large drum
- Right hand blade, large drum
- To fit Kemper™ 3000 4-row, JD® 676 & Kemper™ 4500 6-row heads, & JD® 678 8-row heads
- **U.S. Patent # 7290341**
- **Australian Patent # 2005331255**
- **Canadian Patent # 2605690**
- Left hand shown • 2.8 lbs.

LCA66037
 LCA66038
Abrasion Resistant
Tungsten Carbide

KK67746SPL
KK67746SPR



\$37.75 ea.

- Left hand blade
- Right hand blade
- To fit JD® 684 4-row, 686 6-row, 688 8-row, 710 10-row
- To fit Kemper™ 330 4-row, 345 6-row, 360 and 6008 8-row, 375 10-row
- **U.S. Patent # 7290341**
- **Canadian Patent # 2605690**
- **Australian Patent # 2005331255**
- Left hand shown • 2.1 lbs.

LCA67746
 LCA95957
Abrasion Resistant
Tungsten Carbide

FOR EASY ORDERING, USE THE CONVENIENT CHART BELOW:

Each kit includes full set of knives and full set of hardware

KOOIMA #	KIT PRICE	DESCRIPTION	KIT COMPONENTS
KK3000SP	\$633.30	Kemper™ 3000 4-row	(8) #KK66037SPL, (8) #KK66037SPR, (1) #KK3000BK, 50 lbs.
KK4500SP	\$941.35	Kemper™ 4500 & JD® 676 6-row	(4) #KK66035SPL, (4) #KK66035SPR, (8) #KK66037SPL, (8) #KK66037SPR, (1) #KK4500BK, 74.1 lbs.
KK330SP	\$672.45	Kemper™ 330 & JD® 684 4-row	(8) #KK67746SPL, (8) #KK67746SPR, (1) #KK6006BK, 44 lbs.
KK345SP	\$974.45	Kemper™ 345 & JD® 686 6-row	(12) #KK67746SPL, (12) #KK67746SPR, (1) #KK6006BK, 60 lbs.
KK360SP	\$1,298.45	Kemper™ 360, 6008 & JD® 688 8-row	(16) #KK67746SPL, (16) #KK67746SPR, (1) #KK6000BK, 78 lbs.
KK678SP	\$1,318.75	Kemper™ 678 & 778 Big Drum 8-row	(16) #KK66037SPL, (16) #KK66037SPR, (1) #KK678BK, 98 lbs.
KK375SP	\$1,600.45	Kemper™ 375 10-row, JD® 710 10-row	(20) #KK67746SPL, (20) #KK67746SPR, (1) #KK6000BK, 96 lbs.
KK770SP	\$1,641.75	Kemper™ 475 10-row, JD® 770 10-row	(16) #KK66037SPL, (16) #KK66037SPR, (4) #KK67746SPR, (4) #KK67746SPL, (1) #KK770BK
KK692SP	\$1,948.90	Kemper™ 390+ 12-row, JD® 692 12-row	(24) #KK67746SPL, (24) #KK67746SPR, (2) #KK6006BK

AT KOOIMA® COMPANY, WE LISTEN!

After meeting with many of our customers and listening to their requests, Kooima® Company is offering left and right hand replacement Kemper™ blades with Tungsten Carbide on the top cutting surface. Tungsten Carbide on the top increases the serviceable life of the blade, saving you money! Once again, when you talk, Kooima® Company listens!

Install tungsten carbide side up

Left Hand Blades



KK66035LTC – \$36.50 ea. 2.95 lbs.
To fit: Kemper™ 4500, JD® 676 (small drum only)



KK66037LTC – \$36.50 ea. 2.8 lbs.
To fit: Kemper™ 3000 – 4 row, Kemper™ 4500, JD® 676 – 6 row, (large drum only)

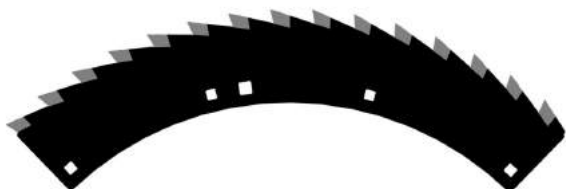

KK67746LTC – \$36.50 ea. 2 lbs.
To fit: JD® 684 4-row, 686 6-row, 688 8-row, 710 10-row
To fit: Kemper™ 330 4-row, 345 6-row, 360 and 6008 8-row, 375 10-row

Right Hand Blades



KK66035RTC – \$36.50 ea. 2.95 lbs.
To fit: Kemper™ 4500. JD® 676 (small drum only)

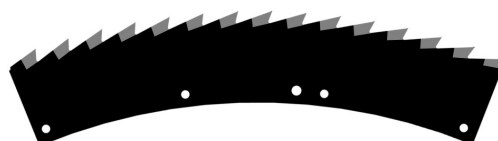

KK66037RTC – \$36.50 ea. 2.8 lbs.
To fit: Kemper™ 3000 – 4 row, Kemper™ 4500, JD® 676 6-row, (large drum only)

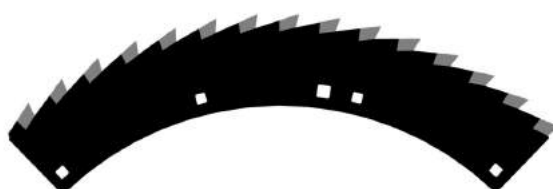

KK67746RTC – \$36.50 ea. 2 lbs.
To fit: JD® 684 4-row, 686 6-row, 688 8-row
To fit: Kemper™ 330 4-row, 345 6-row, 360 and 6008 8-row, 375 10-row

FOR EASY ORDERING, USE THE CONVENIENT CHART BELOW:

Each kit includes full set of knives and full set of hardware

<u>KOOIMA #</u>	<u>KIT PRICE</u>	<u>DESCRIPTION</u>	<u>KIT COMPONENTS</u>
KK3000TC	\$613.30	Kemper™ 3000 4-row	(8) #KK66037LTC, (8) #KK66037RTC, (1) #KK3000BK, 50 lbs.
KK676TC	\$911.35	Kemper™ 4500 & JD® 676 6-row	(4) #KK66035LTC, (4) #KK66035RTC, (8) #KK66037LTC, (8) #KK66037RTC, (1) #KK4500BK, 74.1 lbs.
KK330TC	\$652.45	Kemper™ 330 & JD® 684 4-row	(8) #KK67746LTC, (8) #KK67746RTC, (1) #KK6006BK, 44 lbs.
KK345TC	\$944.45	Kemper™ 345 & JD® 686 6-row	(12) #KK67746LTC, (12) #KK67746RTC, (1) #KK6006BK, 60 lbs.
KK360TC	\$1,258.45	Kemper™ 360, 6008 & JD® 688 8-row	(16) #KK67746LTC, (16) #KK67746RTC, (1) #KK6000BK, 78 lbs.
KK678TC	\$1,278.75	Kemper™ 678 & 778 Big Drum 8-row	(16) #KK66037LTC, (16) #KK66037RTC, (1) #KK678BK, 98 lbs.
KK375TC	\$1,550.45	Kemper™ 375 10-row, JD® 690 10-row JD® 710 10-row	(20) #KK67746LTC, (20) #KK67746RTC, (1) #KK6000BK, 96 lbs.
KK770TC	\$1,591.75	Kemper™ 475 10-row, JD® 770 10-row	(16) #KK66037LTC, (16) #KK66037RTC, (4) #KK67746RTC (4) #KK67746LTC, (1) #KK770BK
KK692TC	\$1,888.90	Kemper™ 390+ 12-row, JD® 692 12-row	(24) #KK67746LTC, (24) #KK67746RTC, (2) #KK6006BK

John Deere® and JD® are registered trademarks of Deere & Company • Kemper™ and Champion™ are trademarks of Maschinenfabrik KEMPER GmbH & Co.

TO ORDER CALL TOLL FREE 1-800-522-8874



KOOIMA® REPLACEMENT PARTS TO FIT KEMPER™ 4500 AND JOHN DEERE® 676 6-ROW HEADS

Replacement parts produced by Kooima® Company to fit Kemper™ 4500 & JD® 676 Heads

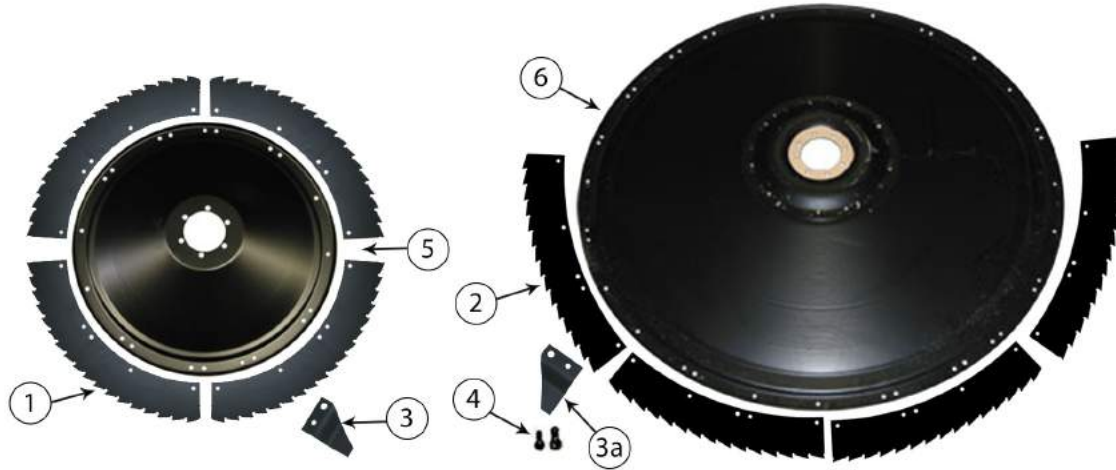

KOOIMA #	DESCRIPTION	REPLACES OEM #
KK66035 \$26.30 ea.	① • Cutting blade, small drum • To fit Champion™ 4500 & JD® 676 6-row heads • 4 required per drum • 2.9 lbs.	LCA66035 Heat Treated
KK66037 \$27.00 ea.	② • Cutting blade, large drum • To fit Champion™ 4500 & JD® 676 6-row heads • 8 required per drum • 2.8 lbs.	LCA66037 Heat Treated
KK67156 (Left) KK67157 (Right) \$10.75 ea.	③ • Blade scraper • .25 lbs. ea. ③a • To fit Champion™ 4500 & JD® 676 6-row heads ③a • 4 left and 4 right required • Use on thick blades	LCA67156 LCA67157 Heat Treated/Tungsten Carbide
KK4500BK \$35.35 ea.	④ • Bolt kit • Metric bolt kit to fit Kemper™ 4500 and JD® 676 6-row heads • 1 kit required per head • 4.1 lbs.	
KK64423 \$215.75 ea.	⑤ • Small drum rotor • To fit all Kemper™ 4500 and John Deere® 676 6-row heads • 2 required • 17.2 lbs.	LCA64423
KK66032 \$875.80 ea.	⑥ • Large drum rotor • To fit all Kemper™ 4500 and John Deere® 676 6-row heads • 2 required • 88.5 lbs.	LCA66032 LCA84838

(Also available with Tungsten Carbide - see pages 108 & 109)

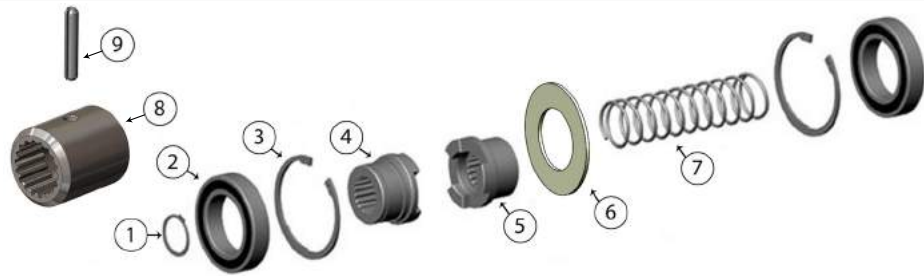

KOOIMA #	DESCRIPTION	REPLACES OEM #
KK05539 \$6.00 ea.	① • Small snap retaining ring • Holds outside wing drive coupler • .05 lbs.	LCA05539/LCA12228 40M7066/40M1841
KK64557 \$39.00 ea.	② • Bearing for wing drive coupler • 4 required • To fit Kemper™ 4500 and John Deere® 676 6-row heads • .85 lbs.	LCA64557 JD9241
KK05375 \$10.00 ea.	③ • Large snap retaining ring • Holds wing drive bearing • .1 lbs.	LCA05375 40M7060 / 40M1873
KK67316 \$51.75 ea.	④ • Outside wing drive coupler • To fit late Kemper™ 4500 and John Deere® 676 6-row heads • Has drilled and tapped hole for slide hammer removal • Head SN. 120 = 15 splines, 121 = 15 & 18 splines, 122 = 18 splines • 18 splines • 1 required • 1.1 lbs.	LCA67316
KK67317 \$51.75 ea.	⑤ • Inside wing drive coupler • To fit late Kemper™ 4500 and John Deere® 676 6-row heads • 1 required • 1.1 lbs.	LCA67317
KK62684 \$8.75 ea.	⑥ • Clutch disc • To fit John Deere® 676 and Kemper™ 4500 heads • 1 lb.	LCA62684
KK64574 \$17.05 ea.	⑦ • Compression spring • 2 required • .4 lbs.	LCA64574
KK67319 \$38.45 ea.	⑧ • Wing drive shaft coupler • 2 required • 1 lb. • To fit John Deere® 676 series and Kemper™ 4500 & 445 series	LCA67319
K7048 \$1.25 ea.	⑨ • Spring pin • To fit KK67319 coupler	34M7048

John Deere® and JD® are registered trademarks of Deere & Company • Kemper™ and Champion™ are trademarks of Maschinenfabrik KEMPER GmbH & Co. Truck icon signifies product is shipped via truck freight.

KOOIMA® REPLACEMENT PARTS TO FIT KEMPER™ 4500 AND JOHN DEERE® 676 6-ROW HEADS

Replacement parts produced by Kooima® Company to fit Kemper™ 4500 & JD® 676 Heads

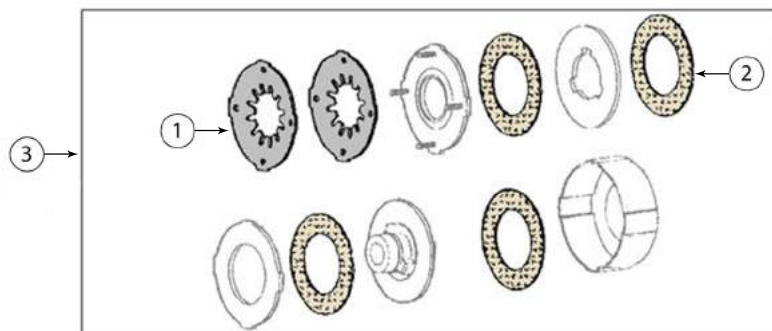

KOOIMA #	DESCRIPTION	REPLACES OEM #
KK67184 \$29.30 ea.	① • Spring plate • To fit main drive clutch on John Deere® 676 and Kemper™ 4500 heads • 2 required per clutch • .6 lbs.	LCA67184 Heat Treated
KK57911 \$19.50 ea.	② • Clutch friction disc • To fit Kemper™ 3000 series 4-row and 4500 series 6-row main clutch • 4 required per clutch • .1 lbs.	W34913
KK66024 \$870.00 ea.	③ • Main drive clutch assembly • Assembled & ready to install • To fit Kemper™ 4500 & JD® 676 6-row heads • 16.8 lbs.	LCA66024

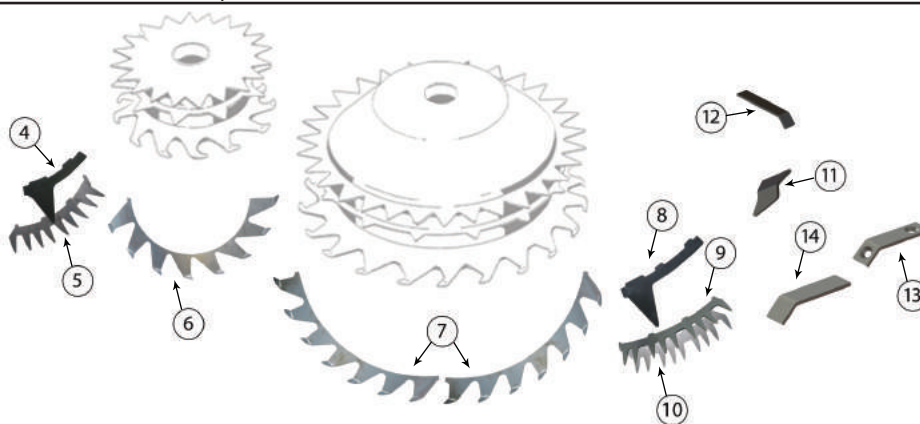

KOOIMA #	DESCRIPTION	REPLACES OEM #
KK67268 \$16.05 ea.	④ • Weld-on drum segment • To fit small feed drums on Kemper™ 4500 & John Deere® 676 6-row heads • 16 required • .7 lbs.	LCA67268
KK65704 \$16.80 ea.	⑤ • Weld-on drum segment • To fit small feed drums on Kemper™ 4500 & John Deere® 676 6-row heads • 10 required • 2.2 lbs.	LCA65704
KK65721LT (Left) KK65721RT (Right) \$63.45 ea.	⑥ • Weld-on drum segment • Repairs the bottom ring of teeth on Kemper™ 4500 & John Deere® 676 small drum • 2 required per drum • Left hand shown • 8 lbs. ea.	Abrasion Resistant
KK65723LT (Left) KK65723RT (Right) \$81.45 ea.	⑦ • Weld-on drum segment • Repairs the bottom ring of teeth on Kemper™ 4500 & John Deere® 676 large drum • 4 required per drum • Left hand shown • 8.8 lbs. ea.	Abrasion Resistant
KK67265 \$12.75 ea.	⑧ • Weld-on drum segment • To fit large feed drums on John Deere® 676 6-row heads • 14 required • 1.5 lbs.	LCA67265
KK65734 \$16.55 ea.	⑨ • Weld-on drum segment • To fit large feed drums on Kemper™ 4500 & John Deere® 676 6-row heads • 18 required • 2 lbs.	LCA65734
KK65732 \$16.55 ea.	⑩ • Weld-on drum segment • To fit large feed drums on Kemper™ 4500 6-row heads • 18 required • 3.2 lbs.	LCA65732
KK90654 (Clockwise - RH) KK90655 (Counterclockwise - LH) \$4.25 ea.	⑪ • Intake disc weld-on sections • Note: do not weld on the leading edge of point • To fit all the Kemper™ heads 330, 345, 375, 6008, 4500, 676, 445, 460, 475 • 12 required for small drum, 24 required for large drum • .15 lbs.	LCA90654 LCA90655 Abrasion Resistant
KK69794 \$5.25 ea.	⑫ • Large drum scraper • 2 required per drum • .25 lbs. • Note: do not weld on the leading edge of scraper	LCA69794 Abrasion Resistant
KK87284 \$9.25 ea.	⑬ • Bolt on scraper small drum • .2 lbs. • To fit JD® 684-710 & Kemper™ 330-375 • 2 required per drum	LCA87284 Abrasion Resistant
KK87284BK \$3.25 ea.	⑬a • Bolt kit • To fit scraper KK87284 • 1 kit required per scraper • .1 lbs.	
KK71242 \$5.25 ea.	⑭ • Weld on scraper small drum • 2 required per drum • .2 lbs.	LCA71242 Abrasion Resistant

John Deere® and JD® are registered trademarks of Deere & Company • Kemper™ and Champion™ are trademarks of Maschinenfabrik KEMPER GmbH & Co.

Order online at WWW.KOOIMA.COM and receive **FREE FREIGHT** to your door!

KOOIMA
COMPANY



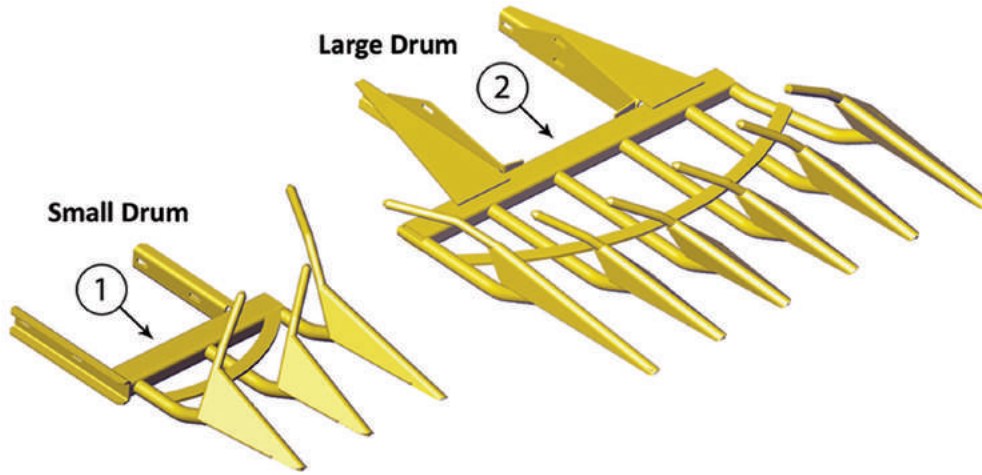

KOOIMA® REPLACEMENT PARTS TO FIT KEMPER™ 4500 AND JOHN DEERE® 676 6-ROW HEADS

Replacement parts produced by Kooima® Company to fit Kemper™ 4500 & JD® 676 Heads



KOOIMA #	DESCRIPTION	REPLACES OEM #
KK65048 (Left) KK65049 (Right) \$370.00 ea.	① • Replacement small drum crop divider assembly • 1 each required • Left hand shown • 32.8 lbs. ea. • Hardware Kit: KK65048BK , \$6.25 ea., .55 lbs.	LCA65048 LCA65049 Abrasion Resistant
KK64141 (Left) KK64142 (Right) \$670.00 ea.	② • Replacement large drum crop divider assembly • 1 each required • Left hand shown • 120 lbs. ea.  • Hardware Kit: KK64141BK , \$6.25 ea., .45 lbs.	LCA64141 LCA64142 Abrasion Resistant

KOOIMA #	DESCRIPTION	REPLACES OEM #
KK57911 \$19.50 ea.	 5 ^{15/16} " O.D. • Clutch friction disc • To fit Kemper™ 3000 series 4-row and 4500 series 6-row main clutch • 8 required • .1 lbs.	W34913

KK59046 \$27.50 ea.	 6 ^{3/16} " O.D. • Clutch friction disc • To fit Kemper™ 4500 series 6-row, drum clutch • 16 required • .1 lbs.	DC38275
-------------------------------	---	---------



The Rock Stop'er Pro

FORAGE HARVESTER STONE DETECTION SYSTEM



JD® must have double spring kit installed.

- Fits most makes and models of SPFH and pull type harvesters.
- Patented Inertia sensor stops feed drive when rocks are detected.
- In cab sensitivity adjustment for varying crop conditions.
- Call **1-800-522-8874** for more details!



1 lb.

Extra Sensor Available!

Order # SENSOR
Only **\$750⁸⁰** ea.

Order # ROCK STOPER
Only **\$2,950⁰⁰** ea.



Designed and manufactured in Canada.

John Deere® and JD® are registered trademarks of Deere & Company • Kemper™ and Champion™ are trademarks of Maschinenfabrik KEMPER GmbH & Co. Truck icon signifies product is shipped via truck freight.

FREE FREIGHT ON RETAIL ORDERS OVER \$750.00!

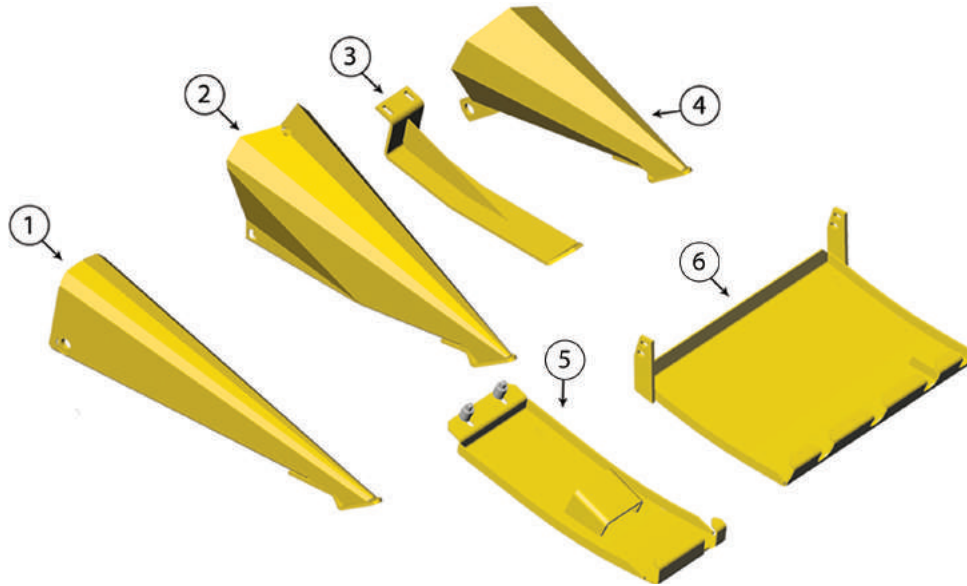

<u>KOOIMA #</u>	<u>DESCRIPTION</u>	<u>REPLACES OEM #</u>
KK67274 \$130.75 ea.	① • Outside center frame crop divider snoot • 2 each required • 18.1 lbs. • Hardware Kit: KK67274BK, \$15.30 ea.	LCA67274
KK68939 \$165.75 ea.	② • Center crop divider snoot • 1 each required • 15.6 lbs. • Hardware Kit: KK68939BK, \$3.75 ea., .2 lbs.	LCA68939 LCA68922
KK64910 \$40.35 ea.	③ • Crop divider skid plate • 2 each required • 9.7 lbs. • Now hard-faced for extra durability! • Hardware Kit: KK64910BK, \$20.80 ea.	LCA64910 Abrasion Resistant
KK67550 (Left) KK67551 (Right) \$125.00 ea.	④ • Wing crop divider snoot • To fit early 678 heads • 1 each required • 12.3 lbs. ea. • Left hand shown • Hardware kit - KK67550BK, \$17.05 ea. when used on large drum rotary heads	LCA67550 LCA67551
KK71879 (Left) KK71880 (Right) \$135.75 ea.	⑤ • Center frame skid plate • 1 each required • Left hand shown • 19.4 lbs. ea.	LCA71879 / LCA93840 LCA71880 / LCA93840 Abrasion Resistant
KK65111 (Left) KK65112 (Right) \$225.75 ea.	⑥ • Wing skid plate • Left hand shown • 1 each required • 31 lbs. ea. • Hardware Kit: KK65111BK, \$6.25 ea., .55 lbs.	LCA65111 / LCA92270 LCA65112 / LCA92270 Abrasion Resistant

REPLACEMENT PTO'S NOW AVAILABLE



Order # KK69888

- PTO, 21 to 21 spline
- To fit JD® 684-686-688 & 710 corn heads • 17.7 lbs.
- Replaces OEM # LCA69888

\$440⁰⁰ ea.

Order # KK72281

- PTO, 21 to 23 spline
- To fit JD® 684-686-688 & 710 corn heads • 18.8 lbs.
- Replaces OEM # LCA72281

\$440⁰⁰ ea.

Order # KK73023-23

- Drive Line
- 23 to 21 spline
- To fit JD® 676 corn heads • 15.8 lbs.

\$440⁰⁰ ea.

Order # KK73023-21

- Drive Line
- 21 to 21 spline
- To fit JD® 676 corn heads • 15.9 lbs.

\$440⁰⁰ ea.

Order # K64231

- PTO, 1 3/8 6 spline to 1 3/8 21 spline chopper
- To fit 6010 series cutters to 4500 Kemper™ heads
- 2400 series • 16 lbs.

\$440⁰⁰ ea.

Order # K72150

- PTO, 1 3/8 6 spline to 1 1/2 23 spline chopper
- To fit 6050 & 7000 series cutters to 4500 Kemper™ heads • 2400 series • 15.7 lbs.

\$440⁰⁰ ea.

Order # K46671-21

- PTO, 21 to 21 spline drive shaft • 18.9 lbs.
- To fit JD® 630-645B hay heads & 655R-666-666R row crop • 2400 series

\$390⁰⁰ ea.

Order # K46671-23

- PTO, 21 to 23 spline drive shaft • 18.6 lbs.
- To fit JD® 630-645B hay heads & 655R-666-666R row crop • 2400 series









\$390⁰⁰ ea.

TO ORDER CALL TOLL FREE 1-800-522-8874



KOOIMA® REPLACEMENT PARTS TO FIT KEMPER™ 4500 AND JOHN DEERE® 676 6-ROW HEADS

Replacement parts produced by Kooima® Company to fit Kemper™ 4500 & JD® 676 Heads

KOOIMA #		DESCRIPTION	REPLACES OEM #
KK67170 (Left) KK67171 (Right)		<ul style="list-style-type: none"> Feeding drum scraper To fit all Kemper™ 4500 and John Deere® 676 6-row heads 1 each required Left hand shown 24 lbs. ea. 	LCA67170 LCA67171 Abrasion Resistant
KK65858 (Left) KK65859 (Right)		<ul style="list-style-type: none"> Large drum scraper To fit all Kemper™ 4500 and John Deere® 676 6-row heads 1 each required Left hand shown • 24.6 lbs. ea. 	LCA65858 LCA65859 Abrasion Resistant
KK65841 (Left) KK65842 (Right)		<ul style="list-style-type: none"> Small drum crop guide To fit all Kemper™ 4500 and John Deere® 676 6-row heads 1 each required • Left hand shown • 7.3 lbs. ea. Hardware Kit: KK65841BK, \$14.80 ea., .51 lbs. 	LCA65841 LCA65842 Abrasion Resistant
KK66200 (Left) KK66201 (Right)		<ul style="list-style-type: none"> Large drum scraper To fit all Kemper™ 4500 and John Deere® 676 6-row heads 1 each required • Left hand shown • 14.3 lbs. ea. Hardware Kit: KK66200BK, \$6.25 ea., .395 lbs. 	LCA66200 LCA66201 Abrasion Resistant
KK64618 (Left) KK64619 (Right)		<ul style="list-style-type: none"> Support To fit all Kemper™ 4500 and John Deere® 676 6-row heads 1 each required • Left hand shown • 28 lbs. ea. Hardware Kit: KK64618BK, \$8.25 ea., .83 lbs. 	LCA64618 LCA64619 Abrasion Resistant
KK67530 (Left) KK67531 (Right)		<ul style="list-style-type: none"> Feeding drum crop guide To fit all Kemper™ 4500 and John Deere® 676 6-row heads 1 each required • Left hand shown • 23 lbs. ea. Hardware Kit: KK67530BK, \$11.00 ea., .595 lbs. 	LCA67530 LCA67531 Abrasion Resistant
KK67140 (Left) KK67139 (Right)		<ul style="list-style-type: none"> Feed roll intake drum assembly To fit all Kemper™ 4500 and John Deere® 676 6-row heads 1 each required Left hand shown 93.5 lbs. ea.  	LCA67140 LCA67139 Abrasion Resistant

KOOIMA® TOOL TO USE ON KEMPER™ HEADS



This handy tool makes Kemper™ head maintenance a snap!

Use it to:

- Re-align bent gather points and gathering point guide rods
- Straighten bent gathering drum teeth
- Stop using crescent or pipe wrenches and **save** your scraped knuckles!
- 9.3 lbs.

Order # **KK4500CB**

\$80⁴⁵ ea.

John Deere® and JD® are registered trademarks of Deere & Company • Kemper™ is a trademark of Maschinenfabrik KEMPER GmbH & Co. Truck icon signifies product is shipped via truck freight.

TO ORDER BY FAX CALL 1-712-476-6283

KOOIMA® REPLACEMENT PARTS TO FIT KEMPER™ 678 LARGE DRUM ROTARY HEADS

Replacement parts produced by Kooima® Company to fit Kemper™ 678 Large Drum Rotary Heads

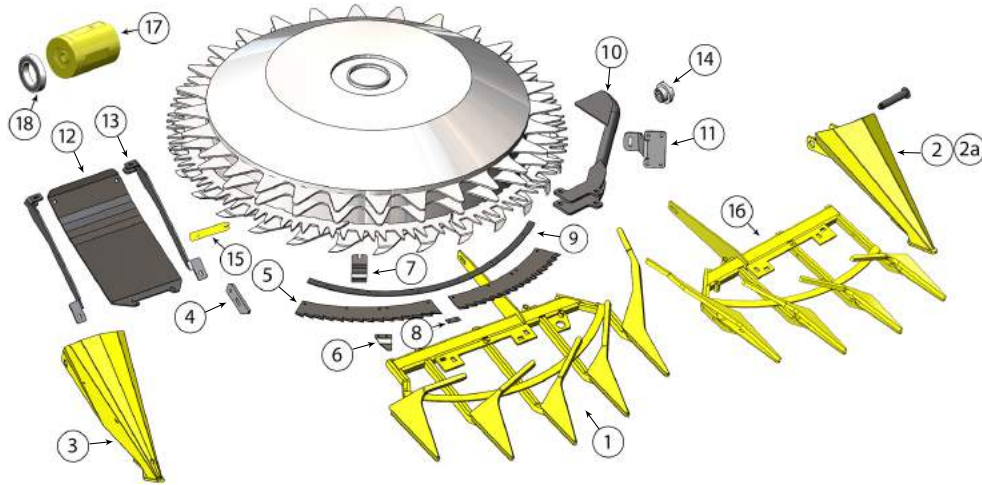

KOOIMA		DESCRIPTION	REPLACES OEM #
KK97977 (Left) KK97978 (Right) \$660.00 ea.	①	<ul style="list-style-type: none"> Inner large drum crop divider assembly To fit 678, 460, 475, 770, 460+, 778, 475+, 770+ & NH600 corn heads Left hand shown 	LCA97977 LCA97978
KK67550 (Left) KK67551 (Right) \$125.00 ea.	②	<ul style="list-style-type: none"> Wing crop divider snoot • 12.3 lbs. ea. • Left hand shown 1 each required • To fit early 678 heads Hardware kit - KK67550BK, \$17.05 ea. when used on large drum rotary heads Hardware kit - KK95833BK, \$18.30 ea. when used on 678 heads - pin fastener & lock plate 	LCA67550 LCA67551
KK95833 (Left) KK95834 (Right) \$150.75 ea.	②a	<ul style="list-style-type: none"> Wing crop divider snoot • 15.5 lbs. To fit Kemper™ & John Deere® 678 & 460 rotary heads 1 each required • Hardware kit - KK95833BK, \$18.30 ea. 	LCA95833 LCA95834
KK76783 \$250.75 ea.	③	<ul style="list-style-type: none"> Center crop divider snoot • 1 required • Bolt kit - KK75945BK, \$8.85 ea. To fit Kemper™ & John Deere® 678 & 460 rotary heads • 15.8 lbs. 	LCA76783
KK76678 \$8.25 ea.	④	<ul style="list-style-type: none"> Center snoot gathering point strap To fit Kemper™ & John Deere® 678 & 460 rotary heads • 1 lb. 	LCA76678
KK66037LTC (Left) KK66037RTC (Right) \$36.50 ea.	⑤	<ul style="list-style-type: none"> Hard faced cutting blade To fit Kemper™ & John Deere® 678, 778 & 460 rotary heads 8 each required per drum • 2.8 lbs. 	
KK678BK \$110.75 ea.	⑤a	<ul style="list-style-type: none"> Hardware kit • 1 kit required per head To fit Kemper™ & John Deere® 678 & 460 heads • 7.8 lbs. 	
KK67156 (Left) KK67157 (Right) \$10.75 ea.	⑥	<ul style="list-style-type: none"> Blade scraper To fit Kemper™ & John Deere® 678, 778 & 460 rotary heads 4 each required • .25 lbs. ea. 	LCA67156 LCA67157
KK89846 \$16.80 ea.	⑦	<ul style="list-style-type: none"> Rotating scraper • .65 lbs. To fit Kemper™ & John Deere® 678 & 460 heads • 8 required 	Heat Treated / Tungsten Carbide LCA89846
KK88009 \$4.20 ea.	⑧	<ul style="list-style-type: none"> Support strap • 32 required To fit Kemper™ & John Deere® 678, 778 & 460 rotary heads • .05 lbs. 	LCA88009
KK89871SS \$26.80 ea.	⑨	<ul style="list-style-type: none"> Drum rotor support strap • 4 required per drum • 1.4 lbs. To fit Kemper™ & John Deere® heads • Strengthens & supports outer drum rotor ring Helps eliminate drum rotor cracking common on large drum heads 	
KK97974 (Left) KK97975 (Right) \$115.75 ea.	⑩	<ul style="list-style-type: none"> Stripper bar To fit JD® 678 SN. 113825 and above, all 778 heads & 770 before SN. 125396 heads • 12.4 lbs. 	LCA97974 LCA97975
KK94101 \$17.80 ea.	⑪	<ul style="list-style-type: none"> Divider point retainer • 2.5 lbs. To fit 678 SN. 113825 and above, 778, 475 & 460 heads 	LCA94101
KK90661 \$145.00 ea.	⑫	<ul style="list-style-type: none"> Skid plate • To fit JD® 778 heads • 4 required • 14.1 lbs. To fit Kemper™ & John Deere® 678 & 460 heads SN. 106051 and above 	LCA90661
KK93681 (Left) KK93682 (Right) \$27.80 ea.	⑬	<ul style="list-style-type: none"> Skid plate support • 4 each required To fit Kemper™ & JD® 460, 475, 678, 770, 460+, 778, 475+, 770+ rotary heads To fit NH600 heads • 2.9 lbs. 	LCA93681 LCA93682
KK69654 \$60.45 ea.	⑭	<ul style="list-style-type: none"> Wing drive coupler • 4 required To fit Kemper™ & John Deere® 678, 778 & 460 heads • 1.5 lbs. 	LCA69654 Heat Treated
KK97955 \$4.75 ea.	⑮	<ul style="list-style-type: none"> Rotating scraper • .15 lbs. • Bolt kit - KK92910BK, \$0.65 ea. To fit Kemper™ and JD® rotary heads 	LCA97955 / LCA92911 Abrasion Resistant
KK98764 (Left) (shown) KK98765 (Right) \$590.80 ea.	⑯	<ul style="list-style-type: none"> Outer 4 point large drum crop divider assembly To fit Kemper™ & John Deere® 678 & 460 rotary heads 1 of each required • 68 lbs. 	LCA98764 LCA98765
KK86023 \$1,390.00 ea.	⑰	<ul style="list-style-type: none"> Main drive clutch • Water cooled • 2 required To fit 678, 460, 460+ and 778 corn heads • 41 lbs. 	LCA86023
KK64557 \$39.00 ea.	⑱	<ul style="list-style-type: none"> Main drive clutch bearing To fit 678, 778, 770+, 475 & 475+ 	JD9241 LCA64557

Order online at WWW.KOOIMA.COM and receive **FREE FREIGHT** to your door!



KOOIMA® REPLACEMENT PARTS TO FIT KEMPER™ 770 ROTARY HEADS

Replacement parts produced by Kooima® Company to fit Kemper™ 770 Rotary Heads

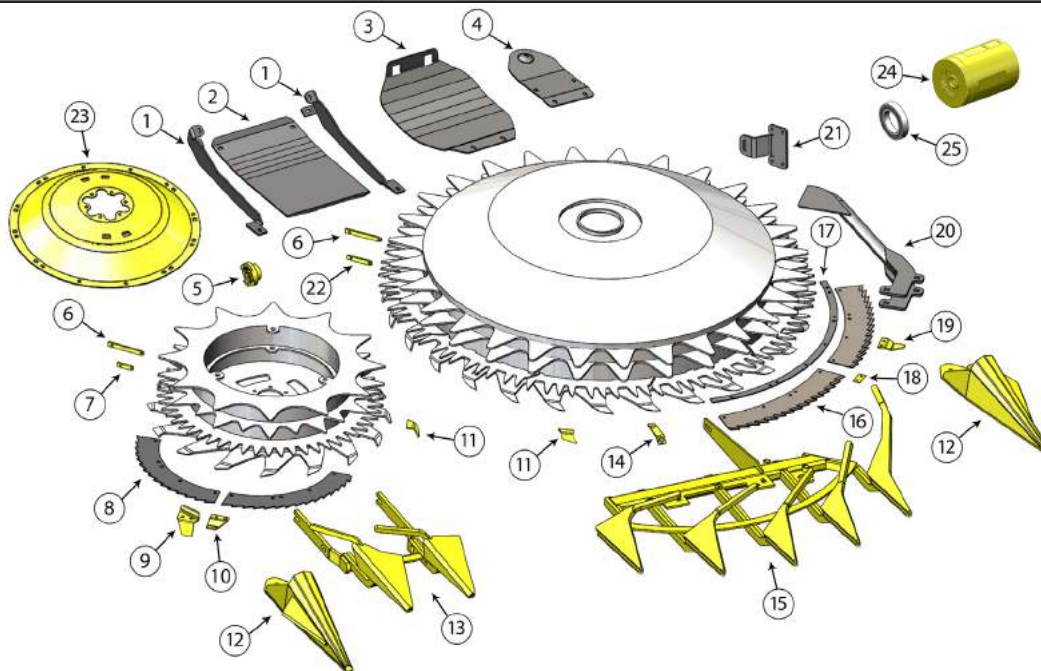

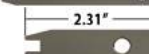

KOOIMA #	DESCRIPTION	REPLACES OEM #
KK93681 (Left) KK93682 (Right) \$27.80 ea.	1 • Skid plate support • 4 each required • To fit Kemper™ & JD® 460, 475, 678, 770, 460+, 778, 475+, 770+ rotary heads • To fit NH600 heads • 2.9 lbs.	LCA93681 LCA93682
KK90661 \$145.00 ea.	2 • Skid plate • To fit Kemper™ & JD® 460, 460+, 475, 475+, 678, 770, 770+, 778 heads SN. 106051 and above • To fit NH600 heads • 4 required • 14.1 lbs.	LCA90661
KK100120 \$79.00 ea.	3 • Skid Plate • 13.6 lbs. • To fit Kemper™ & JD® heads 690, 692, 698, 770 - before SN. 125396	LCA100120 Abrasion Resistant
KK94905 \$34.35 ea.	4 • Fender • 4.6 lbs. • For skid plate KK100120 • To fit Kemper™ & JD® heads 690, 692, 698 & 770 - before SN. 125396	LCA94905
KK69654 \$60.45 ea.	5 • Wing drive coupler • 4 required • To fit Kemper™ & JD® rotary heads • 1.5 lbs.	LCA69654 Heat Treated
KK92910 \$7.00 ea.	6  • Rotating scraper • .20 lbs. • To fit Kemper™ and JD® rotary heads • Bolt kit - KK92910BK, \$0.65 ea.	LCA92910 Abrasion Resistant
KK93241 \$5.75 ea.	7  • Rotating scraper • .12 lbs. • To fit Kemper™ and JD® rotary heads • Bolt kit - KK92910BK, \$0.65 ea.	LCA93241 Abrasion Resistant
KK67746 \$29.00 ea.	8 • Cutting blade • Each drum requires 4 blades • To fit John Deere® & Kemper™ small drum rotary heads • 2.1 lbs. • Also available in tungsten hard faced style - see pages 108-109	LCA67746/ LCA95957 Heat Treated High Carbon Material
KK94275(Left) KK94276 (Right) \$14.05 ea.	9 • Scraper • To fit Kemper™ 475 & JD® 770 outer drums SN. 117300 and below • 2 each required • Koyma Klad® coating • .55 lbs. ea.	LCA94275 LCA94276 Heat Treated
KK106457(Left) KK106458 (Right) \$14.05 ea.	9a • Scraper • To fit Kemper™ 475 & JD® 770 outer drums SN. 117301 and above • 2 each required • Koyma Klad® coating • .6 lbs. ea.	LCA106457 LCA106458 Heat Treated
KK69805 (Left) KK69806 (Right) \$10.75 ea.	10 • Blade scraper • Two required per rotor • .25 lbs. ea. • To fit John Deere® & Kemper™ small drum rotary heads • Left hand and right hand determined by direction of drum rotation	LCA69805/ LCA69806 Heat Treated Tungsten Carbide
KK90654 (Clockwise - RH) KK90655 (Counterclockwise - LH) \$4.25 ea.	11 • Intake disc weld-on sections • Note: do not weld on the leading edge of point • To fit all the Kemper™ heads • 12 required for small drum, 24 required for large drum • .15 lbs.	LCA90654 LCA90655 Abrasion Resistant
KK103004 (Left) KK103005 (Right) \$130.75 ea.	12 • Outside snoot • To fit Kemper™ & JD® heads 770 & 778, 475, 460+ & NH600 • 1 each required • 11.5 lbs. ea.	LCA103005/LCA103004 Abrasion Resistant
KK103062 (LH) KK103063 RH \$290.75 ea.	13 • Outside drum gathering points • To fit Kemper™ 475 and JD® 770 rotary heads • 28 lbs. • RH shown	LCA103062 LCA103063
KK95370 \$10.00 ea.	14 • Rotating scraper • .35 lbs. • To fit Kemper™ and JD® large drums	LCA95370
KK97977(Left) KK97978 (Right) \$660.00 ea.	15 • Inner large drum crop divider assembly • To fit 678, 460, 475, 770, 460+, 778, 475+ and 770+ corn heads • Also fits NH600 heads • Left hand shown	LCA97977 LCA97978
KK66037 \$27.00 ea.	16 • Cutting blade, large drum • To fit Kemper™ & JD® rotary heads • 2.8 lbs. • 8 required per drum • Also available in tungsten hard faced style - see pages 108-109	LCA66037 Heat Treated

KOOIMA® REPLACEMENT PARTS TO FIT KEMPER™ ROTARY HEADS

Replacement parts produced by Kooima® Company to fit Kemper™ 770 Rotary Heads

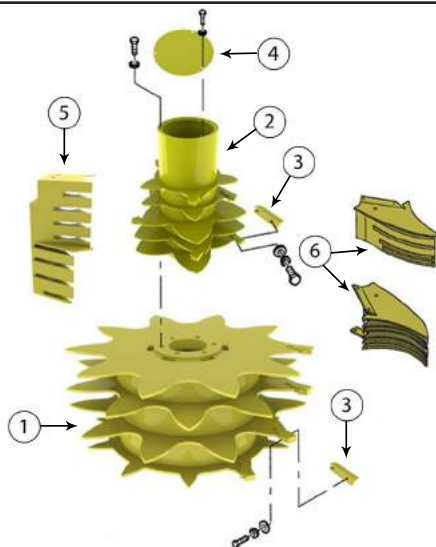
KOOIMA #	DESCRIPTION	REPLACES OEM #
KK89871SS \$26.80 ea.	⑰ • Drum rotor support strap • 4 required per drum • To fit Kemper™ & John Deere® heads • 1.4 lbs. • Strengthens & supports outer drum rotor ring • Helps eliminate drum rotor cracking common on large drum heads	
KK88009 \$4.20 ea.	⑱ • Support strap • 32 required • To fit Kemper™ & John Deere® rotary heads • .05 lbs.	LCA88009
KK67156 (Left) KK67157 (Right) \$10.75 ea.	⑲ • Blade scraper • To fit Kemper™ & John Deere® rotary heads • 4 each required • .25 lbs. ea.	LCA67156 LCA67157
KK97974 (Left) KK97975 (Right) \$115.75 ea.	⑳ • Stripper bar • To fit JD® 678 SN. 113825 and above, all 778's & 770 - before SN. 125396 heads • 12.4 lbs.	LCA97974 LCA97975
KK94101 \$17.80 ea.	㉑ • Divider point retainer • To fit JD® & Kemper™ 460, 475, 678 & 778 heads • 2.4 lbs.	LCA94101
KK97955 \$4.75 ea.	㉒  • Rotating scraper • .15 lbs. • To fit Kemper™ and JD® rotary heads • Bolt kit - KK92910BK, \$0.65 ea.	LCA97955 / LCA92911 Abrasion Resistant
KK109069 \$130.75 ea.	㉓ • Drum rotor • To fit JD® 770, 692, 698, 690, 696 small drums • To fit Kemper™ 475, 390+, 360+, 375+, 345+ small drums • 16.5 lbs.	LCA109069
KK86023 \$1,390.00 ea.	㉔ • Main drive clutch • Water cooled • 2 required • To fit 678, 460, 460+ and 778 corn heads • 41 lbs.	LCA86023
KK64557 \$39.00 ea.	㉕ • Main drive clutch bearing • To fit 678, 778, 770+, 475 & 475+	JD9241 LCA64557



KOOIMA #	DESCRIPTION	REPLACES OEM #
KK89830 (Left) shown KK89831 (Right) \$1,425.00 ea.	① • Drum • Serial # 113824 and below • To fit Kemper™ & John Deere® 678 & 460 heads and NH600 heads • 66 lbs. 	LCA89830 LCA89831
KK89830BK \$5.25 ea.	①a • Bolt kit for KK89830 & KK89831 • 1 kit required per drum • .75 lbs.	
KK89832 (Left) shown KK89833 (Right) \$750.80 ea.	② • Drum • Serial # 113824 and below • To fit Kemper™ & John Deere® 678 & 460 heads and NH600 heads • 44.4 lbs.	LCA89832 LCA89833
KK83225BK \$4.25 ea.	②a • Bolt kit for KK89832 & KK89833 • 1 kit required per drum • .3 lbs.	
KK83225 \$11.50 ea.	③ • Scraper • .25 lbs. • To fit Kemper™ & John Deere® 678 & 460 heads • Before serial # 113824 and NH600 heads	LCA83225 LCA88717
KK88717 \$11.25 ea.	④ • Cover plate • Serial # 113824 and below • 1.3 lbs. • To fit Kemper™ & John Deere® 678 & 460 heads and NH600 heads	
KK88717BK \$3.25 ea.	④a • Bolt kit for KK88717 • 1 kit required per cover • .1 lbs.	
KK86955 (Left) shown KK86956 (Right) \$425.80 ea.	⑤ • Stripper • Serial # 113824 and below • To fit Kemper™ & John Deere® 678 & 460 heads and NH600 heads • 40 lbs.	LCA86955 / LCA86956 Abrasion Resistant
KK86955BK \$3.75 ea.	⑤a • Bolt kit for KK86955 & KK86956 • 1 kit required per stripper • .25 lbs.	
KK89913 (LH) KK89914 (RH) \$380.00 ea.	⑥ • Drum scraper • To fit Kemper™ 460 & John Deere® 678 heads and NH600 heads • 41.1 lbs.	LCA89913 LCA89914

Order online at WWW.KOOIMA.COM and receive **FREE FREIGHT** to your door!

KOOIMA® REPLACEMENT PARTS TO FIT KEMPER™ AND JOHN DEERE® SMALL DRUM ROTARY HEADS

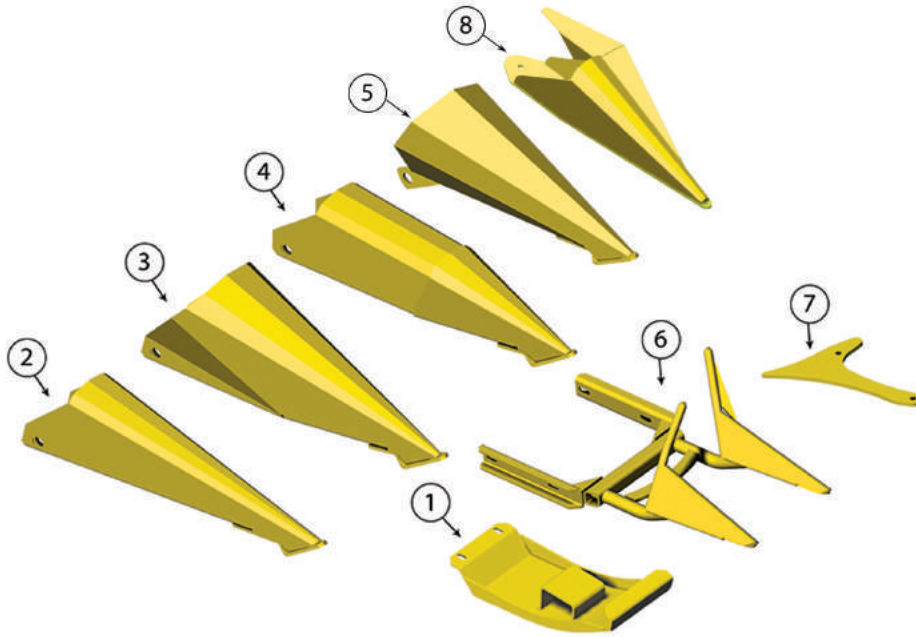

Replacement parts produced by Kooima® Company to fit Kemper™ & JD® Small Drum Rotary Heads

KOOIMA #	DESCRIPTION	REPLACES OEM #
KK72650 \$82.45 ea.	① • Skid plate • 1 required per row • Hardware Kit: KK72650BK, \$3.50 • To fit JD® 684-710 & Kemper™ 330, 340, 360, 375 & 6008 heads • Also fits JD® 710 10-row heads before 2002 • 13.4 lbs.	LCA72650 LCA84040 Abrasion Resistant
KK72650SP \$95.45 ea.	①a  • Low profile skid plate • 1 required per row • 12.4 lbs. • To fit same heads as KK72650 skid plate • Lower profile skid plate allows you to cut closer to the ground	LCA72650 LCA84040 Abrasion Resistant
KK75945 \$125.75 ea.	② • Crop divider snoot • To fit John Deere® 684, 686, 688, 710 heads and Kemper™ 330, 345, 360 and 6008 heads • 1 required per 4-row head • 3 required per 6-row head • 5 required per 8-row head • 5 required per 10-row head • 15.6 lbs. • Hardware kit - KK75945BK, \$8.85 ea.	LCA75945
KK76120 \$230.75 ea.	③ • Crop divider snoot • To fit John Deere® 684, 686, 688, 710 heads and Kemper™ 330, 345, 360 and 6008 heads • 1 each required • 14.6 lbs. • Hardware kit - KK75945BK, \$8.85 ea.	LCA76120 LCA76783
KK76791 \$140.75 ea.	④ • Crop divider snoot • To fit John Deere® 684, 686, 688, 710 heads and Kemper™ 330, 345, 360 and 6008 heads • 1 each required • 16.3 lbs. • Hardware kit - KK75945BK, \$8.85 ea.	LCA76791 LCA76790
KK67550 (Left) KK67551 (Right) \$125.00 ea.	⑤ • Wing crop divider snoot • To fit John Deere® 684, 686, 688, 710 heads and Kemper™ 330, 345, 360 and 6008 heads • 12.3 lbs. ea. • 1 each required • Left hand shown • Hardware kit - KK688BK, \$37.85 ea. when used on small drum rotary heads • Hardware kit - KK67550BK, \$17.05 ea. when used on large drum rotary heads	LCA67550 LCA67551
KK71385 (Left) KK71386 (Right) \$210.75 ea.	⑥ • Replacement crop divider assembly • To fit John Deere® 684, 686, 688, 710 heads and Kemper™ 330, 345, 360 and 6008 heads • 2 each required per 4-row head • 3 each required per 6-row head • 4 each required per 8-row head • 5 each required per 10-row head • 23.7 lbs. ea. • Hardware Kit: KK71385BK, \$8.25, .55 lbs. 1 bolt kit per crop divider	LCA71385 LCA71386
KK76776 \$17.10 ea.	⑦ • Crop guide • To fit John Deere® 686, 688, 710 heads and Kemper™ 345, 360, 375, 6008 heads • 2 required per 6-row • 3.9 lbs. ea. • 4 required per 8-row • 6 required per 10-row • Hardware kit - KK76776BK, \$2.30 ea.	LCA76776 Abrasion Resistant
KK102931 (Left) KK102932 (Right) \$115.75 ea.	⑧ • Outside snoot • 13.5 lbs. ea. • To fit Kemper™ & JD® 690, 692, 696 & 698 heads • Left hand shown • Hardware kit - KK102931BK, \$4.40 ea.	LCA102931 LCA102932 Abrasion Resistant

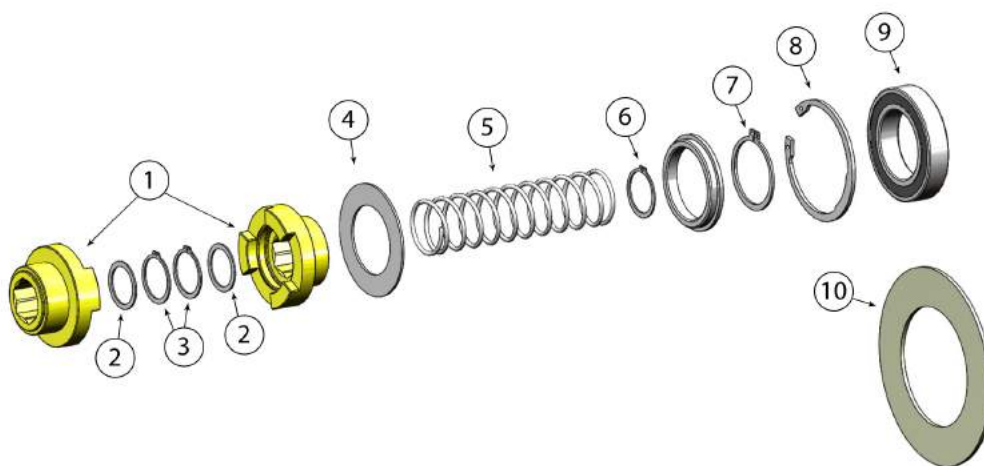

KOOIMA #	DESCRIPTION	REPLACES OEM #
KK69654 \$60.45 ea.	① • Wing drive coupler • To fit John Deere® 686, 688 & Kemper™ 345, 360, & 6008 series heads • 4 required • 1.5 lbs.	LCA69654
KK94215 \$65.45 ea.	①a • Wing drive coupler • To fit John Deere® 690, 692, 696 & 698 Kemper™ 345+, 360+, 375+ & 390+ corn heads • 4 required • 1.6 lbs.	Heat Treated LCA94215
KK24M7227 \$1.50 ea.	② • Washer • 4 required • .11 lbs.	24M7227
KK40M7098 \$1.40 ea.	③ • Snap ring • 4 required • .02 lbs.	40M7098
KK62684 \$8.75 ea.	④ • Clutch disc • 2 required • .15 lb.	LCA62684
KK64574 \$17.05 ea.	⑤ • Compression spring • 2 required • .5 lbs.	LCA64574
KK40M7109 \$4.25 ea.	⑥ • Snap ring • 4 required • .02 lbs.	40M7109 LCA11648
KK05539 \$6.00 ea.	⑦ • Snap ring • 2 required • .02 lbs.	LCA05539/LCA12228 40M7066/40M1841
KK05375 \$10.00 ea.	⑧ • Snap ring • 2 required • .15 lbs.	LCA05375 40M7060/40M1873
KK64557 \$39.00 ea.	⑨ • Bearing for wing drive coupler • 4 required • .9 lbs.	LCA64557 JD9241
KK59046 \$27.50 ea.	⑩ • Clutch friction disc • 4 required per clutch • To fit 684, 686 & 688 main clutch drive • .1 lbs.	DC38275 LCA59046

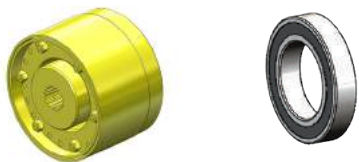

KK70300 \$550.00 ea.	• Complete slip clutch • 24.6 lbs. • 2 required per head • To fit 684-688 SN# 103954 & above - all 696 & 345+ - • 330, 345, 360 SN# 105200 & above, 710 before SN# 103953	LCA70300
KK92955 \$950.00 ea.	• Main drive clutch • 37 lbs. • 2 required per head • To fit 686, 688, 710 SN# 103954 & above - 345, 360, 375 SN# 105200 & above • All 345+, 360+, 375+, 690, 696 and 698 heads	LCA92955
KK76350 \$550.00 ea.	• Slip clutch • 23 lbs. • 2 required • To fit 686, 688 SN # 051300 - 103953 and 684 SN# before 103853	LCA76350
KK64557 \$39.00 ea.	• Main drive clutch bearing • To fit all Kemper™ & JD® small drum corn heads • To fit 678, 778, 770+, 475 & 475+	JD9241 LCA64557



KOOIMA® REPLACEMENT PARTS TO FIT KEMPER™ AND JOHN DEERE® SMALL DRUM ROTARY HEADS

Replacement parts produced by Kooima® Company to fit Kemper™ & JD® Small Drum Rotary Heads

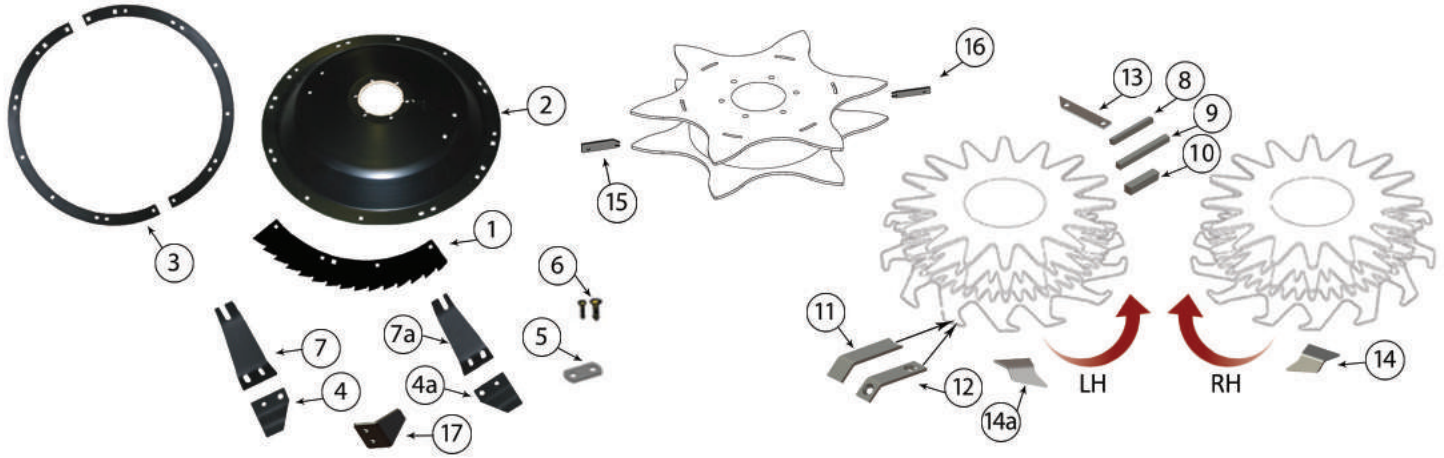

KOOIMA #	DESCRIPTION	REPLACES OEM #
KK67746	• Cutting blade • To fit John Deere® and Kemper™ small drum rotary heads • Each drum requires 4 blades • 2.1 lbs. • Also available in tungsten hard face style - see pages 108 & 109	LCA67746/LCA95957 Heat Treated High Carbon Material
\$29.00 ea.	①	
KK76761	• Drum rotor • To fit all John Deere® 684, 686, 688 and Kemper™ 330, 345, 360 corn heads (round center hole) • 13.9 lbs. • Hardware Kit: KK76761BK, \$6.00 ea., .35 lbs.	LCA76761
\$159.00 ea.	②	
KK76761SS	• Drum rotor support strap • To fit John Deere® and Kemper™ small drum rotary heads • Strengthens and supports outer drum rotor edge helping eliminate drum rotor cracking • 2 required per drum • Install on top of rotor • 1.8 lbs.	
\$29.30 ea.	③	
KK69805 (Left)	• Blade scraper • To fit John Deere® and Kemper™ small drum rotary heads	LCA69805/ LCA69806
KK69806(Right)	• 2 required per rotor • .25 lbs. ea.	Heat Treated Tungsten Carbide
\$10.75 ea.	④ ④a	
KK76374	• Support strap • To fit all John Deere® and Kemper™ small drum rotary heads • 1 required per blade • .05 lbs.	LCA76374
\$3.10 ea.	⑤	
KK6006BK	• 6 Row hardware kit • To fit John Deere® and Kemper™ small drum rotary heads up to a 6 row • Includes all the hardware required to replace a full set of blades and scrapers • Does not work when using KK76761SS support straps • 5 lbs.	
\$68.45 ea.	⑥	
KK6000BK	• Hardware kit • To fit John Deere® and Kemper™ small drum rotary heads • 7.8 lbs. • Includes all the hardware required to replace a full set of blades and scrapers	
\$90.45 ea.	⑥a	
KK6000BKSS	• Support strap hardware kit • Longer bolts when using KK76761SS support straps • 1 kit required per head • 7.7 lbs.	
\$94.45 ea.	⑥b	
KK72851(Left)	• Scraper holder • To fit John Deere® and Kemper™ small drum rotary heads	LCA72851/LCA72852
KK72852(Right)	• Two required per rotor • .65 lbs. ea.	Heat Treated Tungsten Carbide
\$6.40 ea.	⑦ ⑦a	
KK69561	• Top rotating scraper • 2 required per drum • .3 lbs. ea.	LCA69561
\$6.00 ea.	⑧	
KK70937	• Middle scraper • 2 required per drum • .35 lbs. ea.	LCA70937
\$5.15 ea.	⑨	
KK69560	• Bottom scraper • 2 required per drum • .15 lbs. ea.	LCA69560
\$5.15 ea.	⑩	
KK71242	• Weld on scraper small drum • 2 required per drum • .2 lbs.	LCA71242 Abrasion Resistant
\$5.25 ea.	⑪	
KK87284	• Bolt-on scraper small drum • .2 lbs. • To fit JD® 684-710 & Kemper™ 330-375 • 2 required per drum • KK87284BK- bolt kit, 1 required/scraper, \$3.25 ea., .01 lbs.	LCA87284 Abrasion Resistant
\$9.25 ea.	⑫	
KK83254	• Bolt-on scraper small drum • To fit JD® 684-710 SN. 105200 & above & Kemper™ 330-375 SN. 103954 & above • 4 required per drum • .15 lbs.	LCA83254 Abrasion Resistant
\$6.15 ea.	⑬	
KK90654 (Clockwise - RH)	• Intake disc weld-on sections • Note: do not weld on the leading edge of point	LCA90654
KK90655 (Counterclockwise - LH)	• To fit all the Kemper™ heads 330, 345, 375 ,6008, 4500, 676, 445, 460, 475	LCA90655
\$4.25 ea.	⑭ ⑭a	Abrasion Resistant
KK109129	• Rotating scraper • .20 lbs. • To fit 390+, 692, 360+, 375+, 698, 690, 345+ & 696 heads • Bolt kit: KK92910BK - \$0.65 ea.	LCA109129 Abrasion Resistant
\$4.75 ea.	⑮	
KK97955	• Rotating scraper • .15 lbs. • To fit 390+, 692, 360+, 375+, 698, 690, 345+ & 696 heads • Bolt kit: KK92910BK - \$0.65 ea.	LCA97955/LCA92911 Abrasion Resistant
\$4.75 ea.	⑯	

KOOIMA #

KK106339

\$9.25 ea.

17

DESCRIPTION

- Scraper support • .4 lbs. • SN 117303 to 124314
- To fit 390+, 692, 360+, 375+, 698 & 690 heads
- Aggressive deck plate kit • Improved feeding in down crops
- 345-686: 1 kit required, 360-608: 2 kits required, 375-690: 3 kits required
- 1 kit does 2 drums • 60 lbs. • JD® heads pre 2004 need 4 holes drilled

REPLACES OEM #

LCA106339

Heat Treated

LCA109357

KK109357

\$530.00 ea.

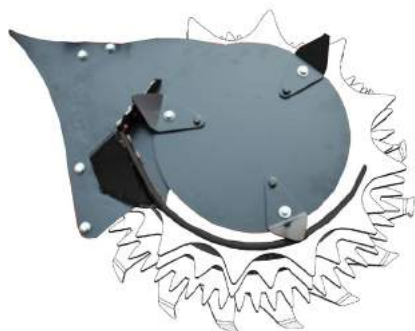

Replacement parts produced by Kooima® Company to fit Kemper™ & JD® Small Drum Rotary Heads

High Quality Silage Covers

String Tarps White/Black - 6.0 mil (R6WBK)

Part #	Price	W X L	Weight
K59X200M6	\$892.50	59.5 X 200	370 lbs.
K59X500M6	\$2,231.25	59.5 X 500	780 lbs.
K85X250M6	\$1,607.85	85.75 X 250	585 lbs.
K85X1000M6	\$6,431.25	85.75 X 1000	2,275 lbs.
K105X40M6	\$316.50	105.5 X 40	172 lbs.
K105X60M6	\$474.75	105.5 X 60	237 lbs.
K151X45M6	\$511.35	151.5 X 45	220 lbs.
K151X50M6	\$568.15	151.5 X 50	250 lbs.
K151X60M6	\$681.75	151.5 X 60	272 lbs.
K151X70M6	\$795.40	151.5 X 70	315 lbs.
K151X75M6	\$852.20	151.5 X 75	335 lbs.
K151X80M6	\$909.00	151.5 X 80	370 lbs.
K151X100M6	\$1,136.25	151.5 X 100	430 lbs.
K184X70M6	\$968.65	184.5 X 70	405 lbs.
K184X110M6	\$1,522.15	184.5 X 110	550 lbs.
K204X50M6	\$765.95	204.25 X 50	315 lbs.
K204X60M6	\$919.15	204.25 X 60	380 lbs.
K204X70M6	\$1,072.35	204.25 X 70	420 lbs.
K204X80M6	\$1,225.50	204.25 X 80	465 lbs.
K204X100M6	\$1,531.90	204.25 X 100	550 lbs.
K243X60M6	\$1,096.90	243.75 X 60	455 lbs.
K250X70M6	\$1,313.85	250.25 X 70	545 lbs.
K250X80M6	\$1,501.50	250.25 X 80	590 lbs.
K250X85M6	\$1,595.35	250.25 X 85	615 lbs.
K303X100M6	\$2,272.50	303 X 100	870 lbs.



Detail of reinforced string tarps

String Tarps White/Black - 8.0 mil (R8WBK)

Part #	Price	W X L	Weight
K8M84X200	\$1,300.00	84 X 200	600 lbs.
K8M84X250	\$1,600.00	84 X 250	750 lbs.

If you do not see the size you need, give us a call, other sizes are available upon request.

Prices are subject to change.

*** Free shipping on Silage Covers if combined with \$750 in Kooima® parts on phone and internet orders**



FEATURED PRODUCTS

7000 & 8000 Series Bumper

Features:

- Adjustable bumper pads to protect your cutter from damage
- Lowered hitch allows for better alignment
- Weight rack designed to use standard suitcase weights
- Included chain or tow rope connection
- Proudly made in the USA

675 lbs.

Order # K125061

\$2,950⁰⁰ ea.

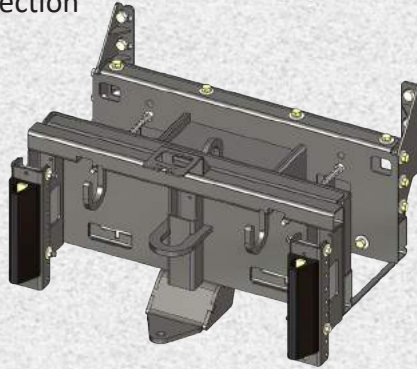

TURNER[®]
COMPOSTER

Kooima[®] Trner[®] Composters

(Patents Pending)

Don't turn piles at the back of the pack any longer. Kooima[®] Composters innovative new rotor design allows for faster travel speeds with superior product movement and aeration. Call today for more information!

Additional information on back inside cover!



FEATURED PRODUCTS

Koyma Klad® parts utilize the latest technology of high grade carbide weld coating. With the ability to achieve up to 75% carbide content in a highly bonded weld matrix, Koyma Klad® parts are proven to wear longer and last longer. Find all of our Koyma Klad® coated products listed in blue.

Koyma Klad® Coated Bale Processor Flails

These high performance flails will fit Vermeer®, Highline®, Haybuster® and Fair MFG bale processors. See page 2 for more information.



Koyma Klad® Universal Knife

These universal "C" shaped knives will fit Claas® 494, 496 & 497 series. See page 133 for more information.



Koyma Klad® Hi-Performance Wear Ledge

These wear ledges include a hard faced wear area, tungsten carbide and our exclusive Koyma Klad® extended wear coating. We have these to fit Claas® 491-498 series. See page 141 for more information.



Koyma Klad® Hi-Performance Double Sine Wave Shearbar

Maximize your shearbar's cutting surface! Koyma Klad® coating maintains a long lasting sharp edge for more tons per hour. Patent # 8,109,176

We have these style shearbars to fit John Deere® and Claas® machines.

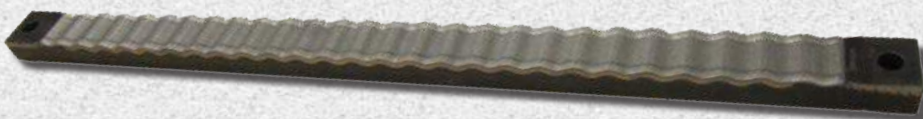

Order online at WWW.KOOIMA.COM and receive FREE FREIGHT to your door!

KOOIMA
COMPANY



123

NEW PARTS to fit KRONE®

KOOIMA #
KR200258942
 \$2,690.00 ea.



DESCRIPTION

- Upper front feed roll
- Fits Krone® 500,600,600-2, 600-3, 650, 700, 700-1, 700-2, 700-3, 750c, 770-1, 770-2, 770-3, 800, 850, 850-1, 850-2, 1000, 1100, 1100-1, 1100-2 models

REPLACES OEM #
 200258942

KR200259100
 \$660.80 ea.



- Upper intermediate roll
- Fits Krone® 500, 600, 600-2, 600-3, 650, 700, 700-1, 700-2, 700-3, 750c, 770-1, 770-2, 770-3, 800, 850, 850-1, 850-2, 1000, 1100, 1100-1, 1100-2 models

200259100

KR200223040
 \$590.80 ea.



- Upper rear feed roll
- Fits Krone® 500,600,600-2, 600-3, 650, 700, 700-1, 700-2, 700-3, 750c, 770-1, 770-2, 770-3, 800, 850, 850-1, 850-2, 1000, 1100, 1100-1, 1100-2 models

200223040

KR200259671
 \$2,640.00 ea.



- Lower front feed roll
- Fits Krone® 500,600,600-2, 600-3, 650, 700, 700-1, 700-2, 700-3, 750c, 770-1, 770-2, 770-3, 800, 850, 850-1, 850-2, 1000, 1100, 1100-1, 1100-2 models

200259671

KR200204693
 \$690.80 ea.



- Lower intermediate roll
- Fits Krone® 500,600,600-2, 600-3, 650, 700, 700-1, 700-2, 700-3, 750c, 770-1, 770-2, 770-3, 800, 850, 850-1, 850-2, 1000, 1100, 1100-1, 1100-2 models

200204693

KR200294470
 \$1,150.00 ea.



- Lower rear feed roll
- Fits Krone® 500,600,600-2, 600-3, 650, 700, 700-1, 700-2, 700-3, 750c, 770-1, 770-2, 770-3, 800, 850, 850-1, 850-2, 1000, 1100, 1100-1, 1100-2 models

200294470

KR200299891
 \$148.00 ea.



- Sharpening stone - 9 7/8" long
- Fits Krone® 480, 480st3, 530, 630, 680, 680st0, 780, 780st0, 880 and 1180 models

200299891

KR202293311 - RH
KR202293301 - LH
 \$59.60 ea.



- Corn knife
- Fits Krone® 600-2, 700-2, 770-2, 750, 850-2, and 1100-2 models

202293311

202293301

KR202293391 - RH
KR202293301 - LH
 \$62.20 ea.



- Universal knife
- Fits Krone® 600-2, 700-2, 770-2, 750, 850-2, and 1100-2 models

202293391

202293381

NEW PARTS to fit NEW HOLLAND®

KOOIMA #
K83592
 \$29.95 ea.



DESCRIPTION

- Poly pickup band
- Fits New Holland® models 280FP, 290FP, 380FPA, 346W, 356W and 366W

REPLACES OEM #
 87584380

K83489
 \$29.95 ea.



• Poly pickup band - mounting hardware included 86625272
 • Fits New Holland® models 27P, 29P, 707W, 717W, 770W, 790W, 880W, 890W, 900W, 919W3, 919W4 and 990W

K84568340
 \$725.00 ea.



• Transition channel concave
 • Fits New Holland® FR450 - 920 series

84568340
Abrasive Resistant

K84553240
 \$1,050.00 ea.



• Transition chute wear plate
 • Fits New Holland® FR series after SN 888

84553240
Abrasive Resistant

K84553240LN
 \$890.00 ea.

Heavy duty version shown

• Transition chute wear plate - aftermarket
 • Fits New Holland® FR series after SN 888

84553240
Abrasive Resistant

K47550392
 \$1,995.00 ea.

• Heavy duty transition chute wear plate
 • Fits New Holland® FR series after SN 888

47550392
Tungsten Carbide

K84547800
 \$1,550.00 ea.



• Drum bottom
 • Fits all New Holland® FR series

84547800
Abrasive Resistant

K87567972
 \$495.00 ea.



• Cutter head stone cover
 • Fits all New Holland® FR series

87567972

K47541082
 \$280.00 ea.



• Transition chute end liner
 • Fits New Holland® FR series after SN 878

47541082

K47532471 - RH
K47532473 - LH
 \$98.00 ea.



• Blower wear plates
 • Fits New Holland® FR series after SN 876

47532471
 47532473

K87736807 - RH
K87736805 - LH
 \$495.00 ea.



• Cast shear bar wear ledge
 • Fits all New Holland® FR series

87736807
 87736805

K86635950
 \$24.50 ea.













• Knife baffle
 • Fits New Holland® FP240 harvesters

86635950

Order online at WWW.KOOIMA.COM and receive **FREE FREIGHT** to your door!



NEW PARTS to fit CLAAS®

KOOIMA #		DESCRIPTION	REPLACES OEM #
K0762215 \$530.00 ea.		<ul style="list-style-type: none"> • Tooth rimmed spout ring gear • To fit Claas® 491 and 487 series (820/840/860/880) 	0762215
K0762224 \$245.00 ea.		<ul style="list-style-type: none"> • Spout ring • To fit Claas® 492 and 493 series (830/850/870/890/900) 	0762224
K0689801 \$540.00 ea.		<ul style="list-style-type: none"> • Toothed rimmed spout ring gear • To fit Claas® 492 and 493 series (830/850/870/890/900) 	0689801
K14101721 - LH K14101731 - RH \$174.75 / set		<ul style="list-style-type: none"> • Grass knife set • To fit Claas® 494, 496, 497, 498 & 499 • Includes 2 knives and 4 bolts per set 	14101721 / 04844503 14101731 / 04844513
K14101701 - LH K14101711 - RH \$174.00 / set		<ul style="list-style-type: none"> • Corn knife kit • To fit Claas® 494, 496, 497 & 498 series • Includes 2 knives and 4 bolts per set Heat treated / Tungsten carbide 	14101701 14101711
K26097430 \$290.00 ea.		<ul style="list-style-type: none"> • Cast shearbar wear ledge • To fit Claas® 492 series after SN 49207133 and 496 series 	26097430 / 4958380
K9064370 \$305.00 ea.		<ul style="list-style-type: none"> • Cast shearbar wear ledge • To fit Claas® 493 series 	9064370
K13244381 \$305.00 ea.		<ul style="list-style-type: none"> • Cast shearbar wear ledge • To fit Claas® 494 series SN 49403008 to 4940352 & from 49403883 	1324438
K13903510 \$290.00 ea.		<ul style="list-style-type: none"> • Cast shearbar wear ledge • To fit all Claas® 497 series 	1390351
K9061762 \$270.00 ea.		<ul style="list-style-type: none"> • Smooth roll cleaner • To fit Claas® 493 series and 494 series up to SN 49401494 	9061760
K4952911 \$330.00 ea.		<ul style="list-style-type: none"> • Smooth roll cleaner - Hard faced for longer life! • To fit Claas® 493 series and 494 series up to SN 49401494 Tungsten carbide 	4952910
K13188332 \$355.00 ea.		<ul style="list-style-type: none"> • Smooth roll cleaner - Hard faced for longer life! • To fit Claas® 494 series from SN 494001495 and 497 series Tungsten carbide 	1318833
K1302591 - RH K1302581 - LH (shown) \$225.00 ea.		<ul style="list-style-type: none"> • Accelerator housing wear plate • To fit Claas® 492, 493, 494, 496 & 497 series • Counter sunk holes • Hard faced for longer life! Tungsten carbide • Bolt Kit: K0762182BK, \$13.00 ea. - 1 kit required per wear plate 	1302591 1302581

NEW PARTS to fit CLAAS®

KOOIMA #

K9062020

\$1,575.00 ea.

DESCRIPTION

- Upper rear feed roll
- To fit Claas® 494 series harvesters

REPLACES OEM #

9062020

Stainless steel

K9863261

\$1,575.00 ea.

- Upper rear feed roll
- To fit Claas® 496 series harvesters

9863261

Stainless steel

K13248910

\$1,575.00 ea.

- Upper rear feed roll
- To fit Claas® 497 series harvesters

13248910

Stainless steel



K4920DRUM

\$8,350.00 ea.

- Cutter drum assembly
- To fit all Claas® 491, 492 & 493 series w/ 20 knife cylinder
- Complete with K9873363 and K9846695 drive shafts

K9846695

\$1,225.00 ea.

- RH drive shaft
- To fit Claas® 491, 492 & 493 series

9846695

K9873363

\$1,375.00 ea.

- LH drive shaft
- To fit Claas® 491, 492 & 493 series

9873363



K1231120

\$229.00 ea.

- Filler housing wear plate

1231120

- To fit Claas® 494 series from SN 49402913 & after & all 496 & 497 **Abrasive Resistant**

K24012045

\$275.00 ea.

- Filler housing wear plate

24012045

- To fit Claas® 498 series

Abrasive Resistant



K1231056

\$368.05 ea.

- Feed guide

1231056

- To fit Claas® 494 SN 49402914 & after & all 496 & 497



K20X9

\$155.00 ea.

- Replacement drive shaft - 9" long

Heat Treated

- 1 3/4" 20 spline



K3837501

\$53.50 ea.

- Large drum counter clockwise rotation knife - new style

3837501

- To fit Claas® Orbis® 600, 750 & 900 heads

Tungsten hard-faced

- 6 required per drum

Head Treated



K3837371

\$53.50 ea.

- Large drum clockwise rotation knife - new style

3837371

- To fit Claas® Orbis® 600, 750 & 900 heads

Tungsten hard-faced

- 6 required per drum

Head Treated



K23008341

\$47.25 ea.

- Small drum counter clockwise rotation knife - new style

23008341

- To fit Claas® Orbis® 750 & 900 heads

Tungsten hard-faced

- 3 required per drum

Head Treated



K23008361

\$47.25 ea.

- Small drum clockwise rotation knife - new style

23008361

- To fit Claas® Orbis® 750 & 900 heads

Tungsten hard-faced

- 3 required per drum

Head Treated



NEW PARTS to fit JOHN DEERE®

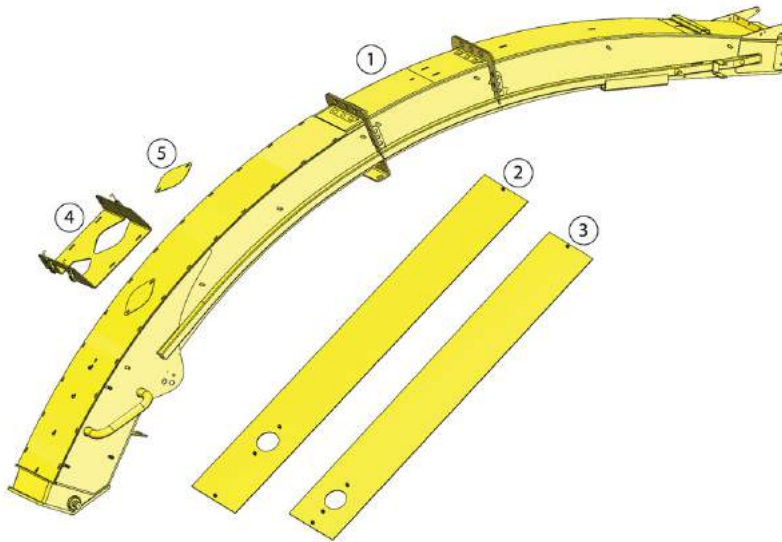

KOOIMA #	DESCRIPTION	REPLACES OEM #
K100830 \$3,100.00 ea.	① • High arch spout - Now equipped to accept moisture sensors! • To fit John Deere® series equipped with 250mm wide high arch spout • Will need to order K102820 moisture sensor bracket • 475 lbs.	AZ104282 Abrasion resistant
K101740 \$175.75 ea.	② • Lower back spout liner - 2000mm long • 32.3 lbs. • Before SN 51024 • To fit all 250mm spouts equipped with JD® moisture sensor & Kooima spouts	AZ101740 Abrasion resistant
K103382 \$120.00 ea.	③ • Lower back spout liner - 1800mm long • 28 lbs. • After SN 51024 • To fit all 250mm spouts equipped with JD® moisture sensor	AZ103382 Abrasion resistant
K102820 \$360.80 ea.	④ • Moisture sensor bracket • To fit Kooima 250mm spouts only	AZ102820
K102637 \$43.85 ea.	⑤ • Moisture sensor • To fit JD® 250mm spouts when not using moisture sensor	AZ102637 Abrasion resistant

KOOIMA #	DESCRIPTION	REPLACES OEM #
K83564 \$335.00 ea.	 <ul style="list-style-type: none"> • Smooth roll scraper • 7.5 lbs. • To fit John Deere® 8100-8500 series 	HXE83564 / HXE113274 Heat treated

K83563 \$335.00 ea.	 <ul style="list-style-type: none"> • Smooth roll scraper • 9.5 lbs. • To fit John Deere® 8600-8800 & 9600-9900 series 	HXE83563 Heat treated
-------------------------------	---	---------------------------------

K16953 \$54.65 ea.	<ul style="list-style-type: none"> • Cutterhead support plate • To fit JD® 7180, 7200, 7300, 7400, 7500, 7250, 7280, 7350, 7450, 7480, 7550, 7580, 7700, 7800 and 7750 up to SN 510523 	HXE16953
------------------------------	--	----------

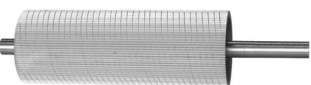
K8600HPF (Fast 124 tooth) K8600HPS (Slow 138 tooth) \$2,260.00 ea.	 <ul style="list-style-type: none"> • Kernel processor roll • To fit Scherer™ processors made to fit JD® 8600-8800 series wide body SPFH • High capacity Fiber Tech, chevron design 	Heat treated / Chromed
--	--	-------------------------------

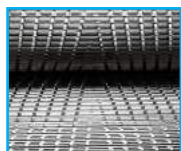

Detail of Chevron style processor rolls

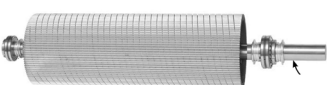
K8600HPBF (Fast 124 tooth) K8600HPBS (Slow 138 tooth) \$3,020.00 ea.	 <ul style="list-style-type: none"> • Kernel processor roll • To fit Scherer™ processors made to fit JD® 8600-8800 series wide body SPFH • Bearings included and installed • High capacity Fiber Tech, chevron design 	Heat treated / Chromed
--	---	-------------------------------

NEW PARTS to fit JOHN DEERE®

KOOIMA #	DESCRIPTION
K8000KIT \$435.00 ea.	① • Earlage side wall plates and feed roll separation kit • To fit JD® 8100-8500 series and 8600 series up to SN 618999
K77626 \$29.80 ea.	② • LH earlage kit side plate • 1 required • Replaces OEM HXE77626 • To fit JD® 8100-8500 series and 8600 series up to SN 618999
K63586 \$38.85 ea.	③ • RH earlage kit side plate • 1 required • Replaces OEM HXE63586 • To fit JD® 8100-8500 series and 8600 series up to SN 618999
K63579 \$46.85 ea.	④ • Earlage shim • 2 required • .75" thick • Replaces OEM HXE63579 • To fit JD® 8100-8500 series and 8600 series up to SN 618999
K101368 \$9.50 ea.	• Earlage shim • .18" thick • Quantity used as required • Replaces OEM HXE101368 • To fit JD® 8100-8500 series and 8600 series up to SN 618999

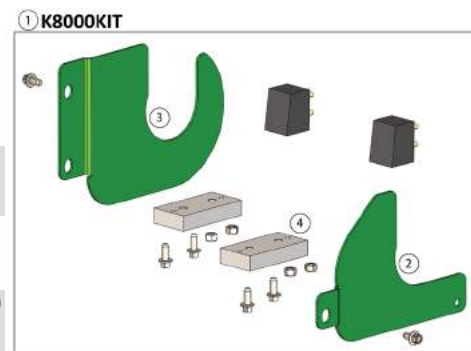

**When replacing the cutter drum on your 7000 series harvester, order the following parts:
Used on John Deere® 7750, 7780, 7950 and 7980 series, SN 510524 and above**

KOOIMA #	DESCRIPTION	REPLACES OEM #
K85741 \$173.00 ea.	 • Bushing • 1 required	HXE85741
K103847 \$22.50 ea.	 • Seal • 3 required	AZ103847
K103850 \$246.00 ea.	 • Bearing • 1 required	AZ103850
K40M7232 \$16.50 ea.	 • Snap ring • 2 required	40M7232
K105053 \$788.00 ea.	 • Bearing housing without bearing • 1 required	Z105053
K87418 \$192.00 ea.	 • Bushing • 1 required	HXE87418
K105057 \$57.05 ea.	 • Plate • 1 required	Z105057
K19M8542 \$8.25 ea.	 • Cap screw, M16x190 • 5 required	19M8542
K87420 \$88.00 ea.	 • Bushing • 1 required	HXE87420
K103851 \$121.00 ea.	 • Bearing • 1 required	AZ103851
K105052 \$600.00 ea.	 • Bearing housing without bearing • 1 required	Z105052
K31754 \$5.00 ea.	 • Washer • 2 required	HXE31754
K103848 \$26.50 ea.	 • Seal • 2 required	AZ103848
K40M7217 \$9.25 ea.	 • Snap ring • 1 required	40M7217
K87419 \$98.00 ea.	 • Bushing • 1 required	HXE87419
K19M7732 \$6.90 ea.	 • Cap screw, M16x130 • 5 required	19M7732

Order online at WWW.KOOIMA.COM and receive **FREE FREIGHT** to your door!



NEW PARTS to fit Meyer™ Mixers

KOOIMA #
K1110012

\$26.00 ea.



DESCRIPTION

- New style knife section • Patent # 8,186,611
- To fit Meyer™ 585, 700, 815, 1015 and 1215 mixers
- 2 required per backing plate
- **K1110012BK** - hardware kit, \$3.40 per blade

K1110040
\$31.50 ea.

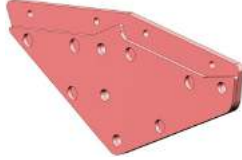

- Standard backing plate
- To fit Meyer™ 585, 700, 815, 1015 and 1215 mixers
- Patent # 8,186,611
- **K1110040BK** - hardware kit, \$2.25 ea.

K1110041
\$40.50 ea.



- Heavy duty backing plate
- To fit Meyer™ 585, 700, 815, 1015 and 1215 mixers
- Patent # 8,186,611
- **K1110041BK** - hardware kit, \$2.25 ea.

K385024BIT
\$31.75 ea.



- Early knife style section • Patent # 8,186,611
- To fit early model Meyer™ mixers • 2 required
- **K385024BITBK** - hardware kit, \$2.75 ea.

K1110040KIT
\$83.50 ea.

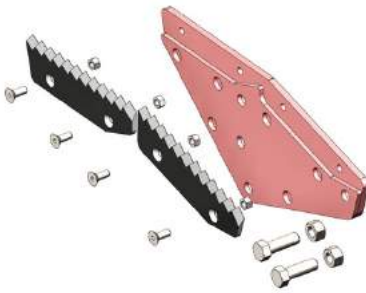

- Complete knife kit with standard backing plate
- To fit Meyer™ 585, 700, 815, 1015 and 1215 mixers
- Patent # 8,186,611
- Kit includes:
- (2) K1110012
- (2) K1110012BK's
- (1) K1110040
- (1) K1110040BK

K1110041KIT
\$92.50 ea.

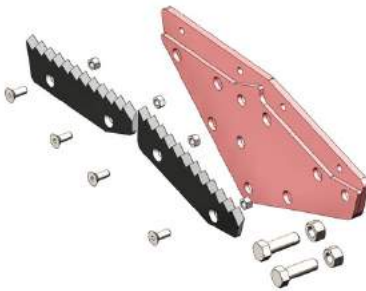

- Complete knife kit with heavy duty backing plate
- To fit Meyer™ 585, 700, 815, 1015 and 1215 mixers
- Patent # 8,186,611
- Kit includes:
- (2) K1110012
- (2) K1110012BK's
- (1) K1110041
- (1) K1110041BK

NEW PARTS to fit Kuhn Knight®

K117140
\$115.00 ea.



- Vertical discharge knife • Replaces OEM # 76117140
- To fit Kuhn Knight® vertical mixers • **Heat treated / Tungsten carbide**
- **K144734BK** - Hardware kit, \$3.50 ea. per blade

NEW PARTS to fit Patz® Mixers

KOOIMA #
K21831



\$29.80 ea.

DESCRIPTION

- Plow wing
- To fit Patz® 800 series mixers
- 1 required • 3.5 lbs.
- Replaces OEM # PA-21831 / PA24653

AR400 material

K24648



\$38.60 ea.

- Plow wing
- To fit Patz® 1200-2400 series mixers
- 1 required • 5.5 lbs.
- Replaces OEM # PA-24648

AR400 material

Available Soon

New serrated solid carbide insert knives!

- Available for Supreme™, Jay-lor®, Penta™, Art's-Way™, Diamond™, Haybuster®, Maximixer™ and Valmetal® mixers!
 - Same long lasting design now with a more aggressive cutting edge
 - Patent pending
- Call for pricing

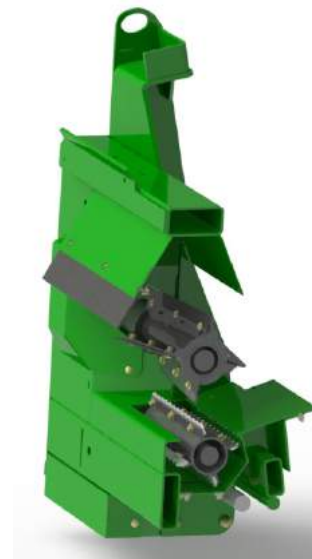
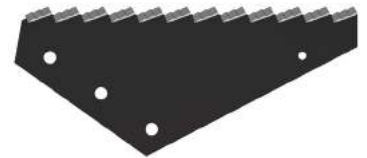
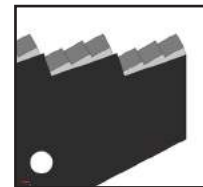

K9000 Earlage Adapter

Patent # 8,376,126

Patent Pending

Will fit all John Deere® 8000 and 9000 series harvesters.

Call for Pricing

Order online at WWW.KOOIMA.COM and receive FREE FREIGHT to your door!

KOOIMA
COMPANY



Kooima® Replacement Parts To Fit CLAAS®

KOOIMA® REPLACEMENT PARTS TO FIT CLAAS® FORAGE HARVESTERS

Claas® is a registered trademark of Claas KGaA, MBH, which does not manufacture, distribute or endorse these parts.

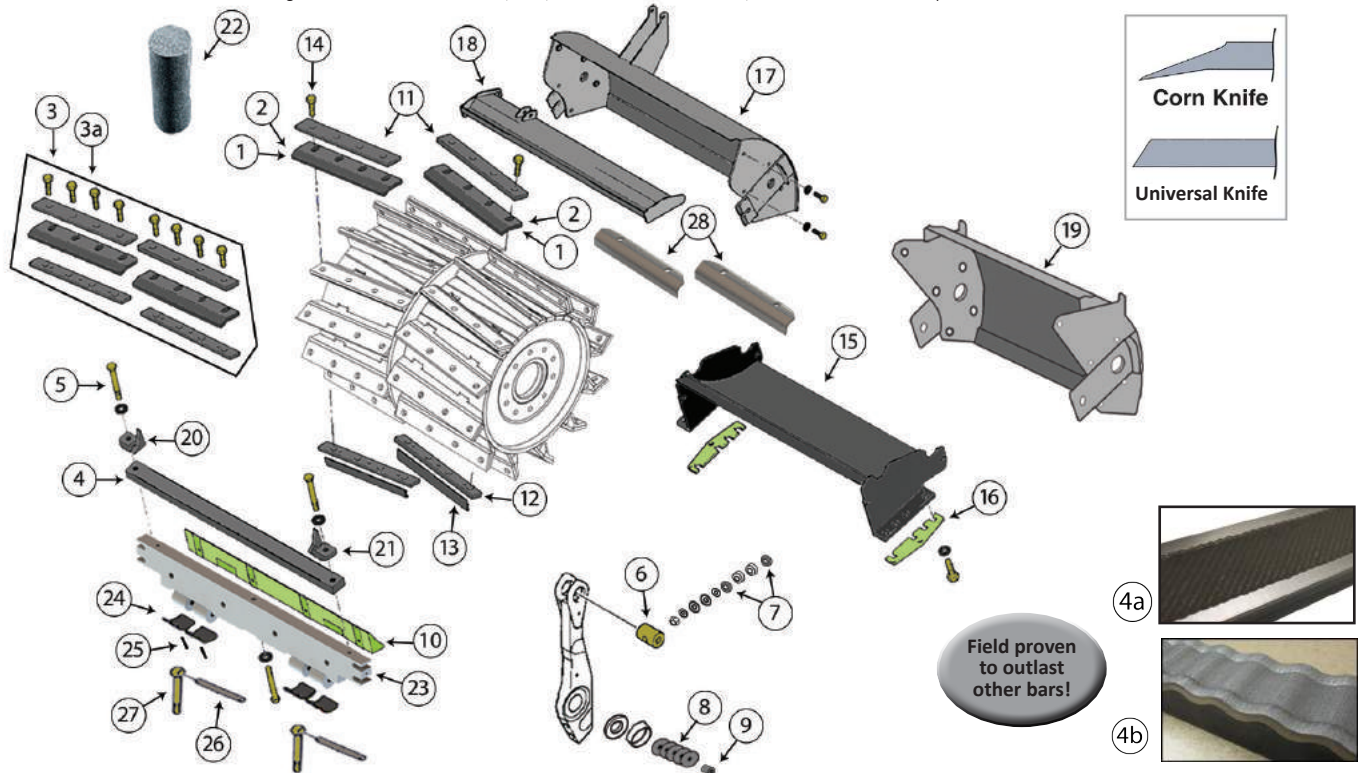



Replacement parts produced by Kooima® Company to fit Claas®

KOOIMA #	DESCRIPTION	REPLACES OEM #
K9846900 (LH) K9846910 (RH) \$27.25 ea.	1 • Corn knife • To fit all 491, 492 & 493 series harvesters • 10 required with 20-knife cylinder, 12 required with 24-knife cylinder • 3.6 lbs.	26201880 / 9981030 / 9846900 26201870 / 9981040 / 9846910 Heat Treated/ Tungsten Carbide
K9846700 (LH) K9846710 (RH) \$26.90 ea.	2 • Universal knife • To fit all 491, 492 & 493 series harvesters • 10 required with 20-knife cylinder, 12 required with 24-knife cylinder • 3.7 lbs. • Universal knife used for corn & grass • Most commonly used	9846700 9846710 Heat Treated/ Tungsten Carbide
K9846700HP (LH) K9846710HP (RH) \$37.10 ea.	2a • Koyma Klad® hi-performance universal knife • To fit all 491, 492 & 493 series harvesters • 10 required with 20-knife cylinder, 12 required with 24-knife cylinder • 3.7 lbs	9846700 9846700 Heat Treated/ Tungsten Carbide
KCORNKIT \$100.40 ea.	3 • Buy (1) LH K9846900, (1) RH K9846910, (2) K9846720, (2) K9846751, (8) K2152120 • Buy any quantity and save! • 15.72 lbs.	
KGRASSKIT \$99.70 ea.	3a • Buy (1) LH K9846700, (1) RH K9846710, (2) K9846720, (2) K9846751, (8) K2152120 • Buy any quantity and save! • 15.92 lbs.	
K9846941HP \$715.00 ea.	4 • High performance shearbar • For use in hay or corn • 22.3 lbs. • To fit all Claas® 491 - 497 series	4952743 / 9846942 Heat Treated/Tungsten Carbide
K900SHBR \$940.00 ea.	4a • Koyma Klad® hi-performance shearbar • For use in hay or corn • To fit all 491 - 497 series • Special chip-free hi-density coating • 23 lbs.	Heat Treated Tungsten Carbide
K494DSW \$1,250.00 ea.	4b • Koyma Klad® hi-performance double sine wave shearbar • Patent # 8,109,176 • To fit all 491 - 497 series • Maximize your shear bars cutting surface • Koyma Klad® coating maintains a long lasting sharp edge for more tons per hour • 20.3 lbs.	26142700 / 4952732
K4952732 \$540.00 ea.	4c • Grass shearbar • To fit all 491 - 497 series harvesters • 21.6 lbs.	26032210
K26032210 \$800.00 ea.	4d • Koyma Klad® hi-performance shearbar • For use in hay or corn • To fit 498 series • High density coating • 21.4 lbs. • K26032210BK : \$15.00 ea. - Bolt kit, change bolts every shear bar, torque 300Nm / 221 ft. lbs • 2.45 lbs.	Heat Treated/Tungsten Carbide
K9846941HPBK \$35.35 ea.	5 • Shearbar bolt kit • To fit all 491, 492 & 493 series • 1 kit required • 3.2 lbs.	
K980BK \$40.35 ea.	5a • Shearbar bolt kit • To fit 494 series • 1 kit required • 2 lbs.	
K9847141 \$27.26 ea.	6 • Replacement brass shearbar adjust bushing • 2 required • To fit all 491, 492, 493, 494, 496 & 497 series harvesters • 1.1 lbs.	13905570 / 9847141
K2443130 \$18.33 ea.	7 • Bearing • To fit 491-494 series Claas® harvesters • 4 required	2443130
K2428620 \$2.82 ea.	8 • Belleville washer • To fit 491-494 series Claas® harvesters • 10 required • .07 lbs.	2428620

KOOIMA® REPLACEMENT PARTS TO FIT CLAAS® FORAGE HARVESTERS

Replacement parts produced by Kooima® Company to fit Claas®

KOOIMA #	DESCRIPTION	REPLACES OEM #
K9130140 \$8.95 ea.	⑨ • Bushing • To fit 491-494 series Claas® harvesters • 2 required • .08 lbs.	9130140
K9847051 \$183.30 ea.	⑩ • Cast shearbar wear ledge • To fit all 491, 492 & 493 series harvesters • 28 lbs.	9847051
K9847051BK \$6.25 ea.	⑩a • Cast shearbar wear ledge bolt kit • To fit 491, 492, 493 & 494 series harvesters • .5 lbs.	
K4958370 \$192.70 ea.	⑩b • Cast shearbar wear ledge • Does not have holes on outside edge • To fit 494 series up to SN 49403007 and SN 49403053 to 49403882 • 20.8 lbs.	4958370
K9846720 \$8.25 ea.	⑪ • Top strap • To fit all Claas® 491, 492 & 493 series harvesters • To fit all 800 models & the 900 • 1.5 lbs.	26245940 / 9846722 Heat Treated
K9846751 \$8.93 ea.	⑫ • Nut • To fit all Claas® 491, 492 & 493 series harvesters • 1.8 lbs.	9846752
K9871982 \$12.46 ea.	⑬ • Cutter drum wear plates • Don't let your expensive investment wear out - protect your knife brackets • .8 lbs.	9871982 Abrasion Resistant
K2152120 \$2.10 ea.	⑭ • Knife bolt • To fit all 491, 492 & 493 series harvesters • .24 lbs.	2152120
K9871982BK \$2.10 ea.	⑭a • Knife bolt • .25 lbs. • Extended length to be used with cutter drum wear plates	
K9862810 \$244.40 ea.	⑮ • Drum bottom • New style for more adjustment • 57.2 lbs. • To fit all 491, 492 & 493 series harvesters • Fits SN. 49207133 and below for 492 models	9862812 Abrasion Resistant
K9862810HP	⑮a • Koyma Klad® hi-performance drum bottom • Fits SN. 49207133 and below for 492 models • Tungsten carbide coated plate makes this an excellent replacement for Claas® Mad Jag™ part • To fit all 491, 492 & 493 series harvesters • 59.7 lbs.	9874302 Abrasion Resistant Tungsten Carbide/Heat Treated
K4958321 \$305.50 ea.	⑮b • Drum bottom • To fit all 494 & 496 series harvesters • 65 lbs.	4958321 Abrasion Resistant
K13241440 \$460.60 ea.	⑮c • Drum bottom • To fit 497 series harvesters	13241440 Abrasion Resistant
K14109032 \$507.60 ea.	⑮d • Drum bottom • To fit 498 series harvesters	14109032 Abrasion Resistant
K9844980 K9845340 \$3.76 ea.	⑮ • 20 gauge shim • .15 lbs. • 14 gauge shim • .25 lbs. • Use as required to obtain proper drum clearance • To fit all 491, 492, 493, 494, 496 & 497 series harvesters using adjustable drum bottom	9844980 9845340
K9874042 \$305.50 ea.	⑰ • Cutterhead housing cover • To fit 492, 493, 494, 496 & 497 series Claas® harvesters • 61.1 lbs.	9874043 Abrasion Resistant
K9872902 \$131.60 ea.	⑱ • Cutterhead stone cover • To fit all Claas® 491-497 series harvesters • 12 lbs.	13244240/9872902
K9848906 \$564.00 ea.	⑲ • Cutterhead housing cover • To fit Early 491 series • 60 lbs.	9848906
K4951160 \$69.00 ea.	⑳ • Shearbar guide RH • To fit 493 & 494 series Claas® harvesters • 1.05 lbs.	13128480/ 4951160
K4951170 \$69.00 ea.	㉑ • Shearbar guide LH • To fit all Claas® 493 & 494 series harvesters • 1.05 lbs.	13128470/ 4951170
K9843181 \$72.95 ea.	㉒ • Sharpening stone • To fit all 491, 492 & 493 series harvesters • 5.2 lbs.	9843185 / 9843184 / 9843181
K13124420 \$87.95 ea.	㉒a • Sharpening stone • To fit all 494 series harvesters • 7.3 lbs.	13124424 / 13124420
K9847021 \$1,175.00 ea.	㉓ • Shearbar anvil • 4 grease zerks for easy adjustment • Made from hardened "T1" steel • To fit all 491 & 492 series harvesters • Recommended to change every 1500 cutterhead hours • 85.5 lbs.	9847022 13909901 / 9064340
K9064340 \$1,175.00 ea.	㉓a • Shearbar anvil • Hardened T1 material • 110 lbs. • To fit 494 series • Change every 1500 cutterhead hours	
K9847021BK \$80.45 ea.	㉓b • Bolt kit to fit K9847021 / K9064340 shearbar anvil • One kit required • A REAL MUST WHEN CHANGING ANVIL • 2.4 lbs.	
K9847261 \$27.80 ea.	㉔ • Anvil bushing • To fit 491-494 series Claas® harvesters • 4 required • .3 lbs.	9847261
K2368980 \$0.45 ea.	㉕ • Anvil bushing tension pin • To fit 491-494 series Claas® harvesters • 4 required • .1 lbs.	2368980
K9847111 \$40.35 ea.	㉖ • Shearbar anvil pin • 2 required • To fit 491-494 series • .7 lbs.	9847111
K2126112 \$37.75 ea.	㉗ • Shearbar anvil eye bolt • 2 required • To fit 491-494 series • 1.2 lbs.	2126112
K04844503 (LH) K04844513 (RH) \$74.00 ea.	㉘  • Koyma Klad® universal knife • 5.54 lbs. • Right hand shown • To fit 494, 496 & 497 series harvesters • 10 required with 20-knife cylinder, 12 with 24-knife cylinder	14101721 / 04844503 14101731 / 04844513 Heat Treated/ Tungsten Carbide
K14103051 \$4.25 ea.	㉘a  • Knife bolt • .35 lbs. • To fit Claas® "C" shaped knives	14103051
K1318738 (Inner) K1318915 (Outer) \$8.00 ea.	 • Knife Clamp • .25 lbs. • To fit Claas® 494, 496 & 497 harvesters • 1 of each required per knife	13187381 13189151 Heat Treated

TO ORDER CALL TOLL FREE 1-800-522-8874

KOOIMA® REPLACEMENT PARTS TO FIT CLAAS® FORAGE HARVESTERS

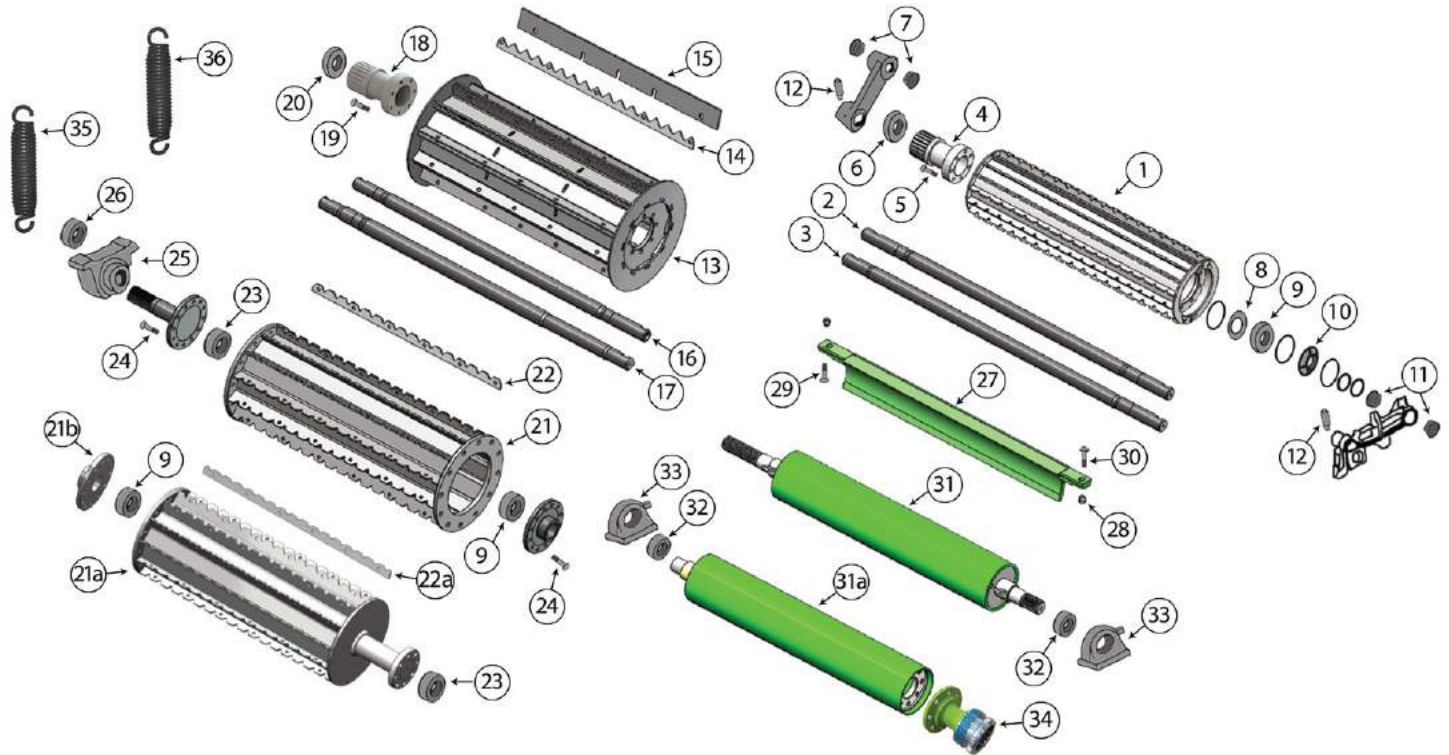

Replacement parts produced by Kooima® Company to fit Claas®

KOOIMA #	DESCRIPTION	REPLACES OEM #
K9979100	• Right inside half knife • To fit all 491, 492 & 493 series harvesters • 3.45 lbs.	9979100 Heat Treated Tungsten Carbide
\$27.30 ea.	• Used for cutting longer silage	
K9979130	• Left inside half knife • To fit all 491, 492 & 493 series harvesters • 3.5 lbs.	9979130 Heat Treated Tungsten Carbide
\$27.30 ea.	• Used for cutting longer silage	
K9979110	• Right outside half knife • To fit all 491, 492 & 493 series harvesters • 3.45 lbs.	9979110 Heat Treated Tungsten Carbide
\$27.30 ea.	• Used for cutting longer silage	
K9979120	• Left outside half knife • To fit all 491, 492 & 493 series harvesters • 3.45 lbs.	4956740 / 9979120 Heat Treated Tungsten Carbide
\$27.30 ea.	• Used for cutting longer silage	



KOOIMA #	DESCRIPTION	REPLACES OEM #
K9862650 (1)	• Upper rear feed roll • Uses M10 bolts • To fit all Claas® 491 & 492 series • 46.8 lbs.	9862651 Stainless Steel
\$1,475.00 ea.		
K9844214 (2)	• Upper rear feed roll shaft • 18.5 lbs.	9844214
\$338.40 ea.	• To fit Claas® 492 series	Heat Treated
K4951732 (3)	• Upper rear feed roll shaft • 19.4 lbs.	4951732
\$296.10 ea.	• To fit Claas® 494, 496 & 497 series	Heat Treated
K9844490 (4)	• Upper rear drive hub • Uses M10 bolts • To fit 491 & 492 series • 1 required • 7.4 lbs.	9844490
\$310.00 ea.		
K2339661 (5)	• Drive hub bolt (M10) • Use with K9844490 drive hub • 8 required	2339661
\$0.90 ea.		
K2114500 (6)	• Drive hub seal • Use with K9844490 drive hub • 1 required • .02 lbs.	2114500
\$10.34 ea.		
K0085430 (7)	• Lift arm bushing • To fit 491-497 series • 4 required • .01 lbs.	0085430
\$3.35 ea.		
K1782720 (8)	• Nylon bearing cover • To fit 492-497 series • 1 required • .02 lbs.	1782720
\$4.00 ea.		
K2122260 (9)	• Upper rear & lower front bearing • To fit 491-497 series • 1 required • .62 lbs.	2122260
\$12.69 ea.		
K9844360 (10)	• LH roller ring • To fit 491-494 series • 1 required • .30 lbs.	9844360
\$35.00 ea.		
K0085600 (11)	• Left hand lift arm bushing • To fit 491-497 series • 2 required • .02 lbs.	0085600
\$3.76 ea.		
K9071323 (12)	• Lift arm key • To fit 491-497 series • 4 required • .18 lbs.	9071323
\$25.85 ea.		
K9856280 (13)	• Upper front feed roll w/o teeth • To fit Claas® 492 and 496 series • 73.8 lbs.	9856282
\$1,927.00 ea.		
K9862571 (14a)	• Upper front feed roll tooth • To fit 491 series Claas® harvesters • 10 required • 1 lb.	9862570 Stainless Steel
\$27.73 ea.		
Bolt Kit: K9862571BK - Kit includes 50 of each stainless steel bolts, washers & nuts- \$51.10		2137151, 2137160, 2137170

KOOIMA® REPLACEMENT PARTS TO FIT CLAAS® FORAGE HARVESTERS

KOOIMA #	DESCRIPTION	REPLACES OEM #
K9879780 \$46.35 ea.	(14b) • Upper front feed roll tooth • To fit Claas® 492, 493 & 494 series • 10 required • 2.2 lbs. • Bolt Kit: K9879780BK - Kit includes 50 (m10 x 30) bolts and nuts • 4.2 lbs. \$79.00 ea. • Use bolt kit K10712121BK for grass option set up M10x50mm \$95.00 ea.	9879780 Stainless Steel
K13247000 \$56.40 ea.	(14c) • Upper front feed roll tooth to fit Claas 497 & 498 series • 2.1 lbs. • Use bolt kit K9879780BK for standard setup M10X30mm \$79.00 ea. • Use bolt kit K10712101BK for grass option set up M10X40mm \$75.45 ea.	13247000
K9845000 \$40.35 ea.	(15) • Upper front flat feed roll tooth • To fit Claas® 492, 493 & 494 series • 10 required • 4 lbs. • A real must when doing earlage • Uses K9879780BK bolt kit	9879780 Stainless Steel
K9864130 \$404.20 ea.	(16) • Upper front feed roll shaft • 18.5 lbs. • To fit Claas® 492 series	9864130 Heat Treated
K4952642 \$338.40 ea.	(17) • Upper front feed roll shaft • 23 lbs. • To fit Claas® 494, 496 & 497 series	4952642 Heat Treated
K9857661 \$545.20 ea.	(18) • Upper front drive hub • To fit all 491, 492 series • 1 required • 7.4 lbs.	9857661
K2154180 \$1.90 ea.	(19) • Drive hub bolt • Use with K9857661 drive hub • 8 required	2154180
K2148210 \$16.54 ea.	(20) • Drive hub seal • Use with K9857661 drive hub • 1 required • .02 lbs.	2148210
K9843466 \$2,608.50 ea.	(21) • Lower front feed roll • To fit Claas® 491 & 492 series • 60 lbs.	9843466 Stainless Steel
K13248680 Call for Availability	(21a) • Lower front feed roll - must order K1312225 flange when updating from 13185402 roll • To fit Claas® 493 & 494 series • 68 lbs. • Flange uses hex screws to assemble flange	1318540 / 1324868 Stainless Steel
NEW! K13122250 \$375.00 ea.	(21b) • Lower front feed roll flange - Use with K13248680 feed roll • To fit Claas® 493 & 494 series • Hardware kit K2173630BK , includes 12 M10x20 hex head bolts	13122250
K9862671 \$39.35 ea.	(22) • Lower front feed roll tooth • .95 lbs. • 25.06" long • To fit all 491, 492 & 493 series Claas® harvesters • 12 required	13125901/9862671 Stainless Steel
K13125901 \$42.30 ea.	(22a) • Lower front feed roll tooth • 1.7 lbs. • 26.66" long • To fit 492, 493, 494 & 496 series Claas® harvesters • 12 required	13125901 Stainless Steel
K13248740 \$47.00 ea.	(22b) • Lower front feed roll tooth • 1.7 lbs. • 26.25" long • 12 required • To fit 497 & 498 series Claas® harvesters • Bolt Kit K13248740BK - \$100.75 ea.	26011510 Stainless Steel
K9862671BK \$77.00 ea.	(22c) • Feed roll tooth bolt kit • To fit all Claas® 491, 492, 493, 494 & 496 series • Each kit has 72 stainless steel bolts, washers and nuts • 3 lbs.	Stainless Steel
K2377130 \$5.88 ea.	(23) • Lower front feed roll bearing • .18 lbs. • To fit 491 & 492 series (RH side) To fit 493-497 (LH side) • 1 required	2377130
K2121181 \$3.76 ea.	(24) • Drive hub bolt • To fit 491 & 492 series • 24 required • .04 lbs.	2121181
K2135750 \$108.10 ea.	(25) • RH feed roll housing and bearing • Complete with bearing • To fit 491 & 492 series • 1 required • 4.5 lbs.	2135750
K10032036 \$40.00 ea.	(26) • RH bearing • To fit K2135750 Housing • 1 required • 1.8 lbs.	2164280
K9843393 \$296.10 ea.	(27) • Smooth roll cleaner • To fit all Claas® 491 & 492 series harvesters • To fit 493/494 with slotted hole adjustment • 27.3 lbs.	9843395 
K9843393HP \$545.80 ea.	(27a) • Koyma Klad® hi-performance smooth roll cleaner • To fit all Claas® 491 & 492 series • 26.2 lbs. • To fit 493/494 with slotted hole adjustment • Coating improves life of cleaner and shearbar	9843395 
K13187902 \$338.40 ea.	(27b) • Non slotted smooth roll cleaner • To fit Claas® 493/494/496/497 series • After serial # 49401495	13187902
K13187910 \$18.00 ea.	(28) • Scraper eccentric cam • To fit 493-497 series • 2 required • .22 lbs.	13187910
K2124081 \$2.05 ea.	(29) • RH scraper bolt • To fit 493 & 494 • Use with K13187910 cam • 1 required • .12 lbs.	2124081
K2334110 \$1.93 ea.	(30) • LH scraper bolt • To fit 493 & 494 • Use with K13187910 cam • 1 required • .16 lbs.	2334110
K9844930 \$493.50 ea.	(31) • Lower rear smooth roll • To fit all Claas® 491 & 492 series • 68 lbs.	9844931
K9061530 \$720.00 ea.	(31a) • Lower rear smooth roll • To fit all Claas® 493, 494 & 497 series • 41.17 lbs.	14121050/13902460
K2127180 \$31.49 ea.	(32) • Smooth roll bearing • Used with K9844900 housing • To fit 492-494 series • 2 required	2127180
K9844900 \$90.71 ea.	(33) • Bearing housing (Housing only) • To fit 491-494 series • 2 required • 3.35 lbs.	9844900
K4953380 \$575.00 ea.	(34) • Smooth roll feed roll drive coupler • To fit Claas® 493, 494, 496 & 497 series smooth roll • 7.5 lbs.	4953380
K9820971 \$131.60 ea.	(35) • Feed roll tension spring • To fit 494 & 497 series • 2 required • 7.6 lbs.	9820971
K4952701 \$164.50 ea.	(36) • Upper rear roll tension spring • To fit 493 & 494 series • 4 required • 12.8 lbs.	4952701

Replacement parts produced by Kooima® Company to fit Claas®

Order online at WWW.KOOIMA.COM and receive **FREE FREIGHT** to your door!

KOOIMA®
COMPANY



KOOIMA® REPLACEMENT PARTS TO FIT CLAAS® FORAGE HARVESTERS

Replacement parts produced by Kooima® Company to fit Claas®

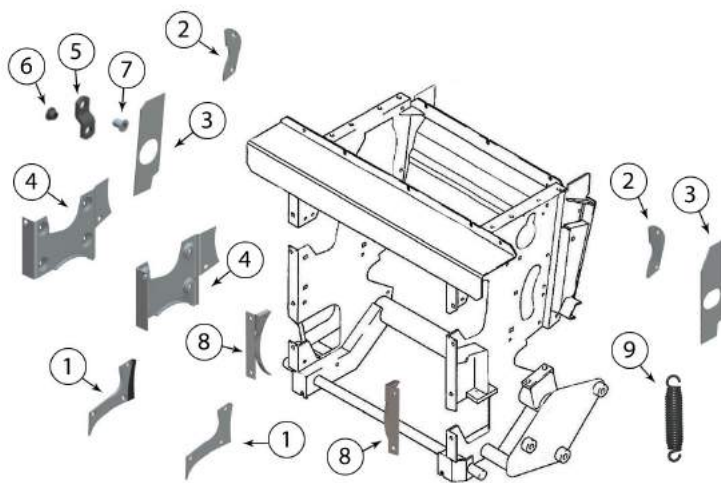

K984602WL
\$150.75 per kit

- Cutterhead housing wear plate kit
- **Not available from Claas®!**
- To fit all 491, 492 & 493 series
- Includes mounting hardware
- 1 kit required
- 12 lbs./set

Abrasion Resistant

KOOIMA #	DESCRIPTION	REPLACES OEM #
K9842504 (LH)	• Feed roll housing wear plate	9842504
K9842484 (RH)	• To fit Claas® 491, 492 & 493 series harvesters	9842484
\$40.42 ea.	• 1.7 lbs. ea.	Abrasion Resistant/Tungsten Carbide
K9842504BK	• Wear plate bolt kit • .5 lbs.	
\$5.25 ea.	• To fit parts K9842504 and K9842484 • 1 kit required per wear plate	
K9842510 (RH)	• Wear plate for upper back feed roll	9842510
K9842520 (LH)	• To fit 491 & 492 series machines	9842520
\$31.02 ea.	• .95 lbs.	Abrasion Resistant
K9842510BK	• Bolt kit • .185 lbs.	
\$3.25 ea.	• 1 kit per wear plate	
K9842580 (RH)	• Slider wear plate	9842580
\$61.10 ea.	• To fit 491 & 492 series machines • 2.3 lbs.	Abrasion Resistant
K9842540 (LH)	• Slider wear plate	9842540
\$28.20 ea.	• To fit 491 & 492 series machines • 2.3 lbs.	Abrasion Resistant
K9874371(RH)	• Lower front feed roll wear plate	9874371
K9874351 (LH)	• To fit 491 & 492 series machines	9874351
\$55.46 ea.	• 6.25 lbs. ea.	Abrasion Resistant
K9874351BK	• Bolt kit • .25 lbs.	
\$9.25 ea.	• For lower front feed roll • 1 kit per wear plate	
K9842610	• Cutter housing lever	9842610
\$29.80 ea.	• To fit 491 & 492 series machines • .3 lbs.	
K9842621	• Cutter housing lever bushing	9842621
\$6.39 ea.	• To fit 491 & 492 series machines • .06 lbs.	Heat Treated
K9879400	• Cutter housing lever bushing	9879400
\$9.40 ea.	• To fit 491 & 492 series machines • .08 lbs.	Heat Treated
K9842670 (RH)	• Wrap guard	9842670
K9842630 (LH)	• To fit 491, 492, 493 & 494 series machines	9842630
\$46.53 ea.	• 1 of each required • 1.86 lbs.	
K2363300	• Wrap guard bolt	2363300
\$0.65 ea.	• To fit K9842670 & K9842630 • 2 required per guard • .03 lbs.	
K9844191	• Tension spring	9844191
\$142.88 ea.	• To fit 491 & 492 series machines • 2 required • 12.5 lbs.	

KOOIMA® REPLACEMENT PARTS TO FIT CLAAS® FORAGE HARVESTERS

Replacement parts produced by Kooima® Company to fit Claas®

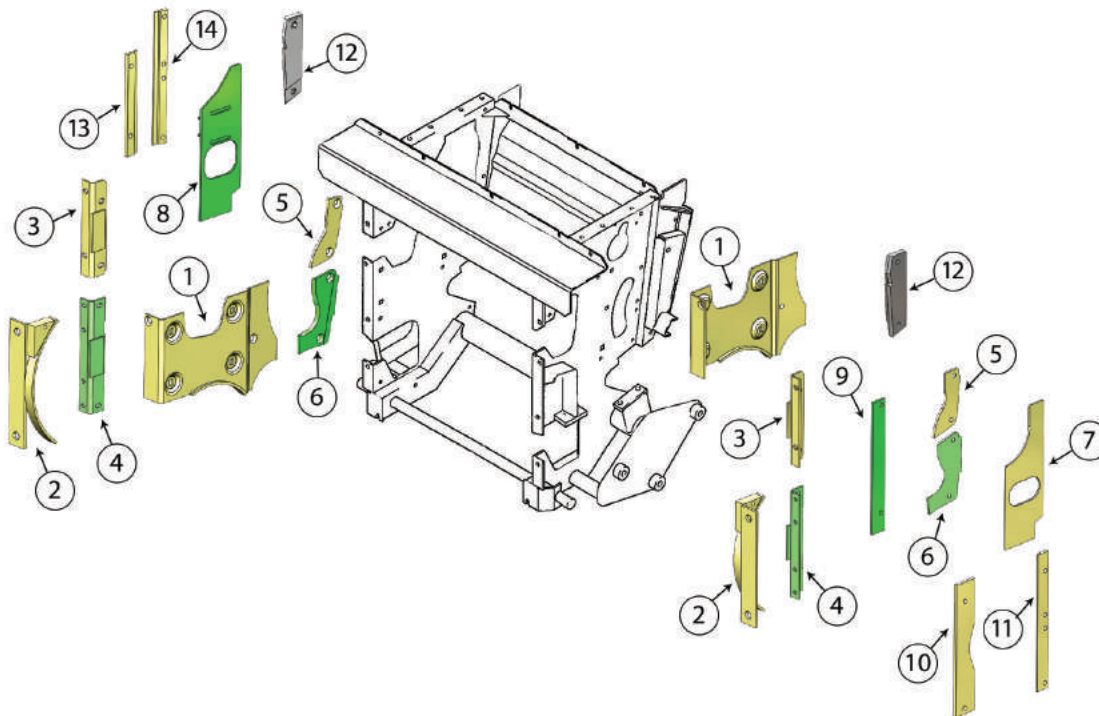

KOOIMA #	DESCRIPTION	REPLACES OEM #
K4951460 (LH) K4951480 (RH) \$55.46 ea.	① • Lower front feed roll wear plate • To fit Claas® 494 series harvesters • 6.75 lbs. ea.	4951460 4951480
K9874351BK \$9.25 ea.	①a • Bolt kit • .25 lbs. • For lower front roll wear plate • 1 kit required per wear plate	
K9842670 (LH) K9842630 (RH) \$46.53 ea.	② • Wrap guard • To fit Claas® 494 series harvesters • 1.9 lbs. ea. • 1 of each required	9842670 9842630
K2363300 \$0.65 ea.	②a • Wrap guard bolt • .05 lbs. • To fit K9842670 and K9843630 • 2 required per guard	2363300
K9870650 (LH) K9870670 (RH) \$28.67 ea.	③ • Cutter housing top angled wear plate • To fit Claas® 494 series harvesters • 1.55 lbs.	9870650 9870670
K9842680 (LH/RH) \$46.06 ea.	④ • Cutter housing lower angled wear plate • To fit Claas® 494 series harvesters • 1.8 lbs.	9842680
K9060840 (LH) K9060830 (RH) \$15.75 ea.	⑤ • Cutter housing top segment • To fit Claas® 494 series harvesters • .75 lbs.	9060840 9060830
K13905730 (LH) K13905720 (RH) \$56.40 ea.	⑥ • Cutter housing lower segment • To fit Claas® 494 series harvesters • 1.3 lbs.	Abrasion Resistant 13905730 13905720
K9060890 \$28.91 ea.	⑦ • Left hand slider wear plate • To fit Claas® 494 series harvesters • 2.2 lbs.	Heat Treated 9060890
K9060951 \$70.50 ea.	⑧ • Right hand slider wear plate • To fit Claas® 494 series harvesters • 2.9 lbs.	Abrasion Resistant 9060951
K9060750 \$10.81 ea.	⑨ • Cutter housing left hand bar • To fit Claas® 494 series harvesters • 1.5 lbs.	Abrasion Resistant 9060750
K9060770 \$28.91 ea.	⑩ • Cutter housing left hand glide rail • To fit Claas® 494 series harvesters • 2.6 lbs.	Abrasion Resistant 9060770
K9060850 \$24.91 ea.	⑪ • Cutter housing left hand support • To fit Claas® 494 series harvesters • 1.5 lbs.	9060850
K13184150 (LH) K13184140 (RH) \$18.50 ea.	⑫ • Cutter housing filler plate • To fit Claas® 494 series harvesters • .4 lbs.	13184150 13184140
K9060920 \$19.55 ea.	⑬ • Cutter housing right hand support • 9.82" • To fit Claas® 494 series harvesters • 1.05 lbs.	UHMW 9060920
K9060901 \$24.91 ea.	⑭ • Cutter housing right hand support • 12.78" • To fit Claas® 494 series harvesters • 1.4 lbs.	9060901

Order online at WWW.KOOIMA.COM and receive **FREE FREIGHT** to your door!

KOOIMA
COMPANY



137

KOOIMA® REPLACEMENT PARTS TO FIT CLAAS® FORAGE HARVESTERS

Replacement parts produced by Kooima® Company to fit Claas®

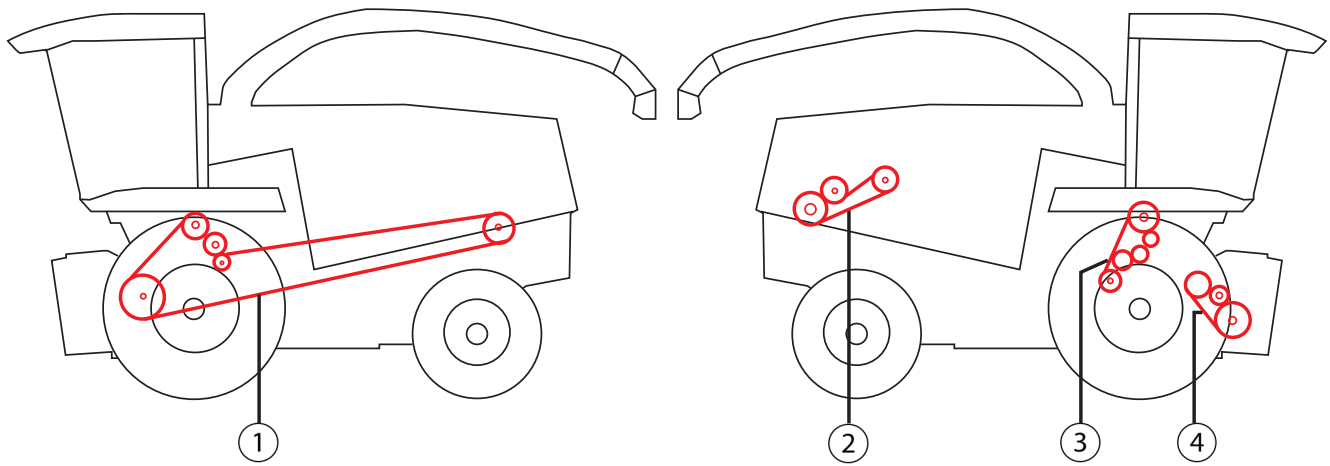

High Quality Gates® Belts

KOOIMA #		DESCRIPTION	REPLACES OEM #
K0677471 \$846.00 ea.	①	• Power band belt, 7-groove • To fit Claas® 492 & 493 models • 34.5 lbs.	0677471
K0677450 \$423.00 ea.	①	• Power band belt, 5-groove • To fit Claas® 492 & 493 models • 24.9 lbs.	0677450
K0677460 \$560.80 ea.	①	• Power band belt, 6-groove • To fit Claas® 492 & 493 models • 29.5 lbs.	0677460
K0902650 \$470.00 ea.	①	• Main drive belt, 5-groove • To fit Claas® 494 models 930 machine • 26.4 lbs.	1319950 / 0902650
K0902660 \$517.00 ea.	①	• Main drive belt, 6-groove • To fit Claas® 494 models 940 machine • 31.9 lbs.	1319960 / 0902660
K0902670 \$810.00 ea.	①	• Main drive belt, 7-groove • To fit Claas® 494 models 950/960 machine • 37.8 lbs.	1319970 / 0902670
K1407560 \$835.80 ea.	①	• Main drive belt, 8-groove • To fit Claas® 494 models 970/980 (2 motor) machine • 44 lbs.	1309990 / 1407560
K0672890 \$50.76 ea.	②	• Alternator belt for OM502LA motor • To fit Claas® 492 & 493 models • .9 lbs.	0672890
K1422320 \$56.40 ea.	②	• Alternator belt for OM460LA motor • To fit Claas® 492 & 493 models • 2 lbs.	1422320
K0774000 \$25.54 ea.	②a	• V-ribbed fan belt for OM460LA, OM457LA motors • To fit Claas® 492 & 493 models	0774000
K0699250 \$26.80 ea.	②a	• V-ribbed fan belt for OM502LA motor • To fit Claas® 492 & 493 models	0699250
K0764031 \$93.06 ea.	③	• Power band belt, 4-groove • To fit Claas® 492 models • 4 lbs.	0764031
K0677890 \$164.50 ea.	③	• Power band belt, 6-groove • To fit Claas® 492 & 493 models • 5.9 lbs.	0677890
K0902550 \$126.90 ea.	③	• Power band belt, 6-groove • To fit Claas® 494 models with roll diameter of 196mm • 6.2 lbs.	0902550
K0902561 \$164.50 ea.	③	• Power band belt, 6-groove • To fit Claas® 494 models with roll diameter of 250mm • 6.4 lbs.	0902561
K9848850 \$98.70 ea.	④	• Power band belt, 3-groove • To fit Claas® 492 models • 3.4 lbs.	9848850
K9878830 \$89.00 ea.	④	• Power band belt, 4-groove • To fit Claas® 492 models • 5 lbs.	9878830
K6297691 \$61.10 ea.	④	• Power band belt, 2-groove • To fit Claas® 493 models & 494: 930-960 only • 2.4 lbs.	6297691
K4950080 \$108.10 ea.	④	• Power belt for feed roll, 3-groove • To fit Claas® 494, 496 & 497 models; mostly 970 & 980 machines • 3.6 lbs.	13242220 / 4950080

KOOIMA® REPLACEMENT PARTS TO FIT CLAAS® FORAGE HARVESTERS

Replacement parts produced by Kooima® Company to fit Claas®

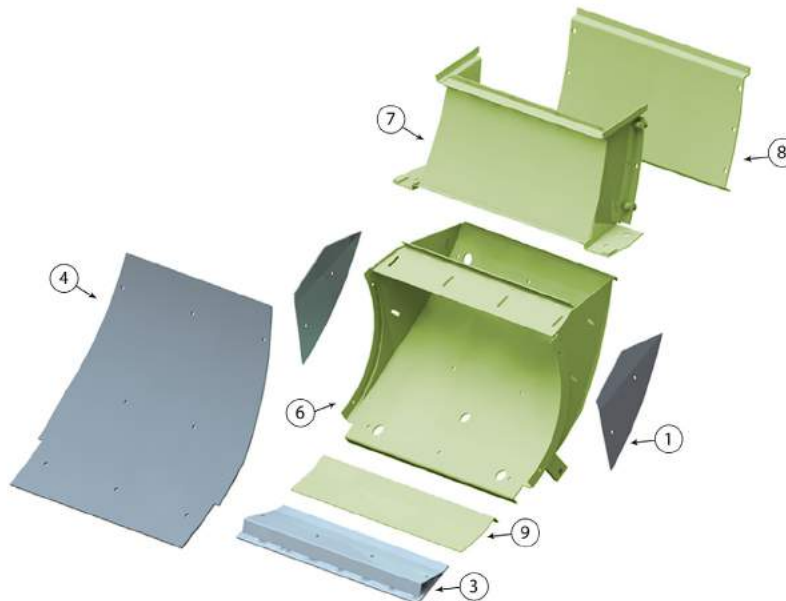

KOOIMA #		DESCRIPTION	REPLACES OEM #
K0763933 (LH)	①	• Filler housing wear plate	0763933
K0763943 (RH)	①a	• To fit all 491, 492 & 493 series Claas® harvesters	0763943
\$21.15 ea.		• 3.4 lbs. ea.	Abrasion Resistant
K1406952 (LH)	①b	• Filler housing wear plate	1406952
K1406942 (RH)	①c	• To fit all 494 series machines	1406942
\$20.21 ea.		• 4.4 lbs. ea.	Abrasion Resistant
K0763933BK	②	• Wear plate bolt kit • 1 kit required per wear plate	
\$4.25 ea.		• To fit all Claas® machines • .1 lbs.	
K0762473	③	• 3 kits required when buying a set of 494 wear plates	0762473
\$56.40 ea.		• Filler housing stripper	
K1406871	③a	• To fit all 491, 492 & 493 series Claas® harvesters • 15.7 lbs.	1406871
\$70.00 ea.		• Filler housing stripper	Abrasion Resistant
K0762182	④	• To fit 494 series Claas® harvesters • 21.75 lbs.	0762182
\$98.00 ea.		• Filler housing wear plate	Abrasion Resistant
K0762182HP	④a	• To fit all 491, 492 & 493 series Claas® harvesters • 61 lbs.	0762182
\$564.00 ea.		• Koyma Klad® hi-performance filler plate	Abrasion Resistant
K1432570	④b	• Tungsten carbide coated plate makes this an excellent replacement for Claas® Mad Jag™ part	1432570
\$153.22 ea.		• To fit all 491, 492 & 493 series Claas® harvesters • 101 lbs.	Tungsten Carbide Heat Treated
K0762182BK	⑤	• Filler housing wear plate • 59.8 lbs.	ABRASION RESISTANT
\$13.00 ea.		• To fit all 494 series Claas® harvesters up to SN# 49402913	
K0762113	⑥	• Wear plate bolt kit • To fit part K0762182 • 1 kit required • .4 lbs.	0909750/0762113
\$258.50 ea.		• To fit all 491, 492, 493 & 494 series Claas® harvesters • Fits all models	Abrasion Resistant
K1406965	⑥a	• Feed guide	1406965
\$244.40 ea.		• To fit all 491, 492 & 493 series Claas® harvesters • 58.4 lbs.	
K1231056	⑥b	• Feed guide	1231058
\$368.05 ea.		• To fit all 494 series Claas® harvesters up to SN# 49402018	
K0788641	⑦	• To fit Claas® 494 SN# 49402914 and after, all 496 & 497 series	0788622
\$220.90 ea.		• Transition/grass chute housing	Abrasion Resistant
K1415261	⑦a	• To fit all 491, 492 & 493 series Claas® harvesters	1415261
\$245.75 ea.		• Bolts are included • 50 lbs.	
K1234121	⑦b	• Transition/grass chute housing	1234122
\$313.55 ea.		• To fit Claas® 494 series up to SN# 49402018 • Bolts are included	
K0788641L	⑧	• Transition/grass chute housing • Bolts are included	0788642
\$74.73 ea.		• To fit Claas® 494 SN# 49402914 and after, all 496, 497 & 498 series	Abrasion Resistant
K1415240	⑧a	• Transition/grass chute liner	1415241
\$87.45 ea.		• To fit all 491, 492 & 493 series Claas® harvesters • 1 required • 23.1 lbs.	Abrasion Resistant
K1234002	⑧b	• Transition/grass chute liner • 23.5 lbs.	1234002
\$121.97 ea.		• To fit Claas® 494 series up to SN# 49402913 • 1 required	Abrasion Resistant
K6088190	⑧c	• Transition/grass chute liner	6088190
\$13.70 ea.		• To fit Claas® 494 SN# 49402914 and after, all 496, 497 & 498 series	
K6012430	⑧d	• Locking pin, used with OEM style one turn lock • 4 required	6012430
\$1.70 ea.		• Used with 491-497 transition / grass chute liner	
K1432580	⑨	• Support washer • 4 required	1432580
\$29.50 ea.		• Used with K6088190 locking pin	
		• Transition guide plate	
		• To fit Claas® 494, 496 & 497 series • 6.5 lbs.	

Order online at WWW.KOOIMA.COM and receive FREE FREIGHT to your door!



KOOIMA® REPLACEMENT PARTS TO FIT CLAAS® FORAGE HARVESTERS

Replacement parts produced by Kooima® Company to fit Claas®

KOOIMA #
K1400500



DESCRIPTION

- Replacement blower assembly • 186 lbs. 
- Removable shaft, improved from OEM, designed to resist fatigue
- To fit most 492, all 493 & 494 series cutters in-between model numbers 930-960
- Will fit 491 & 492 series with special bearing kit - **see below for details!**
- Complete with all the paddles and hardware

REPLACES OEM #
1400505

\$1,800.00

K1400500KIT

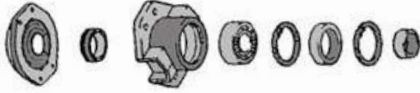

- Replacement bearing assembly
- Update your 491 & 492 series with our blower assembly
- For machines with SN. 49205287 & below
- Also works with 493 & 494 series • 19.5 lbs.

\$850.80

K0676060



- Processor pulley
- Taper lock hub included
- Needed when updating your 491 & 492 machines
- For machines with SN 49205287 & below • 40.2 lbs.

0676061

\$495.80 ea.

K0781810

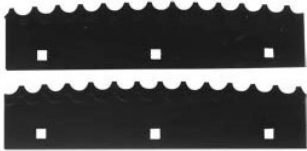

- Accelerator paddle set
- To fit all 491, 492, 493 & 494 series Claas® harvesters
- 4 left and 4 right
- **New wider tooth pattern**
- 13.5 lbs./set

0781810

**High Carbon Steel
Tungsten Carbide
Heat Treated**

\$116.75 per set of 8

K0781810HP

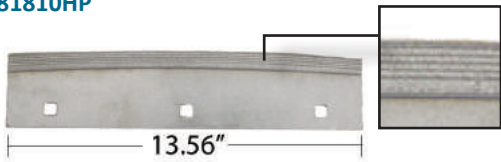

- High performance accelerator paddle set
- 8 paddles per set
- Keeps the blower housing cleaner
- **Koyma Klad® coating**
- Provides up to 15% more air volume, giving more material velocity at the spout tip
- To fit all 491, 492, 493 & 494 series Claas® harvesters
- 23 lbs./set

0781810

**High Carbon Steel
Tungsten Carbide
Heat Treated**

\$193.75 per set of 8

K1238530

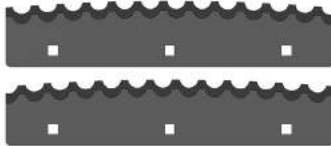

- Accelerator paddle set
- To fit 496, 497 & 498 series
- 4 left and 4 right paddles
- 15% thicker than OEM - improved wider tooth pattern

1238530

**Laser Clad Tungsten Carbide
Heat Treated High Carbon Steel**

\$350.80 per set of 8

K1238660

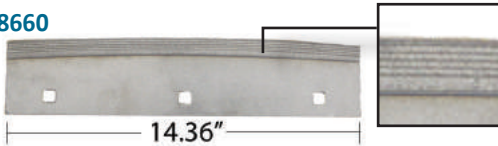

- High performance accelerator paddle set
- **Koyma Klad® coating**
- To fit Claas® 496, 497 & 498 series
- 25 lbs. /set
- Use K0781810BK bolt kit

1238660

**High Carbon Steel
Tungsten Carbide
Heat Treated**

\$375.80 per set of 8

K0781810BK



- Accelerator paddle bolt kit • 1 kit required per paddle set • 2 lbs.
- To fit parts K0781810, K0781810HP, K1238530 & K1238660
- To fit all 491, 492, 493, 494, 496, 497 & 498 series Claas® harvesters

\$39.35 ea.

K0786602

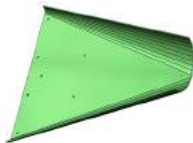

- Transition wear plate • 34 lbs.
- Front 1/2
- To fit all 491, 492, 493, 494, 496 & 497 series Claas® harvesters
- **K0786602BK - Bolt Kit for K0786602 - 1 lb. \$9.25 ea.**

0786603

Abrasion Resistant

\$81.00 ea.

K0786611



- Transition wear plate • 33.4 lbs.
- Rear 1/2
- To fit all 491, 492, 493 & 494 series Claas® harvesters
- **K0786611BK - Bolt Kit for K0786611 - 1 lb. \$9.25 ea.**

0786611

Abrasion Resistant

\$81.00 ea.

K984410SP



- Upper feed roll stop • 1 required
- To fit 491 series Claas® harvesters
- Prevents upper feed roll gear box from breaking the angle lever that holds it in place • 3 lbs.

\$60.45 ea.

KOOIMA® REPLACEMENT PARTS TO FIT CLAAS® FORAGE HARVESTERS

Replacement parts produced by Kooima® Company to fit Claas®

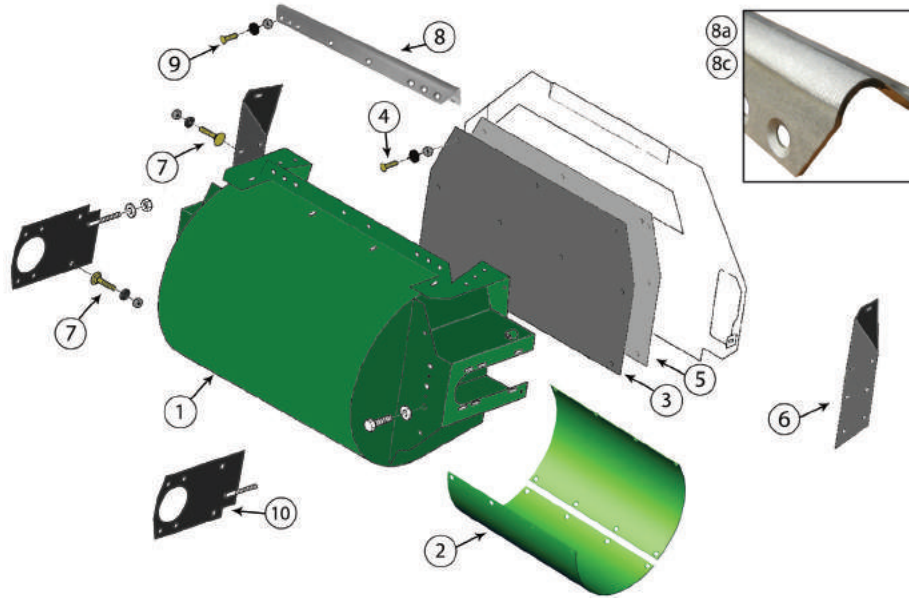

KOOIMA #	DESCRIPTION	REPLACES OEM #
K0784970 \$958.80 ea.	① Accelerator housing • To fit all 491, 492 & 493 series Claas® harvesters • 134 lbs.	0784974 Abrasion Resistant
K0784970WL \$225.75 ea.	② Accelerator housing wear plate kit • To fit all 491, 492 & 493 series Claas® harvesters • Increases the life of accelerator housing • Complete with mounting hardware • 46 lbs.	Abrasion Resistant
K0762023 \$81.78 ea.	③ Wear plate, accelerator housing • To fit all 491, 492 & 493 series Claas® harvesters • 24.4 lbs.	0762024 Abrasion Resistant
K0762023HP \$564.00 ea.	③a Koyma Klad® hi-performance accelerator wear plate • Tungsten carbide coated plate makes this an excellent replacement for Claas® Mad Jag™ part • To fit all 491, 492 & 493 series harvesters • 26.7 lbs.	0762024 Abrasion Resistant Tungsten Carbide Heat Treated
K1417001 \$96.82 ea.	③b Wear plate accelerator housing liner • To fit all 494, 496 & 497 series Claas® harvesters • 24.2 lbs.	1417001
K0762023BK \$15.30 ea.	④ Accelerator bolt kit • To fit wear plate K0762023 • 1 kit required • .55 lbs.	
K0762081 \$50.35 ea.	⑤ Rubber flange • To fit 491, 492 & 493 series Claas® harvesters • 1 required • 4.5 lbs.	0762082
K0763911 (Left) K0763921 (Right) \$24.44 ea.	⑥ Wear plate, accelerator housing • To fit all 491, 492, 493, 494, 496 & 497 series Claas® harvesters • 4.8 lbs. ea.	0763912 0763922 Abrasion Resistant
K0763911BK \$8.50 ea.	⑦ Wear plate bolt kit • To fit part K0763911 or K0763921 • Also fits K0783260 below • 1 kit required per wear plate • .3 lbs.	
K0677972 \$35.25 ea.	⑧ Wear ledge, blower discharge chute • 7.6 lbs. • To fit 491 - 494 series Claas® harvesters • Replaces K0762042	0677973
K0677972HP \$211.97 ea.	⑧a Koyma Klad® hi-performance wear ledge • 8 lbs. • To fit 491 - 494 series Claas® harvesters • Hard faced wear area	1302552 Tungsten Carbide
K1253453 \$37.50 ea.	⑧b Wear ledge, blower discharge chute • To fit Claas® 496, 497 & 498 series harvesters	1253453
K1253453HP \$223.25 ea.	⑧c Koyma Klad® hi-performance wear ledge • To fit Claas® 496, 497 & 498 series harvesters • Hard faced wear area	1253233 / 1253453 Tungsten Carbide
K0762042BK \$29.80 ea.	⑨ Wear plate bolt kit • To fit part K0677972 & K0677972HP • To fit 491 - 494 series Claas® harvesters • 1 kit required per wear plate • .65 lbs.	
K1253453BK \$5.00 ea.	⑨a Wear plate bolt kit • To fit part K1253453 & K1253453HP • To fit 496, 497 & 498 series Claas® harvesters • 1 kit required per wear plate • .2 lbs.	
K0783260 \$54.05 ea.	⑩ Replacement Claas® rotor adjustment plate • 2.2 lbs. • 2 required • Bolt kit available: K0763911BK: \$8.50 ea. , .3 lbs.	0783260

TO ORDER CALL TOLL FREE 1-800-522-8874



KOOIMA® REPLACEMENT PARTS TO FIT CLAAS® FORAGE HARVESTERS

Replacement parts produced by Kooima® Company to fit Claas®

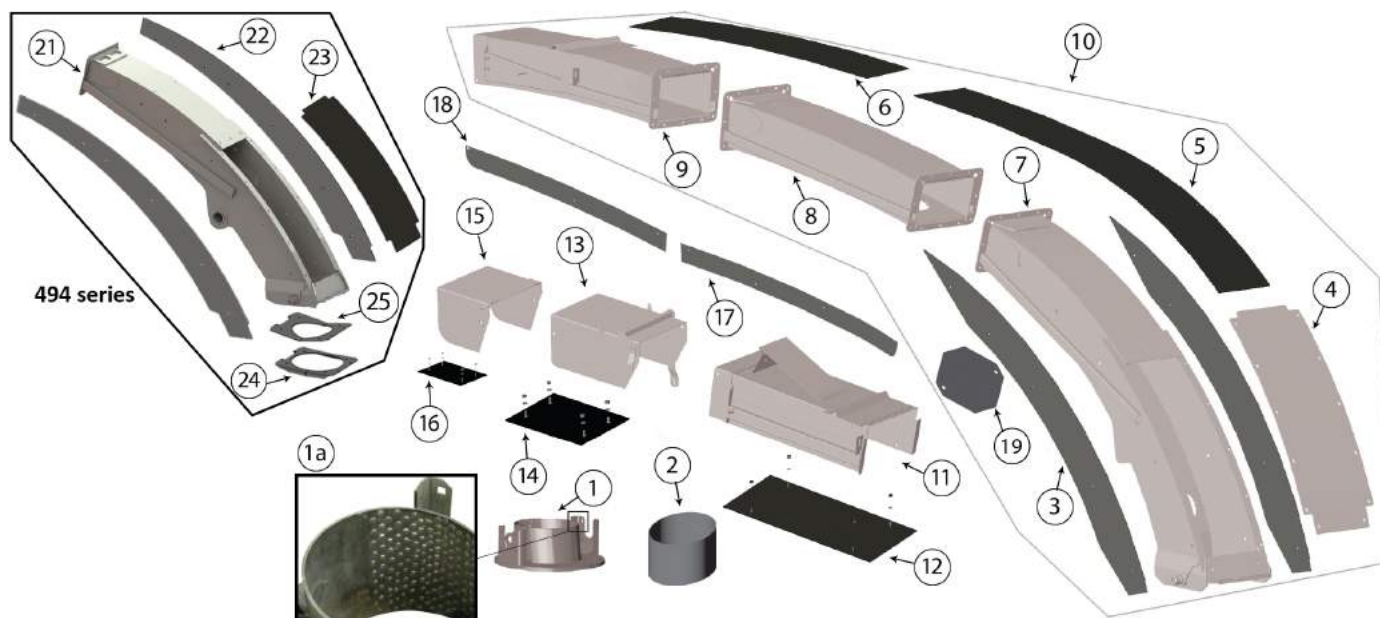

KOOIMA #	DESCRIPTION	REPLACES OEM #
K0762321 \$360.80 ea.	① • Discharge spout swivel flange • Includes replacement spout swivel tube • Now fits 491, 492 & 493 series • 46 lbs.	0684693 / 0762321 Abrasion Resistant
K0762321HP \$475.80 ea.	①a • Koyma Klad® discharge spout swivel flange • To fit 491, 492 & 493 harvesters • We added extended life hard-face inside the swivel tube • 46.5 lbs.	0684693 / 0762321 Abrasion Resistant
K0762321WL \$45.35 ea.	② • Replacement spout swivel tube • Grinding will be required to install • To fit 491, 492 & 493 series • 12.3 lbs.	Abrasion Resistant
K0766353 \$74.26 ea.	③ • Spout side liner • 2 required • To fit all 491, 492, 493 & 494 series with factory spout • 16.8 lbs.	0766354 Abrasion Resistant
K0766353BK \$6.25 ea.	③a • Bolt kit • To fit Claas® liner #K0766353 • .3 lbs.	
K0786770 \$79.00 ea.	④ • Lower rear spout liner • 1 required • Fits Kooima® spouts • 39 lbs. • To fit 491 series Claas® harvesters with 3-piece factory spout	0786770 Abrasion Resistant
K0682380BK \$6.75 ea.	④a • Bolt kit • To fit Claas® liner #K0786770 • 1 lbs.	
K0682380 \$98.70 ea.	④b • Lower rear spout liner • 1 required • 37 lbs. • To fit 492, 493 & 494 series Claas® harvesters	0682382 Abrasion Resistant
K0682380BK \$6.75 ea.	④c • Bolt kit • To fit Claas® liner #K0682380 • 1 lbs.	
K0766462 \$74.26 ea.	⑤ • Middle rear spout liner • 1 required • 32 lbs. • To fit all 491, 492, 493 & 494 series with 3-piece factory spout	0766463 Abrasion Resistant
K0766462BK \$6.25 ea.	⑤a • Bolt kit • To fit Claas® liner #K0766462 • .3 lbs.	
K0786730 \$74.26 ea.	⑥ • Top rear spout liner • 1 required • 21 lbs. • To fit all 491, 492, 493 & 494 series with 3-piece factory spout	0786731 Abrasion Resistant
K0786730BK \$6.25 ea.	⑥a • Bolt kit • To fit Claas® liner #K0786730 • .2 lbs.	
K0682530 \$820.80 ea.	⑦ • Lower spout section • 212 lbs. • To fit 491, 492 & 493 Claas® harvesters with 3-piece hi-arch spout assembly	0682533 / 0682530
K0786470 \$272.60 ea.	⑧ • Middle spout section • 76.5 lbs. • To fit all 491, 492 & 493 series with 3-piece hi-arch spout assembly	0786473
K0786530 \$296.10 ea.	⑨ • Upper spout section • 51.5 lbs. • To fit all 491, 492 & 493 series with 3-piece hi-arch spout assembly	0786531

Truck icon signifies product is shipped via truck freight.

FREE FREIGHT ON RETAIL ORDERS OVER \$750.00!

KOOIMA® REPLACEMENT PARTS TO FIT CLAAS® FORAGE HARVESTERS

KOOIMA #	DESCRIPTION	REPLACES OEM #
K0682520 \$2,570.00 ea.	 <ul style="list-style-type: none"> • Hi-arch spout assembly • 500 lbs. • Complete with abrasion resistant wear liners • Fits all 491, 492 & 493 series Claas® harvesters 	0682520 Abrasion Resistant
K0768980 \$385.00 ea.	<ul style="list-style-type: none"> • 24" spout extension • A real must when using 8-row corn heads • Fits Claas® 491, 492 & 493 series harvesters • 28.5 lbs. 	0768980 Abrasion Resistant
K0768980BK \$6.25 ea.	<ul style="list-style-type: none"> • Spout extension bolt kit • To fit #K0768980 spout extension • .2 lbs. 	
K0681480 \$49.82 ea.	<ul style="list-style-type: none"> • Mid extension spout liner • To fit K0768980 extension • 9.9 lbs. 	0681480 Abrasion Resistant
KBK \$3.25 ea.	<ul style="list-style-type: none"> • Spout extension bolt kit • To fit #K0681480 spout liner • .1 lbs. 	
K0766286 \$89.30 ea.	<ul style="list-style-type: none"> • Inner spout deflector • 20 lbs. • To fit all 491, 492 & 493 series Claas® harvesters 	0788020 Abrasion Resistant
K0766312BK \$6.25 ea.	<ul style="list-style-type: none"> • Inner spout deflector bolt kit • To fit #K0766286 spout deflector • .2 lbs. 	
K0684310 \$44.65 ea.	<ul style="list-style-type: none"> • Spout deflector wear plate • To fit #K0766286 inner spout deflector • 8.3 lbs. 	0684310 Abrasion Resistant
KBK \$3.25 ea.	<ul style="list-style-type: none"> • Spout extension bolt kit • To fit #K0684310 spout deflector wear plate • .1 lbs. 	
K0766312 \$74.26 ea.	<ul style="list-style-type: none"> • Outer spout deflector • 10.4 lbs. • To fit all 491, 492, 493, 494, 496 & 497 series Claas® harvesters 	0766314 Abrasion Resistant
K0766312BK \$6.25 ea.	<ul style="list-style-type: none"> • Outer spout deflector bolt kit • To fit #K0766312 spout deflector • .2 lbs. 	
K0766312WL \$35.35 ea.	<ul style="list-style-type: none"> • Spout deflector wear plate • To fit #K0766312 outer spout deflector • 3.5 lbs. 	Abrasion Resistant
KBK \$3.25 ea.	<ul style="list-style-type: none"> • Spout extension bolt kit • To fit #K0766312WL spout deflector wear plate • .1 lbs. 	
K0786469 \$70.45 ea.	<ul style="list-style-type: none"> • Mid-section spout side liner • 2 required • Kooima® exclusive will need to drill mounting holes • Fits all 491, 492 & 493 series with 3-piece factory spout • 3.7 lbs. 	Stainless Steel
K0786469BK \$6.25 ea.	<ul style="list-style-type: none"> • Mid-section spout side liner bolt kit • To fit #K0786469 spout side liner • 2 required • .25 lbs. 	
K0786529 \$70.45 ea.	<ul style="list-style-type: none"> • Upper section spout side liner • 2 required • Kooima® exclusive will need to drill mounting holes • Fits all 491, 492 & 493 series with 3-piece factory spout • 2.9 lbs. 	Stainless Steel
K0786529BK \$6.25 ea.	<ul style="list-style-type: none"> • Upper section spout side liner bolt kit • To fit #K0786529 spout side liner • 2 required • .25 lbs. 	
K0766481 \$7.25 ea.	<ul style="list-style-type: none"> • Spout inspection door • 5 required • 1 lb. 	0766481

Improved Design!
Extra Support! Stronger Flanges!

Replacement parts produced by Kooima® Company to fit Claas®

KOOIMA 3 PIECE SPOUT TO FIT CLAAS® 494 SERIES FORAGE HARVESTERS

Change out these pieces to use your 491, 492 and 493 series spout on a 494 series

KOOIMA #	DESCRIPTION	REPLACES OEM #
K01417525 \$1,500.00 ea.	 <ul style="list-style-type: none"> • Lower spout section • To fit 494 series • 185.5 lbs. 	01405201/01417525
K1417742 \$117.50 ea.	<ul style="list-style-type: none"> • Side liner • 2 required • To fit 494, 496 & 497 series • 19.3 lbs. 	1417743 Abrasion Resistant
K1417742BK \$5.25 ea.	<ul style="list-style-type: none"> • Bolt kit • To fit liner #K1417742 • .45 lbs. 	
K0786770 \$79.00 ea.	<ul style="list-style-type: none"> • Lower rear spout liner • Fits Kooima® spouts • 39 lbs. • To fit 494 series Claas® harvesters with 3-piece factory spout 	0786770 Abrasion Resistant
K0682380BK \$6.75 ea.	<ul style="list-style-type: none"> • Bolt kit • To fit liner #K0786770 • 1 lbs. 	
K1416781 \$43.35 ea.	<ul style="list-style-type: none"> • U-Beam • To fit Claas® 494, 496 & 497 spouts • 3.7 lbs. 	1416782 / 1416781
K1416790 \$19.30 ea.	<ul style="list-style-type: none"> • Gasket • To fit Claas® 494, 496, 497 & 498 spouts • .7 lbs. 	1416790



KOOIMA® REPLACEMENT PARTS TO FIT CLAAS® FORAGE HARVESTERS

494 Series

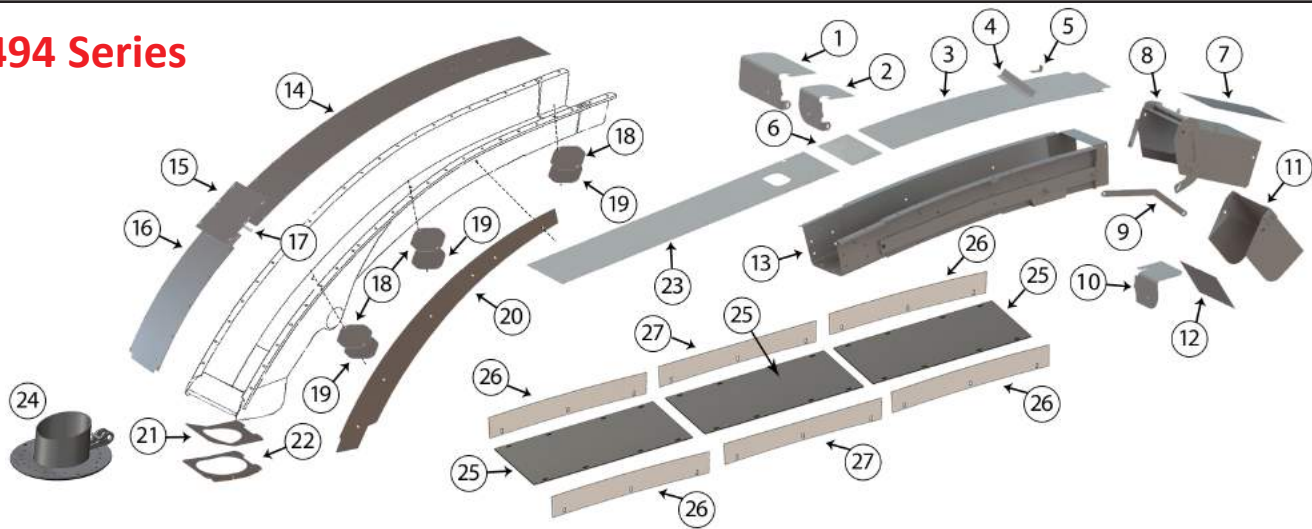

KOOIMA #		DESCRIPTION	REPLACES OEM #
K1431721	①	• Support RH • To fit Claas® 494 spouts • 4.3 lbs.	1431721
K1417861	②	• Support RH • To fit Claas® 494 spouts • 2.6 lbs.	1417862
K1416840	③	• Wear plate • To fit Claas® 494, 496 & 497 spouts • 29.6 lbs.	1416840 Abrasion Resistant
K1437901	④	• Bale chamber support • To fit Claas® 494, 496 & 497 spouts • 1.7 lbs.	1437901
K1431730	⑤	• Angle • To fit Claas® 494, 496 & 497 spouts • .3 lbs.	1431730
K1417890	⑥	• Plate • To fit Claas® 494, 496 & 497 spouts • 4 lbs.	1417890 Abrasion Resistant
K1445030	⑥a	• Replacement Claas® HD spout plate • Only used with Claas® moisture sensor • 4 lbs.	1445031
K1435090	⑦	• Wear plate • Bolt kit: KBK, \$3.25 ea. • To fit Claas® 494, 496 & 497 spouts • 8 lbs.	1435090 Abrasion Resistant
K1409621	⑧	• Inner deflector • Bolt kit: K0766312BK, \$6.25 ea. • To fit Claas® 494, 496 & 497 spouts • 20.8 lbs.	1409622
K1419110	⑨	• Strap • To fit Claas® 494, 496 & 497 spouts • 2.1 lbs.	1419110
K1417871	⑩	• Support LH • To fit Claas® 494 spouts • 2.6 lbs.	1417871
K0766312	⑪	• Outer spout deflector • To fit Claas® 494, 496 & 497 spouts • 10.4 lbs.	0766314 Abrasion Resistant
K0766312BK	⑪a	• Outer spout deflector bolt kit • To fit #K0766312 spout deflector • .2 lbs.	
K0766312WL	⑫	• Spout deflector wear plate • To fit #K0766312 outer spout deflector • 3.5 lbs.	Abrasion Resistant
KBK	⑫a	• Spout extension bolt kit • To fit #K0766312WL spout deflector wear plate • .1 lbs.	
K1417803	⑬	• Upper spout section • To fit Claas® 494, 496 & 497 spouts • 65 lbs.	1417808 Abrasion Resistant
K1417970	⑭	• Middle wear liner • To fit Claas® 494, 496 & 497 spouts • 37.8 lbs.	1417970 Abrasion Resistant
K1417880	⑮	• Plate • To fit Claas® 494, 496 & 497 spouts • 7.6 lbs.	1417880
K1417960	⑯	• Bottom wear liner • To fit Claas® 494, 496 & 497 spouts • 38.8 lbs.	1417960 Abrasion Resistant
K1438590	⑰	• Gasket • To fit Claas® 494, 496 & 497 spouts • .1 lbs.	1438590
K1434940	⑱	• Gasket • To fit Claas® 494 and 496 & 497 (SN. 49700057 & before) spouts • .3 lbs.	1434940
K1434690	⑲	• Cover • To fit Claas® 494 and 496 & 497 (SN. 49700057 & before) spouts • 1.3 lbs.	1434690
K1417742	⑳	• Side liner • 19.3 lbs. • To fit Claas® 494, 496 & 497 spouts • 2 required	1417743 Abrasion Resistant
K1417742BK	⑳a	• Bolt Kit • To fit liner # K1417742 • .34 lbs.	
K1416790	㉑	• Gasket • To fit Claas® 494, 496, 497 & 498 spouts • .7 lbs.	1416790
K1416781	㉒	• U-Beam • To fit Claas® 494, 496 & 497 spouts • 3.7 lbs.	1416781

Replacement parts produced by Kooima® Company to fit Claas®

KOOIMA® REPLACEMENT PARTS TO FIT CLAAS® FORAGE HARVESTERS

Replacement parts produced by Kooima® Company to fit Claas®

KOOIMA #		DESCRIPTION	REPLACES OEM #
K1431812	(23)	• HD liner for moisture sensor	1431812
\$135.00 ea.		• To fit Claas® 494 spouts • 36.2 lbs.	
K1234851	(24)	• Discharge spout swivel flange • Includes swivel tube	1234851
\$435.80 ea.		• To fit 494 series after serial # 49401277 and all 496 & 497 series • 55 lbs.	Abrasion Resistant
K1417850	(25)	• Spout extension wear plate	1417850
\$69.95 ea.		• 3 required • 16.5 lbs.	Abrasion Resistant
K01439670	(26)	• Spout extension inner & outer side liners	1439671 / 1439670
\$29.80 ea.		• 4 required • 2.1 lbs.	Stainless Steel
K1237660	(27)	• Spout extension center side liners	1237660
\$29.80 ea.		• 2 required • 2.1 lbs.	Stainless Steel

Carbon Fiber Spout Extension



CLAASCFSP



300 lb. total weight when shipped

When using large heads the need to keep trucks away from the chopper becomes more important. This 12 row carbon fiber spout extension is what you need to get this done.

This light weight carbon fiber extension helps keep stress off of your spout and helps prevent spout damage while still having the rigidity of a heavier steel version.

- Carbon fiber 12 row spout extension • US PATENT # 9,198,350 & 9,326,445
- Includes sturdy 70" custom steel base, with factory style mounting • All hardware included
- Direct fit for 494+ series • 150 lbs
- Matches factory 12 row arch • Approximately 100 lbs. lighter than factory steel HD 12 extension
- Easy and fast installation, no drilling required • Do not install on worn or damaged spout base
- Uses OEM style spout deflectors • 1 piece liner: **FH5001128**

\$4,750.00 ea.

FH5001128
\$260.75 ea.

- Replacement carbon fiber spout extension center liner
- High wear UHMW plastic • 14 lbs.



The Rock Stop'er Pro FORAGE HARVESTER STONE DETECTION SYSTEM

Fits many makes and models of self propelled and now pull type forage harvesters. Patented and proven Inertia Sensor senses sudden displacement of front upper feedroll. In-cab sensitivity adjustment enables operator to adjust for varying crop conditions and feedroll speeds. A stone detection will cause the feed drive to stop instantly just like a metal detection.



SENSOR

- Durable cast aluminum
- Moisture resistant sealing
- Strong universal mount, mounts externally in minutes
- Adjust sensitivity in seconds
- Small and light weight.



CONTROL MODULE

- Easily mounts in-cab
- Sensor status indicator
- Audible/ visual detection indicator
- In-cab sensitivity dial



Designed and Manufactured in Canada.

Call **1-800-522-8874** for more details!



Order # ROCK STOP'ER
Only \$**2,950⁰⁰** ea.

Extra Sensor Available!
Order # SENSOR
Only \$**750⁸⁰** ea.

TO ORDER CALL TOLL FREE 1-800-522-8874

KOOIMA
COMPANY



KOOIMA® REPLACEMENT PARTS TO FIT CLAAS® FORAGE HARVESTERS

Replacement parts produced by Kooima® Company to fit Claas®

****When ordering processor rolls for the 491 series choppers, measure the pulley width on the rear roll. If the pulley width is 3" wide, it is a standard 491 series. If the pulley width is 4 1/4" wide, it is an updated heavy duty shaft.**

KOOIMA #
K0783751F
K0783751R



\$1,150.00 ea.

DESCRIPTION

- Kernel processor roll
- 80 tooth corn cracker special
- **New aggressive saw tooth design delivers unsurpassed performance & extended roll life in longer length crop conditions**
- **To fit 491 series Claas® harvesters 820, 840, 860 and 880 • 156 lbs.**
- **Heavy-duty 1-piece shaft included and installed!**

REPLACES OEM #

0783750
Heat Treated
156 lbs. 
F = Front
R = Rear

K0783751DCF (96 tooth)
K0783751DCR (96 tooth)

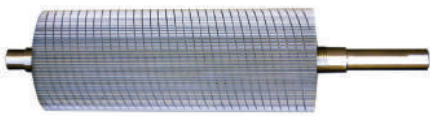

\$1,215.00 ea.

- Kernel processor roll
- **To fit 491 series Claas® harvesters 820, 840, 860 and most 880**
- **Heavy-duty 1-piece shaft included and installed!**
- Get the real value out of your processor with the new **Dual Cut High Capacity Rolls**

0783750
Heat Treated
156 lbs. 

K0678720F
K0678720R



\$1,160.00 ea.

- Kernel processor roll
- 80 tooth corn cracker special
- **To fit 492 Claas® harvesters 830, 850, 870, 890 and 900**
- **Saw tooth design**
- **Heavy-duty 1-piece shaft included and installed!**

0678720
Heat Treated
128.5 lbs. 

K0678720HPF (96 tooth)
K0678720HPR (108 tooth)

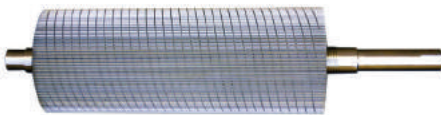

\$1,725.00 ea.

- Kernel processor roll
- Get the real value out of your processor with the new **Chevron Series Fiber Tech High Capacity Rolls**

0678720
Chromed plated roll
Heat Treated
128.5 lbs. 

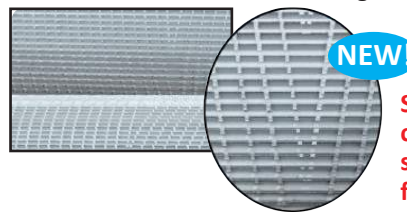

Square grooves unwrap cellulose and shred your stalk which also creates a far superior process job.

K0769392 (RH)
K0769382 (LH)



\$16.45 ea.

- Processor roll deflectors
- A real **MUST** when changing your rolls
- To fit 491 & 492 machines
- Right hand shown • .55 lbs. ea.

0769392
0769382

K0769382BK



\$4.25 ea.

- Hardware kit
- To fit K0769392 & K0769382
- **1 kit per set**
- .2 lbs.

K22208C3



\$65.80 ea.

- Kernel processor bearing
- To fit all Claas® 491, 492 & 493 series
- 2 lbs.

2382803

Truck icon signifies product is shipped via truck freight.

KOOIMA® REPLACEMENT PARTS TO FIT CLAAS® FORAGE HARVESTERS

Replacement parts produced by Kooima® Company to fit Claas®

KOOIMA #
K1400620F
K1400620R



\$1,160.00 ea.

DESCRIPTION

- Kernel processor roll
- 80 tooth corn cracker special
- **To fit 493 Speedstar® or later & 492 heavy duty**
- **To check if you have a 492 heavy duty, the rear roll shaft is 2" longer than the front roll shaft pulley side**
- **Saw tooth design • 130 lbs.**
- **Heavy-duty 1-piece shaft included and installed!**

REPLACES OEM #

1400620

Heat Treated



K1400620CF
K1400620CR



\$1,620.00 ea.

- Kernel processor roll
- 80 tooth corn cracker special
- **To fit 493 Speedstar® or later & 492 heavy duty**
- **To check if you have a 492 heavy duty, the rear roll shaft is 2" longer than the front roll shaft pulley side • 169 lbs.**
- **Heavy-duty 1-piece shaft included and installed!**

1400620

Chromed plated roll
Heat Treated



K1400620HPF (96 tooth)
K1400620HPR (108 tooth)

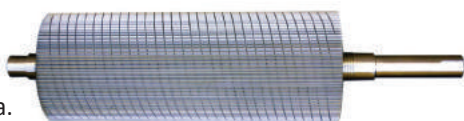

\$1,725.00 ea.

- Kernel processor roll • 130 lbs.
- Get the real value out of your processor with the new **Chevron Series Fiber Tech High Capacity Rolls**
- **Chromed plated roll**

1400620

Heat Treated

Square grooves unwrap cellulose and shred your stalk which also creates a far superior process job.



K493193



\$225.75 ea.

- Pulley • 23.25 lbs
- Recommended to have a 30% differential pulley on the 492HD and 493 processors

K494ROLLF (110 tooth)
K494ROLLR (138 tooth)

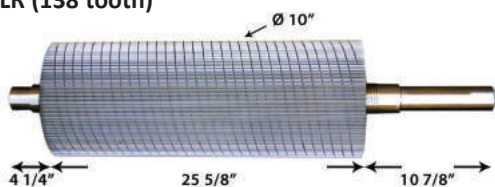

\$2,175.00 ea.

- Kernel processor roll • 215 lbs.
- Get the real value out of your processor with the new **Chevron Series Fiber Tech High Capacity Rolls**
- To fit 494 series prior to 2012
- This processor is gray in color
- **Some 494 machines may have 493 style rolls**
- **10" diameter = 494 7 5/8" diameter = 493**
- **Less down time • Less maintenance • Less repair**

Chromed plated roll
Heat Treated



K494ROLLHPF (100 tooth)
K494ROLLHPR (124 tooth)



\$2,010.00 ea.

- Kernel processor roll • 220 lbs.
- To fit 494 standard processors
- Straight saw tooth roll
- This processor is gray in color
- **Some 494 machines may have 493 style rolls**
- **10" diameter = 494 7 5/8" diameter = 493**

Chromed plated roll
Heat Treated



K494BEARING



\$120.00 ea.

- Kernel processor bearing
- To fit Claas® 494 series
- 1.4 lbs.

2172340

K494MCHPF (124 tooth)
K494MCHPR (138 tooth)

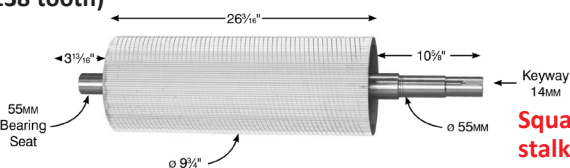

\$2,190.00

- Kernel processor roll
- To fit 494 multi crop cracker
- This processor is green in color
- **Chevron Series Fiber Tech High Capacity Rolls**

Heat Treated
Chromed plated roll

Square grooves unwrap cellulose and shred your stalk which also creates a far superior process job.



K494HPBF (Fast 124 tooth)
K494HPBR (Slow 138 tooth)

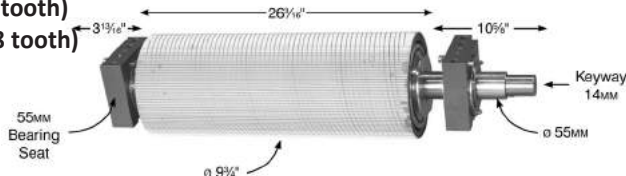

\$3,775.00 ea.

- Kernel processor roll • 288 lbs.
- To fit 494 multi crop cracker
- This processor is green in color
- Bearings included and installed
- **Chevron Series Fiber Tech for extreme processing**
- **Heat Treated / Chromed Plated**

Order online at WWW.KOOIMA.COM and receive FREE FREIGHT to your door!

KOOIMA®
COMPANY



KOOIMA® REPLACEMENT PARTS TO FIT CLAAS® FORAGE HARVESTERS

Kooima® Replacement Parts To Fit SCHERER™ Processors

K492SHF (82 tooth)
K492SHR (110 tooth)

\$2,175.00 ea.

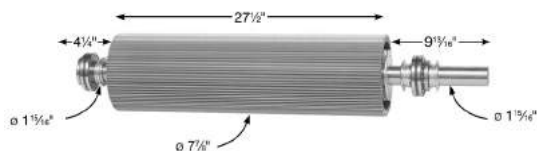

- Kernel processor roll **Heat Treated / Chromed**
- To fit Scherer™ processors made for the 491HD, 492 & 493 series Claas® harvesters
- Bearings included and installed-easy to change rolls!

K492SHPF (Fast, 90 tooth)
K492SHPR (Slow, 110 tooth)

\$2,290.00 ea.

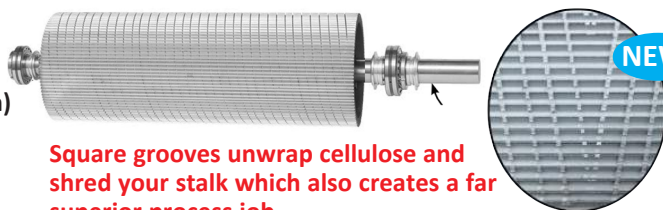

Square grooves unwrap cellulose and shred your stalk which also creates a far superior process job.

- Kernel processor roll **Heat Treated / Chromed**
- To fit Scherer™ processors made for the 491HD, 492 & 493 series Claas® harvesters
- Bearings included and installed
- **Chevron Series Fiber Tech for extreme processing performance**

K494SHF (102 tooth)
K494SHR (124 tooth)

\$2,425.00 ea.



- Kernel processor roll **Heat Treated Chromed**
- To fit Scherer™ HD processors made for the 494 series Claas® harvesters
- Bearings included and installed

K494SHHPF (Fast 124 tooth)
K494SHHPR (Slow 138 tooth)

\$2,560.00 ea.

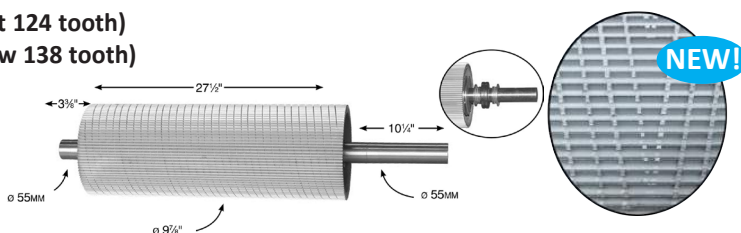

- Kernel processor roll **Heat Treated Chromed**
- To fit Scherer™ HD processors made for the 494 series Claas® harvesters
- Bearings included and installed
- **Chevron Series Fiber Tech for extreme processing performance**

Scherer™ is a trademark of Scherer Corrugating & Machine, Inc.

High Quality Silage Covers

We also carry 6 mil and 8 mil reinforced string tarps, for more information on these go to the front inside cover.



Detail of reinforced string tarps

Prices are subject to change.

Standard Silage Tarps White/Black - 5.0 mil (A5WB1)

Part #	Price	W X L	Weight
K57442	\$108.00	24 X 100	69 lbs.
K57443	\$144.00	32 X 100	90 lbs.
K57628	\$216.00	32 X 150	133 lbs.
K46534	\$180.00	40 X 100	110 lbs.
K57574	\$270.00	40 X 150	163 lbs.
K57575	\$360.00	40 X 200	216 lbs.
K50158	\$225.00	50 X 100	138 lbs.
K50159	\$337.50	50 X 150	203 lbs.
K54235	\$450.00	50 X 200	299 lbs.
K57576	\$270.00	60 X 100	161 lbs.
K53942	\$405.00	60 X 150	255 lbs.
K57577	\$540.00	60 X 200	346 lbs.
K64369	\$2,100.60	60 X 1000	1,557 lbs.
K69881	\$540.00	80 X 150	325 lbs.
K69880	\$720.00	80 X 200	455 lbs.
K70463	\$900.00	80 X 250	561 lbs.
K77059	\$2,800.80	80 X 1000	1,999 lbs.

* Free shipping on Silage Covers if combined with \$750 in Kooima® parts on phone and internet orders

KOOIMA® REPLACEMENT PARTS FOR CLAAS® DIRECT DISC MOWERS & ORBIS® 600 HEADS

Replacement parts produced by Kooima® Company to fit Claas®

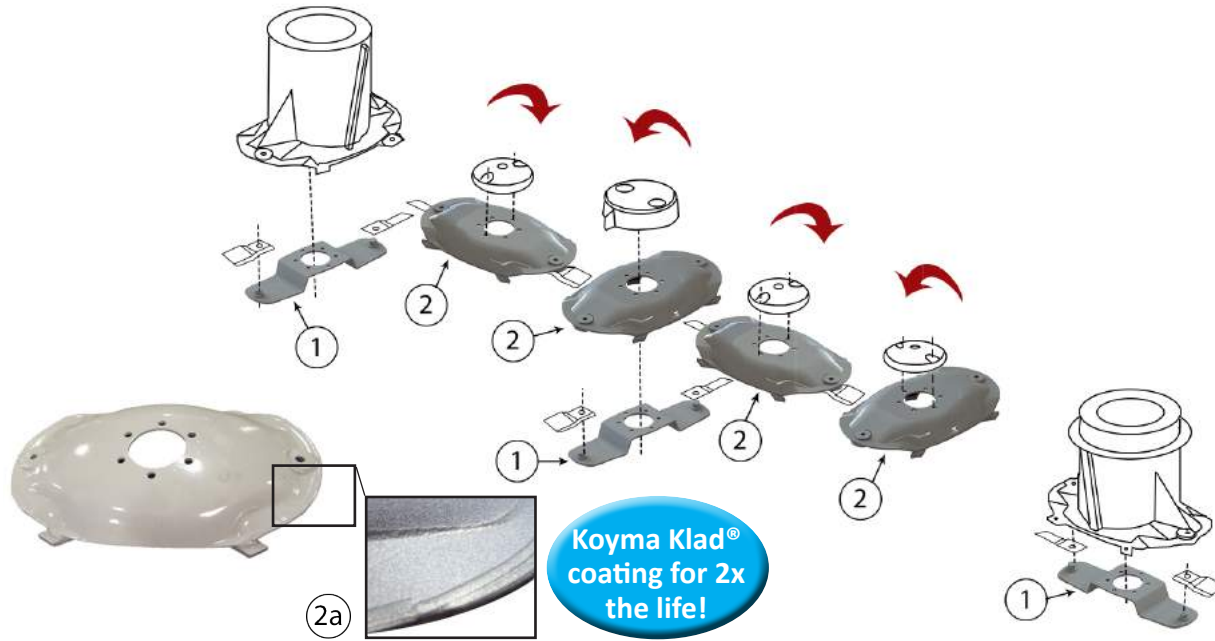

KOOIMA #	DESCRIPTION	REPLACES OEM #
K09385970	① Flat spring • 3.5 lbs. • Used to keep knives in place on direct cut mowers • Also equipped with quick change for changing out worn knives	9385970
\$70.50 ea.		
K9523400	② Turtle to fit Disco 2650 – 2700 – 3000 – 3050 – 3100 – 3450 – 8550 – 8700 and Cougar 1400 • Replacement direct cut mowing disc, 9.8" x 15.75" • 8.9lbs • Abrasive resistant coating added	9523400
\$99.45 ea.		Abrasion Resistant
K9523400HP	②a Koyma Klad® turtle to fit Disco 2650 – 2700 – 3000 – 3050 – 3100 – 3450 – 8550 – 8700 and Cougar 1400 • Replacement direct cut mowing disc, 9.8" x 15.75" • This is a Kooima® exclusive, made with Koyma Klad® coating around the edges for even longer life. Will prevent your mowing disc from cupping • 8.9 lbs. • Let Kooima's® technology help you stay in the field longer • Abrasive resistant coating added	9523400
\$125.00 ea.		Abrasion Resistant
K9389660	• Skid plate • Replacement direct cut rotary disc • 5.35 lbs.	9389660
\$29.14 ea.		Heat Treated
K13102251	DESCRIPTION • Skid plate • To fit Claas® Orbis® heads • 4 required • 23.3 lbs.	13102253 / 13102251
\$310.80 ea.		Abrasion Resistant
K4979181 (RH) K4976781 (LH)	• Intake cover • To fit Claas® Orbis® 600 heads • Right hand shown • 5.5 lbs.	4979181 4976781
\$15.30 ea.		
K4994485 (RH) \$117.50 ea. K9328845 (LH) \$141.00 ea.	• Outer crop divider snouts • To fit Claas® Orbis® heads • Left hand shown • 11.3 lbs.	23019650 23018980
K4966890 (RH) \$84.13 ea. K4965240 (LH) \$86.95 ea.	• Guide bars • To fit Claas® Orbis® 600 heads • Right hand shown • 3.1 lbs. • Made from UHMW plastic	4966890 4965240
K4965220	• RH & LH guide bar • To fit Claas® Orbis® 600 heads • 3 lbs. • Made from UHMW plastic	4965220
\$77.55 ea.		

Claas® is a registered trademark of Claas KGaA, MBH • Orbis® is a registered trademark of Claas Sauglau GmbH

Order online at WWW.KOOIMA.COM and receive FREE FREIGHT to your door!

KOOIMA®
COMPANY

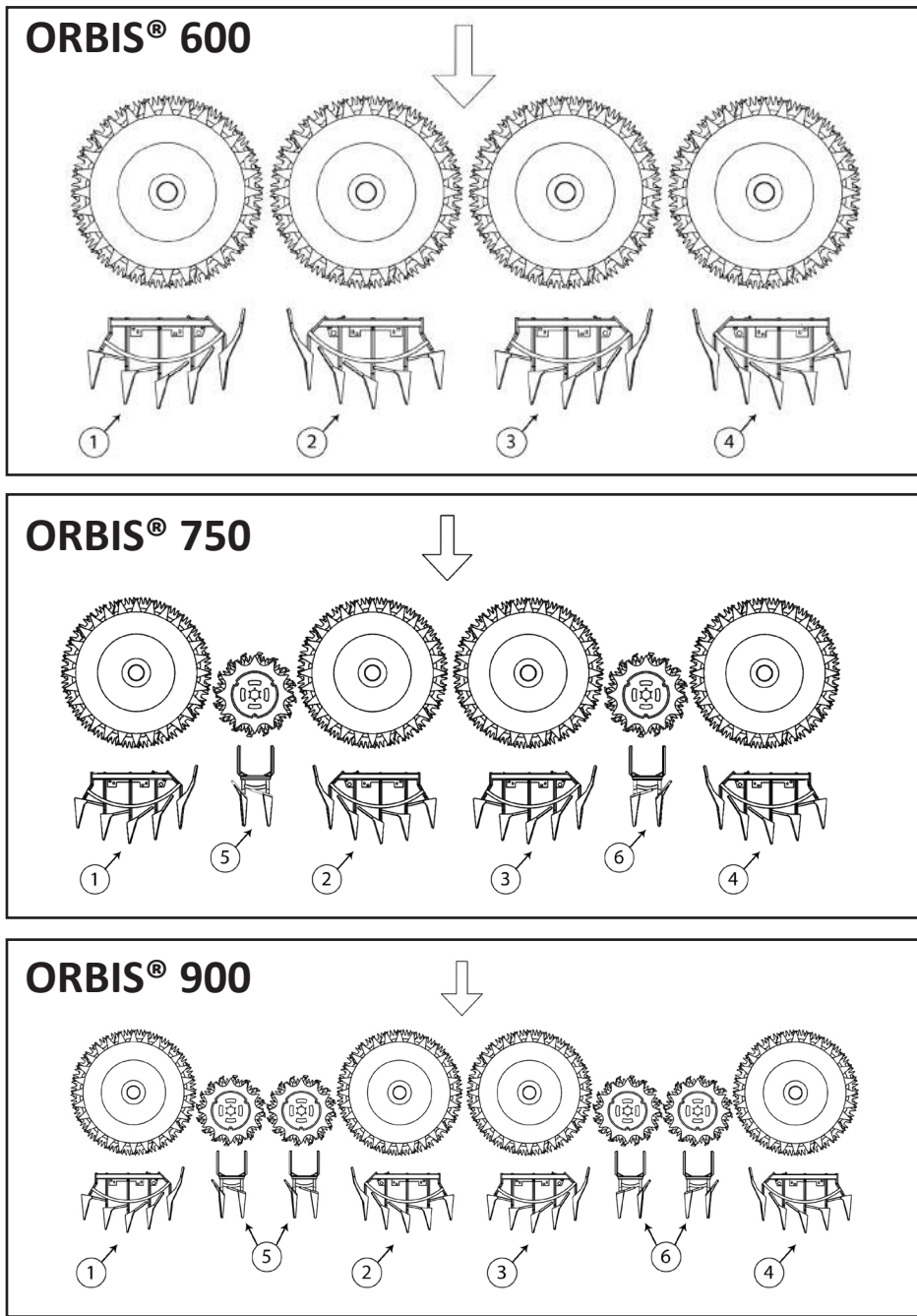

KOOIMA #	DESCRIPTION	REPLACES OEM #
K3832282 \$810.00 ea. ①	<ul style="list-style-type: none"> • Right hand outer large drum points • To fit Claas® Orbis® 600, 750 & 900 series corn heads 	3832282
K3830123 \$810.00 ea. ②	<ul style="list-style-type: none"> • Right hand inner large drum points • To fit Claas® Orbis® 600, 750 & 900 series corn heads 	3830123
K3830153 \$810.00 ea. ③	<ul style="list-style-type: none"> • Left hand inner large drum points • To fit Claas® Orbis® 600, 750 & 900 series corn heads 	3830153
K3831512 \$810.00 ea. ④	<ul style="list-style-type: none"> • Left hand outer large drum points • To fit Claas® Orbis® 600, 750 & 900 series corn heads 	3831512
K3830231 \$410.00 ea. ⑤	<ul style="list-style-type: none"> • Right hand small drum points • To fit Claas® Orbis® 600, 750 & 900 series corn heads 	26081900 / 3830231
K3830221 \$410.00 ea. ⑥	<ul style="list-style-type: none"> • Left hand small drum points • To fit Claas® Orbis® 600, 750 & 900 series corn heads 	26080900 / 3830221

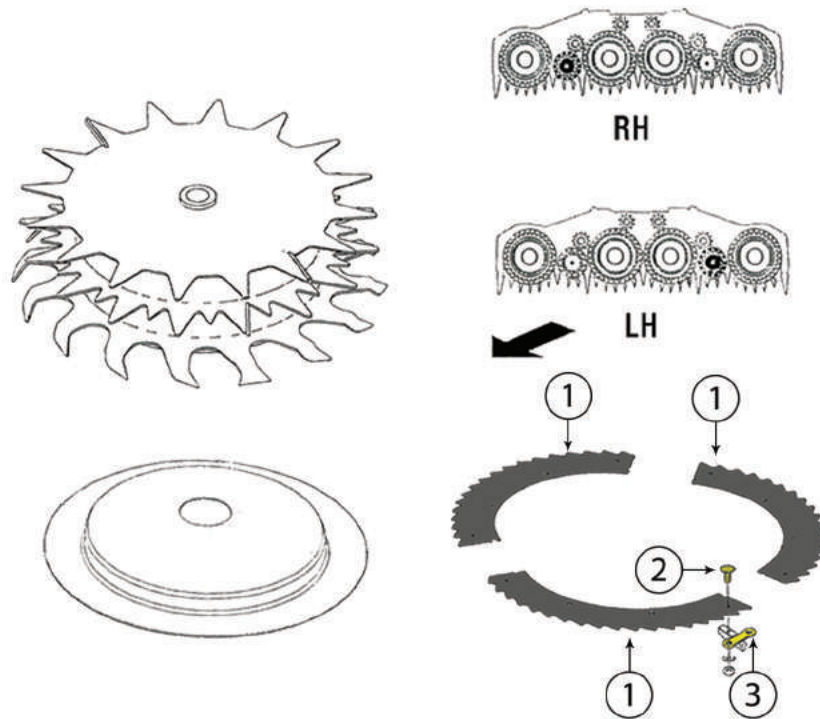

KOOIMA #
K4997071

\$51.70 ea.

K4988781

\$51.70 ea.

ORBIS750BK

\$25.30 ea.

K13195720

\$21.15 ea.

K13195720HP

\$32.85 ea.

DESCRIPTION

- ① • Knife LH
 - To fit Claas® Orbis® 750 & 900 heads
 - 3 required • 3.6 lbs.
- ① • Knife RH
 - To fit Claas® Orbis® 750 & 900 heads
 - 3 required • 3.6 lbs.
- ② • Bolt Kit
 - To fit Claas® Orbis® 750 small drum knives
 - 2 bolt kits needed for Claas® Orbis® 900 • 2.75 lbs.
- ③ • Scraper
 - To fit Claas® Orbis® 750 & 900 heads
 - 3 required per drum • .7 lbs.
- ③ • **Koyma Klad® coating for extended life** • To fit Claas® Orbis® 750 & 900 heads
 - 3 required per drum • .7 lbs.

REPLACES OEM #
23008361 / 4997073

Abrasion Resistant

23008341 / 4988783

Abrasion Resistant

13109570 / 13195720

Abrasion Resistant

13109570 / 13195720

Abrasion Resistant

Tungsten Hard-Faced

SILAGE TESTER

- Tests freshly chopped and ensiled silage.
- Tester stays clean; plastic bags prevent contamination of test cell.
- Tests in one minute.
- Digital log reading with conversion chart for common silage types.
- Accurate within 2% (average) for silage under 50% moisture.
- Accurate within 3% (average) for silage over 50% moisture.
- Accurate within 1% for grain at normal stored moisture.
- Testing range: 30% - 75% (silage), 10% - 47% (grain).
- Full one year warranty. • 4 lbs.

Silage Tester
Order # K1210
Only
\$325⁸⁰ea.

Replacement Bags
100 Count
Order # K06801
\$25³⁰ea.



KOOIMA® REPLACEMENT PARTS FOR CLAAS® ORBIS® 600, 750 & 900 HEADS

Replacement parts produced by Kooima® Company to fit Claas®

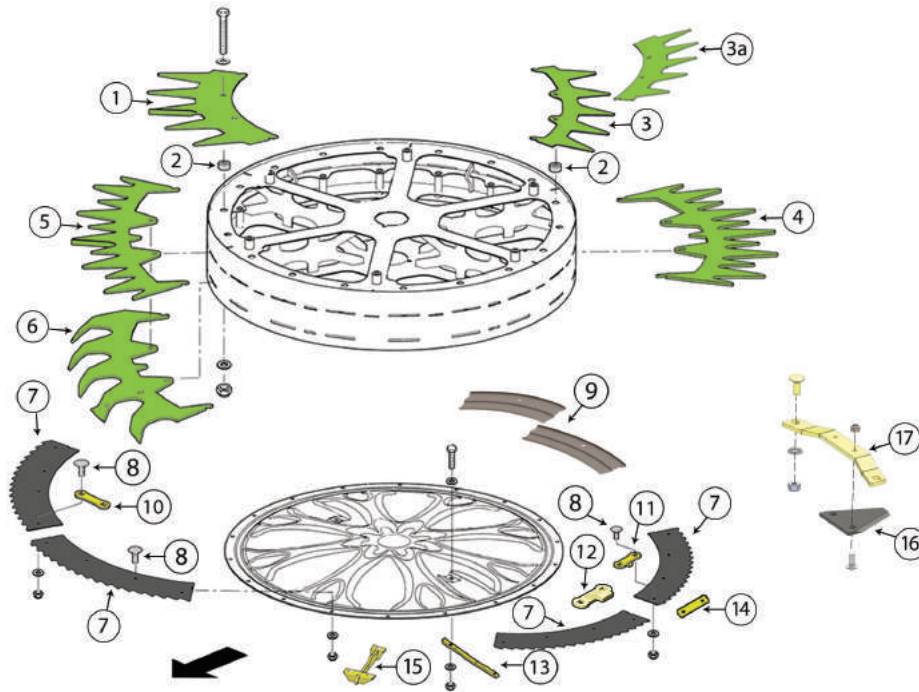

KOOIMA #	DESCRIPTION	REPLACES OEM #
K4986171 \$28.20 ea.	① Segment • 2 required • To fit Claas® Orbis® 600, 750 & 900 large drums • 5.8 lbs. • From serial no. 658 0 1334	4986172 / 4986171 Abrasion Resistant
K4979540 \$2.45 ea.	② Bushing • 18 required • To fit Claas® Orbis® 600 & 900 heads • .35 lbs. • From serial no. 658 0 1334	4979540
K13108071 \$25.30 ea.	③ Segment • 4 required • To fit Claas® Orbis® 600, 750 & 900 large drums • 4.5 lbs. • From serial no. 658 0 1334	13108071 Abrasion Resistant
K13108070 \$20.30 ea.	③a Segment • 4 required • To fit Claas® Orbis® 600 heads • 5.6 lbs. • Up to serial no. 658 0 1333	13108070 Abrasion Resistant
K13108080 \$21.62 ea.	④ Segment • 4 required • To fit Claas® Orbis® 600, 750 & 900 large drums • 4.5 lbs. • From serial no. 658 0 1334	13108080 Abrasion Resistant
K4986161 \$28.20 ea.	⑤ Segment • 2 required • To fit Claas® Orbis® 600, 750 & 900 large drums • 4.6 lbs. • From serial no. 658 0 1334	4986161 Abrasion Resistant
K4970251 \$36.19 ea.	⑥ Segment • 6 required • From serial no. 658 0 1334 • To fit Claas® Orbis® 600, 750 & 900 large drums • 7.55 lbs.	4970251 Abrasion Resistant
K4999651 \$36.19 ea.	⑥ Segment • 6 required • From serial no. 658 0 1334 • To fit Claas® Orbis® 600, 750 & 900 large drums • 7.55 lbs.	4999651 Abrasion Resistant
K13101080 \$63.50 ea.	⑦ Knife • From serial no. 658 0 1334 • To fit Claas® Orbis® 600, 750 & 900 large drums • 6 required • 4.6 lbs.	13101082 Abrasion Resistant
K13116270 \$63.50 ea.	⑦ Knife • From serial no. 658 0 1334 • To fit Claas® Orbis® 600, 750 & 900 large drums • 6 required • 4.6 lbs.	13116272 Abrasion Resistant
ORBIS600BK \$95.00 ea.	⑧ Bolt Kit • 9.5 lbs. • To fit Claas® Orbis® 600, 750 and 900 knives • 1 kit required • From serial no. 658 0 1334 • Also need 1 ORBIS750BK • Need 2 ORBIS750BK for 900 knives (See page 151)	
K4990060 \$19.27 ea.	⑨ Reinforcement Plate • 9 required per rotor • To fit Claas® Orbis® 600, 750 and 900 Heads • 1.15 lbs.	4990060
K13103490 \$3.06 ea.	⑩ Strip • 4 required • To fit Claas® Orbis® 600, 750 and 900 heads • .15 lbs. • From serial no. 658 0 1334	13103490 Abrasion Resistant
K13102981 \$19.80 ea.	⑪ Scraper • 2 required • .3 lbs. • To fit Claas® Orbis® 600, 750 and 900 heads • From serial no. 658 0 1334	3831480/13102981 Abrasion Resistant
K3831480 \$19.80 ea.	⑫ Scraper • From serial no. 659 0 1673 • Koyma Klad® coating for extended life • .3 lbs.	3831480 Abrasion Resistant/Tungsten Hard-Faced
K1310932 \$39.50 ea.	⑬ Scraper • 2 required • To fit Claas® Orbis® 600, 750 and 900 heads • .85 lbs. • From serial no. 658 0 1334	13100934 Abrasion Resistant
K3831470 \$18.80 ea.	⑬a Scraper • 2 required • To fit Claas® Orbis® 750 and 900 heads • .91 lbs. • From serial no. 659 0 1673	3831470 Abrasion Resistant
K9968071 \$2.12 ea.	⑭ Reinforcement • 6 required • To fit Claas® Orbis® 600 heads • .05 lbs. • Up to serial no. 658 0 1333	9968071 Abrasion Resistant
K4992202 \$14.75 ea.	⑮ Scraper • .9 lbs. • To fit Claas® Orbis® 600 heads • Up to serial no. 658 0 1333	4992202 Abrasion Resistant

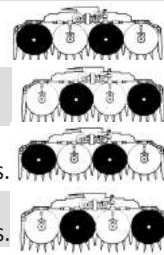

KOOIMA® REPLACEMENT PARTS FOR CLAAS® ORBIS® 750 & 900 HEADS

Replacement parts produced by Kooima® Company to fit Claas®

KOOIMA #	DESCRIPTION	REPLACES OEM #
K6112031 \$1.40 ea.	• Knife section • 2 required per drum • .20 lbs. • To fit Claas® Orbis® 600, 750 & 900 large drums • Bolt kit: K6112031BK - 1 kit per knife req'd, \$2.15 ea.	6112031
K3832211 \$18.80 ea.	• Knife section support • 1 required per knife • To fit Claas® Orbis® 600, 750 & 900 heads • Bolt kit: K3832211BK - 1 kit per support req'd \$4.00 ea.	3832211 Heat Treated
HEAD KITS		
KORBIS600 \$1,619.00 ea.	• Head Kit - Includes knives and bolt kits: (12) K13101080, (12) K13116270, (1) ORBIS600BK • To fit Claas® Orbis® 600 head	
KORBIS750 \$1,954.50 ea.	• Head Kit - Includes knives and bolt kits: (12) K13101080, (12) K13116270, (1) ORBIS600BK • To fit Claas® Orbis® 750 head (3) K4997071, (3) K4988781, (1) ORBIS750BK	
KORBIS900 \$2,290.00 ea.	• Head Kit - Includes knives and bolt kits: (12) K13101080, (12) K13116270, (1) ORBIS600BK • To fit Claas® Orbis® 900 head (6) K4997071, (6) K4988781, (2) ORBIS750BK	

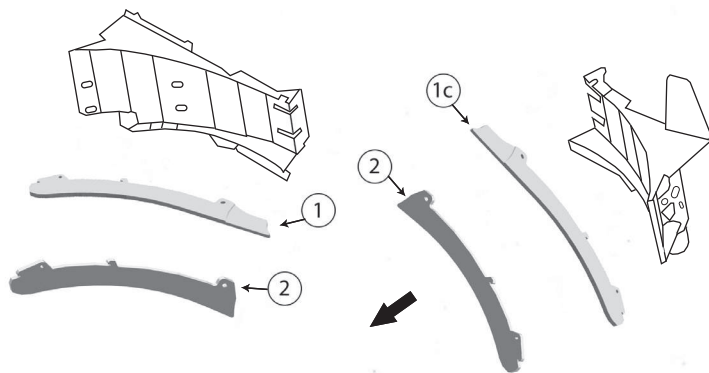

**More Options With
Kooima® AR Steel Guide Bars**

KOOIMA #	DESCRIPTION	REPLACES OEM #
K04972881 (left side) \$65.45 ea.	① • Inside replacement guide bar top • 4 lbs. • To fit Claas® Orbis® 900 heads • Also fits 750 SN. 65901068 & after • Made from UHMW plastic • Left side shown	4972881
K13194810 \$126.00 ea.	①b • Inside replacement guide bar top • To fit Claas® Orbis® 900 heads • 22.6 lbs. • Also fits 750 SN. 65901068 & after • Made from High Abrasion Resistant Steel • Turn your Orbis® head into a cutting machine all year long • Left	13194810 Abrasion Resistant
K04971101 (right side) \$66.00 ea.	①c • Inside replacement guide bar top • To fit Claas® Orbis® 900 heads • Also fits 750 SN. 65901068 & after • Made from UHMW plastic • 2.8 lbs.	4971101
K13194800 \$126.00 ea.	①d • Inside replacement guide bar top • To fit Claas® Orbis® 900 heads • Also fits 750 SN. 65901068 & after • Made from High Abrasion Resistant Steel • Turn your Orbis® head into a cutting machine all year long • 22.3 lbs. • Right	13194800 Abrasion Resistant
K04967642 \$62.00 ea.	② • Inside replacement guide bar bottom • To fit Claas® Orbis® 900 heads • Also fits 750 SN. 65901068 & after • Made from UHMW plastic • 2 required per head • 2.5 lbs.	4967642
K13194790 \$126.00 ea.	②a • Inside replacement guide bar bottom • To fit Claas® Orbis® 900 heads • Also fits 750 SN. 65901068 & after • Made from High Abrasion Resistant Steel • Turn your Orbis® head into a cutting machine all year long with extended life steel guide bars • 19.8 lbs.	13194790 Abrasion Resistant

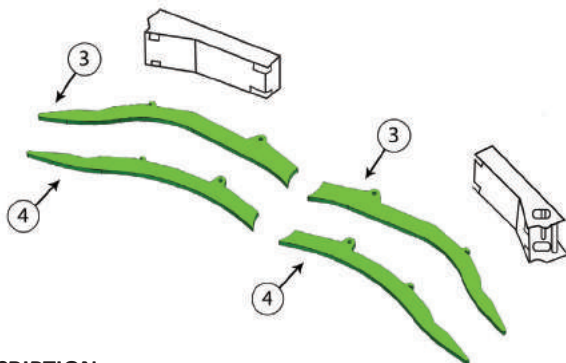

KOOIMA #	DESCRIPTION	REPLACES OEM #
K13102630 \$53.00 ea.	③ • Small drum guide bars • To fit Claas® Orbis® 900 heads • Made from UHMW plastic • 4 required • 2.4 lbs.	13102630
K13196970 \$126.00 ea.	③a • Small drum guide bars • To fit Claas® Orbis® 900 heads • Made from High Abrasion Resistant Steel • Turn your Orbis® head into a cutting machine all year long • 19.8 lbs.	13196970 Abrasion Resistant
K4968222 \$74.00 ea.	④ • Small drum guide bar • To fit Claas® Orbis® 750 heads • 4 required • UHMW high wear plastic • 2 lbs.	4968222

Order online at WWW.KOOIMA.COM and receive FREE FREIGHT to your door!



KOOIMA® REPLACEMENT PARTS FOR CLAAS® ORBIS® 750 & 900 HEADS

Replacement parts produced by Kooima® Company to fit Claas®

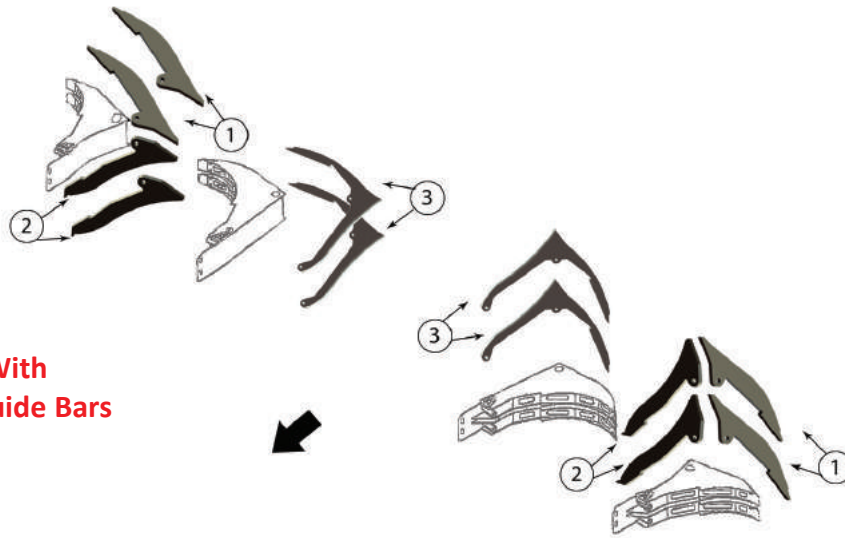

**More Options With
Kooima® AR Steel Guide Bars**

KOOIMA #	DESCRIPTION	REPLACES OEM #
K04994640	<ul style="list-style-type: none"> • Outside small drum guide bar • To fit Claas® Orbis® 900 heads • Made from UHMW plastic • 4 required per head • .65 lbs. 	4994640
\$36.00 ea.	①	
K04994640HP	<ul style="list-style-type: none"> • Outside small drum guide bar • 5.3 lbs. • To fit Claas® Orbis® 900 heads • Made from high abrasion resistant steel • Turn your Orbis® head into a cutting machine all year long • 4 required per head 	4994640 Abrasion Resistant
\$81.00 ea.	①a	
K13102890	<ul style="list-style-type: none"> • Inside small drum guide bar • To fit Claas® Orbis® 900 heads • Made from UHMW plastic • 4 required per head • .65 lbs. 	13102890
\$36.00 ea.	②	
K13102890HP	<ul style="list-style-type: none"> • Inside small drum guide bar • 5.65 lbs. • To fit Claas® Orbis® 900 heads • Made from high abrasion resistant steel • Turn your Orbis® head into a cutting machine all year long • 4 required per head 	13102890 Abrasion Resistant
\$81.00 ea.	②a	
K04969022	<ul style="list-style-type: none"> • Stripper guide bar • To fit Claas® Orbis® 900 heads and 750 after SN# 65901068 • Made from UHMW plastic • 4 required per head • 1.45 lbs. 	4969022
\$59.00 ea.	③	
K04969022HP	<ul style="list-style-type: none"> • Stripper guide bar • To fit Claas® Orbis® 900 heads and 750 after SN# 65901068 • Made from high abrasion resistant steel • 12.2 lbs. • Turn your Orbis® head into a cutting machine all year long • 4 required per head 	4969022 Abrasion Resistant
\$111.00 ea.	③a	

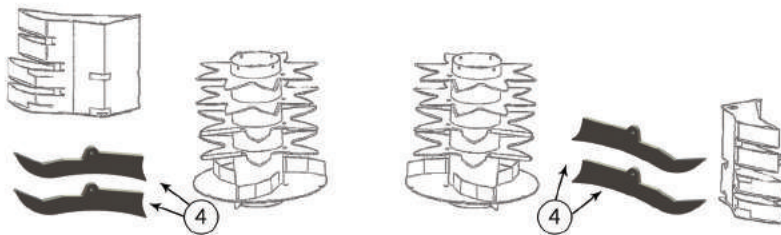

KOOIMA #	DESCRIPTION	REPLACES OEM #
K13103320	<ul style="list-style-type: none"> • Guide bar for outside rail • To fit Claas® Orbis® 900 heads • Made from UHMW plastic • 4 required per head • 1.1 lbs. 	13103320
\$39.00 ea.	④	
K13103320HP	<ul style="list-style-type: none"> • Guide bar for outside rail • 9.35 lbs. • To fit Claas® Orbis® 900 heads • Made from high abrasion resistant steel • Turn your Orbis® head into a cutting machine all year long • 4 required per head 	13103320 Abrasion Resistant
\$86.00 ea.	④a	

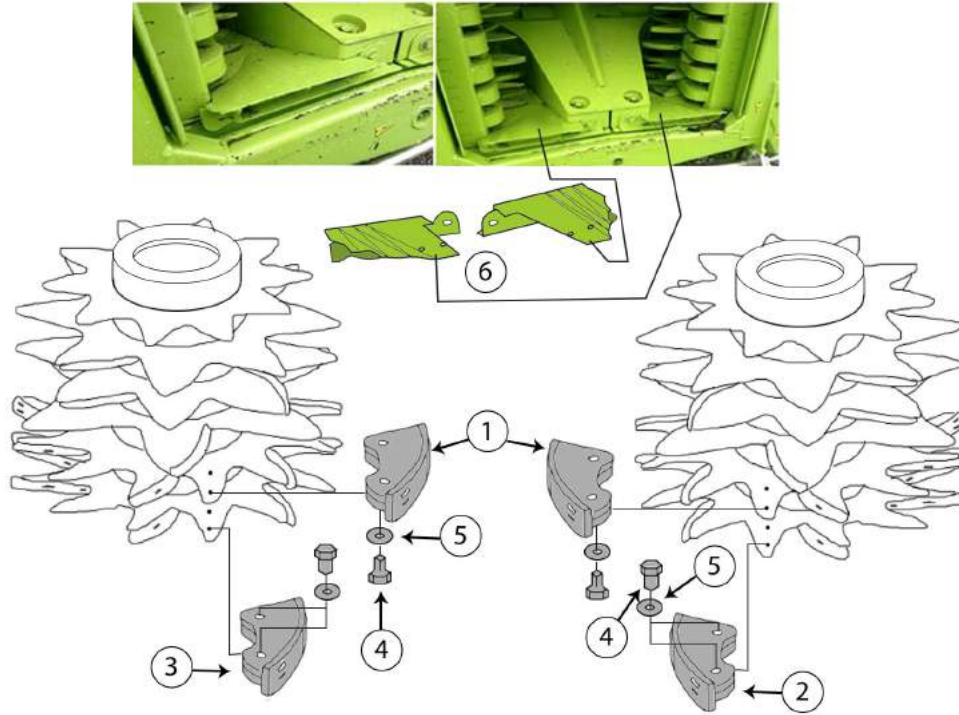

KOOIMA #	DESCRIPTION	REPLACES OEM #
K13109450 \$20.50 ea.	① Intake drum scraper • To fit Orbis® 450-900 series • 6 required	13109450
K13109550 \$24.00 ea.	② Left hand drum scraper • To fit Orbis® 450-900 series • 3 required	13109550
K13109570 \$24.00 ea.	③ Right hand drum scraper • To fit Orbis® 450-900 series • 3 required	13109570
K54530816 \$0.80 ea.	④ Drum scraper bolt • Use with K13109450, K13109550 & K13109570 scrapers • 2 required per scraper • .035 lbs.	2333900
K54532008 \$0.80 ea.	⑤ Drum scraper washer • Use with K13109450, K13109550 & K13109570 scrapers • 2 required per scraper • .005 lbs.	2393870
K23003690 \$367.00 ea.	⑥ Crop flow kit • Increase capacity with better crop flow to cutter head • To fit Orbis® 450-900 series	23003690

The Rock Stop'er Pro

FORAGE HARVESTER STONE DETECTION SYSTEM



JD® must have double spring kit installed.

- Fits most makes and models of SPFH and pull type harvesters.
- Patented Inertia sensor stops feed drive when rocks are detected.
- In cab sensitivity adjustment for varying crop conditions.
- Call 1-800-522-8874 for more details!



Extra Sensor Available!
Order # SENSOR
Only \$750⁸⁰ ea.

Order # ROCK STOPER
Only \$2,950⁰⁰ ea.



Designed and manufactured in Canada.

Order online at WWW.KOOIMA.COM and receive FREE FREIGHT to your door!



Your #1 Source For Used Parts



Claas® Self-Propelled Forage Harvester **PARTS**



1-877-427-6950

www.iowacuttersupply.com

Claas®

John Deere®

Kemper™

New Holland®

Krone®

Iowa Cutter Supply
1 1/2 miles East on Hwy 18
2642 Rock Ridge Road
Rock Valley, IA 51247

If you have a cutter to sell:
Email pictures and a description to
sales@iowacuttersupply.com
or
Call 1-877-427-6950 and ask for Ivan

HEAD CART



Easily moves 678 Kemper™



Pull it with your chopper or pickup



Easily moves 15' hay heads

This SPFH friendly head cart will keep your expensive chopping and hay heads off the ground, while you enjoy the benefits of easy loading and unloading using your existing chopper. The 9000 lb. rated capacity and 15' base accommodate a large range of heads.

US Patent: 8,919,800

Order # KHC15

Call For Pricing

Optional Hitch Pin /
Clevis Connection

Order # FH5001013

\$100⁷⁵ ea. 8.35 lbs.



CROP DIVIDER ASSEMBLIES

Kemper™ style Crop Dividers to fit Claas® RU 600 and New Holland® RI 600 series corn heads

The RU and RI heads are great, but have a tendency to double cut the stalk, leaving a trail of 6-8 inch long chunks lying in the field. This new Crop Divider holds the stalk up and in tighter to the drum for a single clean cut with no waste. Your customers will notice the difference and so will you! We ran them on our RU head and loved them. Call today for more details.

Order # K600PAKIT
(to fit RU 600 & RI 600 8-row)
• Uses 2 RH, 2 LH assemblies

\$2,550⁰⁰ ea.

276 lbs.



Order # K450PAKIT
(to fit RU 450 6-row)
• Uses 2 RH, 1 LH assemblies

\$2,050⁰⁰ ea.

180 lbs.



Order # K9906070

- Crop dividers use the K9906070 skid plates • 14 lbs.
- 3 required for the RU450
- 4 required for the RU600
- Replaces OEM # 9906070

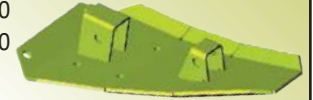

\$105⁰⁰ ea.

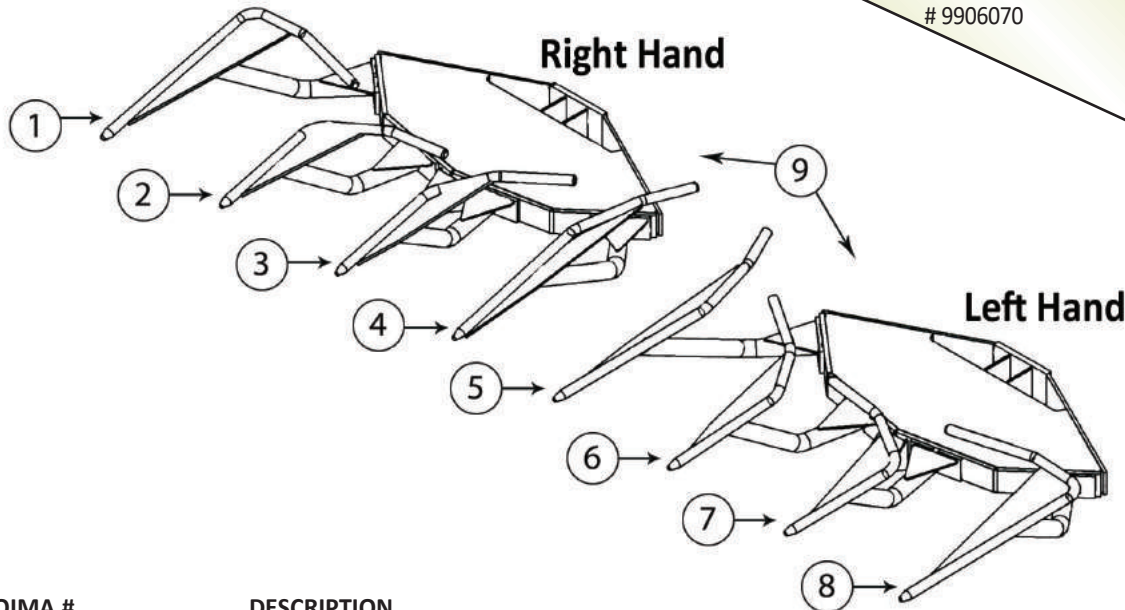

KOOIMA #	DESCRIPTION	REPLACES OEM #
K9995851 \$112.00 ea.	① • RH Point • To fit Claas® RU corn heads • 8.3 lbs.	9995851
K9995901 \$112.00 ea.	② • RH Point • To fit Claas® RU corn heads • 6.4 lbs.	9995901
K9995941 \$112.00 ea.	③ • RH Point • To fit Claas® RU corn heads • 6.6 lbs.	9995941
K9995992 \$112.00 ea.	④ • RH Point • To fit Claas® RU corn heads • 7.2 lbs.	9995992
K9996012 \$112.00 ea.	⑤ • LH Point • To fit Claas® RU corn heads • 6.9 lbs.	9996012
K9996031 \$112.00 ea.	⑥ • LH Point • To fit Claas® RU corn heads • 6.6 lbs.	9996031
K9996051 \$112.00 ea.	⑦ • LH Point • To fit Claas® RU corn heads • 6.5 lbs.	9996051
K9996071 \$112.00 ea.	⑧ • LH Point • To fit Claas® RU corn heads • 8.1 lbs.	9996071
K600PA \$355.00 ea.	⑨ • Base • To fit Claas® RU corn heads • 41.4 lbs.	











Claas® is a registered trademark of Claas KGaA, MBH • New Holland® is a registered trademark of CNH Industrial America, LLC • Kemper™ is a trademark of Maschinenfabrik KEMPER GmbH & Co. Truck icon signifies product is shipped via truck freight.

TO ORDER CALL TOLL FREE 1-800-522-8874

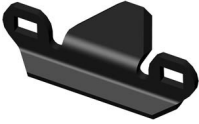

KOOIMA® REPLACEMENT PARTS TO REPLACE CLAAS® RU 450 & 600 SERIES ROTARY HEADS

Replacement parts produced by Kooima® Company to fit Claas®

KOOIMA #	DESCRIPTION	REPLACES OEM #
K9963130 	<ul style="list-style-type: none"> Flat cutting blade To fit right hand & center drums on RU 450 & RU 450XTRA 6-row heads 10 required on RU 450 & RU 450XTRA heads • 1.7 lbs. 	9963130 Heat Treated Tungsten Carbide
\$31.50 ea.		
K9995490 	<ul style="list-style-type: none"> Flat cutting blade To fit right hand & center drums on RU 450 & RU 450XTRA 6-row heads 10 required • 1.7 lbs. 	9995490 Heat Treated Tungsten Carbide
\$31.50 ea.		
K9963100 	<ul style="list-style-type: none"> Flat cutting blade To fit left hand drums on RU 450 & RU 450XTRA 6-row heads 5 required on RU 450 & RU 450XTRA heads • 1.7 lbs. 	9963100 Heat Treated Tungsten Carbide
\$31.50 ea.		
K9995540 	<ul style="list-style-type: none"> Flat cutting blade To fit left hand drums on RU 450 & RU 450XTRA 6-row heads 5 required • 1.7 lbs. 	9995540 Heat Treated Tungsten Carbide
\$31.50 ea.		
KRU450BK 	<ul style="list-style-type: none"> Metric bolt kit To fit RU 450 6-row heads 1 kit required per head 10.25 lbs. 	
\$80.45 ea.		
KRU600BK 	<ul style="list-style-type: none"> Metric bolt kit To fit RU 600 8-row heads 1 kit required per head 13.5 lbs. 	
\$105.00 ea.		
K9919821 	<ul style="list-style-type: none"> Blade scraper To fit RU 450XTRA heads & RU 450 IF using XTRA style blades To fit RU 600 8-row heads 15 required for 450; 20 required for 600 • .15 lbs. 	9919822 Heat Treated Tungsten Carbide
\$11.75 ea.		
K9961221 	<ul style="list-style-type: none"> Drum scraper To fit Claas® RU 450 and RU 450XTRA heads To fit Claas® RU 600 and New Holland® RI 600 heads 2 required per drum • .6 lbs. 	9961221 Abrasion Resistant
\$6.50 ea.		
K9968071 	<ul style="list-style-type: none"> Reinforcement To fit Claas® RU 450 and RU 450XTRA heads To fit Claas® RU 600 and RU 600XTRA heads 5 required per rotor • .05 lbs. 	9968071 Abrasion Resistant
\$2.12 ea.		
K9998170 	<ul style="list-style-type: none"> Flat cutting blade To fit right hand and center drums on RU 600XTRA 8-row heads 20 required 2.5 lbs. 	9998170 Heat Treated Tungsten Carbide
\$42.75 ea.		
K9998160 	<ul style="list-style-type: none"> Flat cutting blade To fit left hand and center drums on RU 600XTRA 8-row heads 20 required 2.5 lbs. 	9998160 Heat Treated Tungsten Carbide
\$42.75 ea.		

KOOIMA® REPLACEMENT PARTS FOR CLAAS® RU 600XTRA HEADS

Replacement parts produced by Kooima® Company to fit Claas®

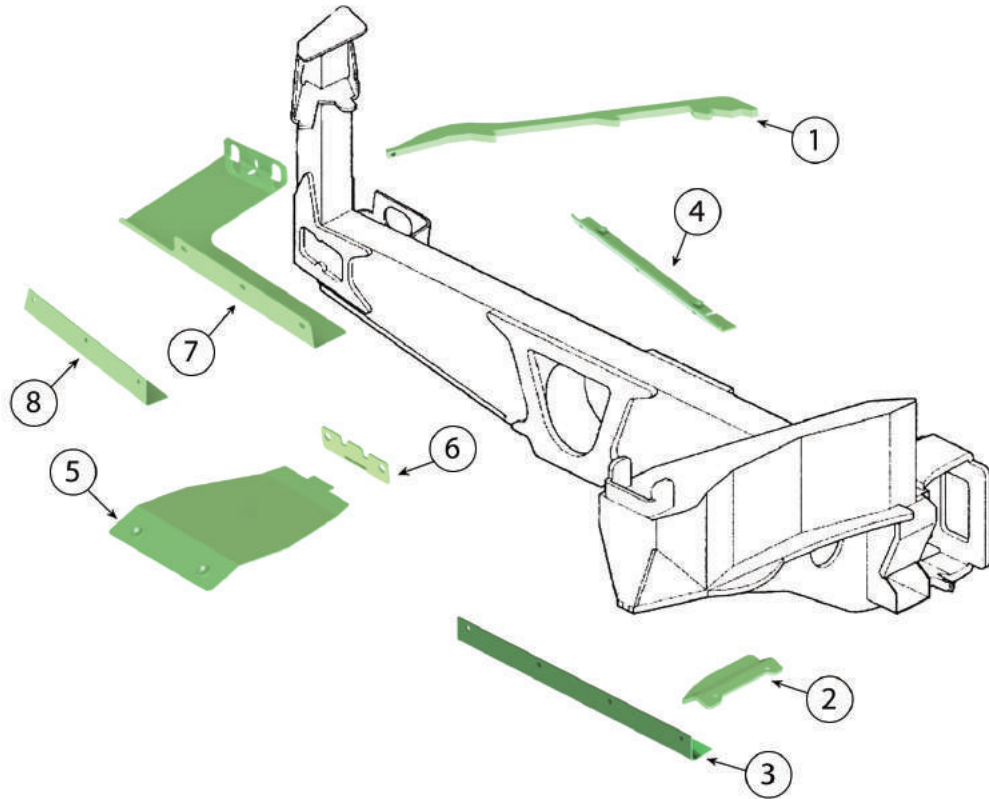











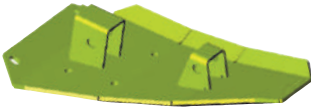

KOOIMA #	DESCRIPTION	REPLACES OEM #
K9908390	① Wing guide bar • To fit Claas® RU 600 & New Holland® RI 600 8-row heads • 2 required • 5.1 lbs.	9908390
\$38.00 ea.		Abrasion Resistant
K9911470 (LH)	② Feed guide plate • To fit Claas® RU 600 and New Holland® RI 600 8-row heads • 1 each required • 1.8 lbs. ea.	9911471
K9921810 (RH)		9921811
\$30.08 ea.		Abrasion Resistant
K9924421	③ Frame wear angle • To fit Claas® RU 600XTRA 8-row heads • 2 required • 2.8 lbs.	13117550 / 9924421
\$17.80 ea.		
K9924440 (RH)	④ Support angle • To fit Claas® RU 600XTRA 8-row heads • 1 each required • 1.7 lbs. ea.	9924440
K9901390 (LH)		9901390
\$21.90 ea.		
K9977970	⑤ Skid plate cover • To fit Claas® RU 600XTRA 8-row heads • 1 required • 5.2 lbs.	9977970
\$39.35 ea.		
K2360560	⑤a Hexagonal screw • To fit K9977970 • .1 lbs.	2360560
\$0.75 ea.		
K9977950	⑥ Skid rail • To fit Claas® RU 600XTRA 8-row heads • 1 required • 5.2 lbs.	9977950
\$7.25 ea.		
K2335070	⑥a Hexagonal screw • To fit K9977950 • .4 lbs.	2335070
\$6.50 ea.		
K2393910	⑥b Contact washer • To fit K9977950 • .1 lbs.	2393910
\$1.05 ea.		
K4976450 (LH)	⑦ Wear plate • To fit Claas® RU 600XTRA heads • 1 each required • Serial #66102457 and above • 4.4 lbs. ea.	4976450
K4976440 (RH)		4976440
\$29.80 ea.		
K9924432	⑧ Wear plate • To fit Claas® RU 600XTRA heads • 1 required • Serial #66102456 and below • 1.8 lbs.	9924432
\$12.25 ea.		

Order online at WWW.KOOIMA.COM and receive FREE FREIGHT to your door!















KOOIMA® REPLACEMENT PARTS FOR CLAAS® RU 600 HEADS

Replacement parts produced by Kooima® Company to fit Claas®

KOOIMA #		DESCRIPTION	REPLACES OEM #
K9906070		<ul style="list-style-type: none"> • Skid plate • To fit Claas® RU 600 8-row heads • 4 required • 14 lbs. 	9906070 Abrasion Resistant
\$105.00 ea.			
K9910080		<ul style="list-style-type: none"> • Crop divider snoot • To fit Claas® RU 600 8-row heads • 4 required • 5.3 lbs. 	9910081
\$135.75 ea.			
K9906460		<ul style="list-style-type: none"> • Crop divider snoot • To fit Claas® RU 600 8-row heads • 2 required • 11.4 lbs. 	9906461
\$153.75 ea.			
K9915641		<ul style="list-style-type: none"> • Deflector plate • To fit crop divider #K9906460 • 7.1 lbs. 	9915642 Abrasion Resistant
\$120.75 ea.			
K9920460 (Left) K9903340 (Right)		<ul style="list-style-type: none"> • Crop guide plate • To fit Claas® RU 600 8-row heads • 1 each required • 7.8 lbs. ea. 	13117440 / 9920460 13117430 / 9903340 Abrasion Resistant
\$59.35 ea.			
K9967101		<ul style="list-style-type: none"> • Feed cone tooth • To fit Claas® RU 600 and New Holland® RI 600 series 8-row heads • 16 required • .6 lbs. 	9967101 Abrasion Resistant
\$8.75 ea.			
K9966430 (103mm)		<ul style="list-style-type: none"> • Auger tooth • To fit Claas® RU 600 & New Holland® RI 600 series 8-row heads • 4 required • 3.1 lbs. 	9966431 Abrasion Resistant
\$19.30 ea.			
K9922772 (Left) K9922842 (Right)		<ul style="list-style-type: none"> • Outer crop divider snoot • To fit Claas® RU 600, RU 450 and New Holland® RI 600, RI 450 series 6 & 8-row heads • 1 each required • 8.8 lbs. ea. 	9922776 9922846
\$150.75 ea.			
K9322660		<ul style="list-style-type: none"> • Center crop divider snoot • To fit Claas® RU 600 and New Holland® RI 600 series 8-row heads • 1 each required • 17 lbs. 	9322660
\$153.75 ea.			
K9917810 (RH) K9917800 (LH)		<ul style="list-style-type: none"> • Feed guide • To fit Claas® RU 600Xtra heads • 2 required • 2.8 lbs. ea. 	9917810 9917800 Abrasion Resistant
\$45.35 ea.			
K9966370		<ul style="list-style-type: none"> • Cutoff knife, end drum • To fit Claas® RU 600 8-row heads • 2 required per head • .6 lbs. 	9966370 Abrasion Resistant Tungsten Carbide
\$19.30 ea.			
K9908400		<ul style="list-style-type: none"> • Center guide bar • To fit Claas® RU 600 & New Holland® RI 600 8-row heads • 2 required • 9.4 lbs. 	9908401 Abrasion Resistant
\$65.45 ea.			

KOOIMA® REPLACEMENT PARTS FOR CLAAS® RU 600 HEADS

Replacement parts produced by Kooima® Company to fit Claas®











KOOIMA #		DESCRIPTION	REPLACES OEM #
K9910000		<ul style="list-style-type: none"> • Outside guide bar • To fit Claas® RU 600 & New Holland® RI 600 8-row heads • 2 required • 2.1 lbs. 	9910001 / 9910000 Abrasion Resistant
\$33.85 ea.			
K9916622 (Left) K9916692 (Right)		<ul style="list-style-type: none"> • Rotor cover • To fit Claas® RU 600 8-row heads • 1 required • Left hand shown • 35 lbs. ea. 	9916622 9916692 Abrasion Resistant
\$390.80 ea.			
K9908910 (Left) K9908870 (Right)		<ul style="list-style-type: none"> • Crop guide plate for the rotor covers listed above • 1 each required • .3 lbs. 	9908910 9908870 Abrasion Resistant
\$29.30 ea.			
K9908910BK		<ul style="list-style-type: none"> • Bolt kit • .15 lbs. • To fit K9908910 & K9908870 	
\$2.65 ea.			
K9916650 (Left) K9916660 (Right)		<ul style="list-style-type: none"> • Deflector • To fit Claas® RU 600 8-row heads • 1 required • Left hand shown • 1.2 lbs. ea. 	9916650 9916660 Abrasion Resistant
\$15.30 ea.			
K9321500		<ul style="list-style-type: none"> • Comb feeder • To fit Claas® RU 600 & New Holland® RI 600 8-row heads • 6 required • .6 lbs. 	9321500 Abrasion Resistant
\$5.00 ea.			
K9997901		<ul style="list-style-type: none"> • Coupler • To fit Claas® RU 600 & New Holland® RI 600 8-row heads • 6 required • .5 lbs. 	9997901 Abrasion Resistant
\$8.00 ea.			
K9965390		<ul style="list-style-type: none"> • Replacement scraper disc • To fit Claas® RU 450XTRA heads, RU 450 heads & RU 600 heads from SN. 66101282 • AR400 Material • 6 required • 27.9 lbs. 	9965390 Abrasion Resistant
\$215.00 ea.			
K9921502		<ul style="list-style-type: none"> • Wear angle • To fit Claas® RU 450XTRA heads, RU 450 heads and RU 600 heads • 2 required • 1.8 lbs. 	9921502 Abrasion Resistant
\$8.75 ea.			
K9921511		<ul style="list-style-type: none"> • Wear angle • To fit Claas® RU 450XTRA heads, RU 450 heads and RU 600 heads • 2 required • 2.5 lbs. 	9921511 Abrasion Resistant
\$10.75 ea.			
K9923591 (Left) K9923611 (Right)		<ul style="list-style-type: none"> • Auger reinforcement • To fit Claas® RU 600 & RU 600 XTRA • 2 of each required • 4.5 lbs. 	9923591 9923611
\$125.75 ea.			
K54532835BK		<ul style="list-style-type: none"> • Auger reinforcement bolt kit • Used with K9923611 & K9923591 • One bolt kit per set • Set includes 25 bolts and 25 nuts 	
\$6.25 ea.			

TO ORDER CALL TOLL FREE 1-800-522-8874









KOOIMA® REPLACEMENT PARTS FOR CLAAS® RU 450XTRA HEADS

Replacement parts produced by Kooima® Company to fit Claas®

KOOIMA #	DESCRIPTION	REPLACES OEM #
K9995760 \$175.75 ea.	 <ul style="list-style-type: none"> • Skid plate • To fit Claas® RU 450XTRA • 3 required • 12.8 lbs. 	9995760 Abrasion Resistant
K9995771 \$12.75 ea.	 <ul style="list-style-type: none"> • Skid plate strap • To fit Claas® RU 450XTRA skid plate • 3 required • .4 lbs. 	9995771
K9322660 \$153.75 ea.	 <ul style="list-style-type: none"> • Center crop divider snoot • To fit Claas® RU 450XTRA 6-row heads • 2 required • 17 lbs. 	9322660
K9917810 (RH) K9917800 (LH) \$45.35 ea.	 <ul style="list-style-type: none"> • Feed guide • To fit Claas® RU 450XTRA heads • 2 required • 2.8 lbs. ea. 	9917810 9917800 Abrasion Resistant
K9922776 (LH) K9922846 (RH) \$136.30 ea.	 <ul style="list-style-type: none"> • Outside crop divider snoot • To fit Claas® RU 450XTRA heads • 1 required per side • Left hand shown • 9.8 lbs. ea. 	9922776 9922846
K9921490 \$7.25 ea.	 <ul style="list-style-type: none"> • Outside snoot wear plate • To fit Claas® RU 450XTRA heads • 2 required • .4 lbs. 	9921490 Abrasion Resistant
K9921782 \$80.45 ea.	 <ul style="list-style-type: none"> • Outside feed segment • To fit Claas® RU 450XTRA & RU 450 heads • 2 required • 13.4 lbs. 	9921782 Abrasion Resistant
K9921793 \$75.45 ea.	 <ul style="list-style-type: none"> • Center feed segment • To fit Claas® RU 450XTRA & RU 450 heads • 1 required • 8.7 lbs. 	9921793 Abrasion Resistant
K9909572 \$8.90 ea.	 <ul style="list-style-type: none"> • Intake cone tooth • To fit Claas® RU 450XTRA & RU 450 heads • 20 required • 1.6 lbs. 	9909572 Abrasion Resistant
K9990370 (99mm) (3 lbs.) \$23.80 ea. K9966431 (110mm) (3.6 lbs.) \$19.80 ea.	 <ul style="list-style-type: none"> • Auger tooth • To fit Claas® RU 450XTRA & RU 450 heads • 4 required • 99mm shown 	9990370 9966431 Abrasion Resistant

KOOIMA® REPLACEMENT PARTS FOR CLAAS® RU 450XTRA HEADS

Replacement parts produced by Kooima® Company to fit Claas®

KOOIMA #	DESCRIPTION	REPLACES OEM #
K9921502 \$8.75 ea.	 • Wear angle • To fit Claas® RU 450XTRA heads and RU 450 heads • 2 required • 1.8 lbs.	9921502 Abrasion Resistant
K9921511 \$10.75 ea.	 • Wear angle • To fit Claas® RU 450XTRA heads and RU 450 heads • 2 required • 2.5 lbs.	9921511 Abrasion Resistant
K9321200 (RH) K9321190 (LH) \$9.25 ea.	 • Replacement Claas® RU 450XTRA frame wear plate • To fit SN. 66005499 & below • 2.9 lbs.	9321200 9321190
K4976460 (RH) K4976470 (LH) \$28.30 ea.	 • Replacement Claas® RU 450XTRA corn header frame wear plate • 4.9 lbs.	4976460 4976470
K9965390 \$215.00 ea.	 • Replacement scraper disc • To fit Claas® RU 450XTRA heads, RU 450 heads & RU 600 heads from SN. 66101282 • AR400 Material • 6 required • 27.9 lbs.	9965390 Abrasion Resistant
K800WSC \$350.80 ea.	 • Windshield cover • 13.3 lbs. • To fit all Claas® 491, 492 & 493 series forage harvesters • To fit all 800 models & the 900 • Eliminates cracked and broken windshields • Double sewn heavy duty, padded vinyl construction • Stainless steel dee rings	

HAY PICK-UP TEETH

Kooima® hay pick-up teeth are manufactured from hi-tensile drawn spring wire for uniform strength and durability.



.7 lbs.

- Pick-up tooth
- To fit all Claas® forage harvester hay heads
- Replaces OEM # 9862900

Order # K2126290

\$3⁹⁵ ea.

- Replacement bushing for Claas® pickup heads
- To be welded to 9878060, 9866000, and 9838940 support roller brace

Order # K9878060B

\$18⁵⁵ ea.



.4 lbs.

- HP Pick-up tooth • .8 lbs.
- To fit all Claas® forage harvester hay heads
- Replaces OEM # 9862900

Order # K2126290HP

\$4⁹⁵ ea.



HP hay pick-up teeth are “shot peened,” giving them added strength!

K9903150
\$160.00 ea.



- Row crop disc
- To fit Claas® MG4, MG6 and MG8 corn heads • 4.9 lbs.

XQ9903150
**Heat Treated
Tungsten Carbide**

Order online at WWW.KOOIMA.COM and receive **FREE FREIGHT** to your door!

KOOIMA
COMPANY



High Quality Silage Covers

String Tarps White/Black - 8.0 mil (R8WBK)

Part #	Price	W X L	Weight
K8M84X200	\$1,300.00	84 X 200	600 lbs.
K8M84X250	\$1,600.00	84 X 250	750 lbs.



String Tarps White/Black - 6.0 mil (R6WBK)

Part #	Price	W X L	Weight
K59X200M6	\$892.50	59.5 X 200	370 lbs.
K59X500M6	\$2,231.25	59.5 X 500	780 lbs.
K85X250M6	\$1,607.85	85.75 X 250	585 lbs.
K85X1000M6	\$6,431.25	85.75 X 1000	2,275 lbs.
K105X40M6	\$316.50	105.5 X 40	172 lbs.
K105X60M6	\$474.75	105.5 X 60	237 lbs.
K151X45M6	\$511.35	151.5 X 45	220 lbs.
K151X50M6	\$568.15	151.5 X 50	250 lbs.
K151X60M6	\$681.75	151.5 X 60	272 lbs.
K151X70M6	\$795.40	151.5 X 70	315 lbs.
K151X75M6	\$852.20	151.5 X 75	335 lbs.
K151X80M6	\$909.00	151.5 X 80	370 lbs.
K151X100M6	\$1,136.25	151.5 X 100	430 lbs.
K184X70M6	\$968.65	184.5 X 70	405 lbs.
K184X110M6	\$1,522.15	184.5 X 110	550 lbs.
K204X50M6	\$765.95	204.25 X 50	315 lbs.
K204X60M6	\$919.15	204.25 X 60	380 lbs.
K204X70M6	\$1,072.35	204.25 X 70	420 lbs.
K204X80M6	\$1,225.50	204.25 X 80	465 lbs.
K204X100M6	\$1,531.90	204.25 X 100	550 lbs.
K243X60M6	\$1,096.90	243.75 X 60	455 lbs.
K250X70M6	\$1,313.85	250.25 X 70	545 lbs.
K250X80M6	\$1,501.50	250.25 X 80	590 lbs.
K250X85M6	\$1,595.35	250.25 X 85	615 lbs.
K303X100M6	\$2,272.50	303 X 100	870 lbs.



Detail of reinforced string tarps

Standard Silage Tarps White/Black - 5.0 mil (A5WB1)

Part #	Price	W X L	Weight
K57442	\$108.00	24 X 100	69 lbs.
K57443	\$144.00	32 X 100	90 lbs.
K57628	\$216.00	32 X 150	133 lbs.
K46534	\$180.00	40 X 100	110 lbs.
K57574	\$270.00	40 X 150	163 lbs.
K57575	\$360.00	40 X 200	216 lbs.
K50158	\$225.00	50 X 100	138 lbs.
K50159	\$337.50	50 X 150	203 lbs.
K54235	\$450.00	50 X 200	299 lbs.
K57576	\$270.00	60 X 100	161 lbs.
K53942	\$405.00	60 X 150	255 lbs.
K57577	\$540.00	60 X 200	346 lbs.
K64369	\$2,100.60	60 X 1000	1,557 lbs.
K69881	\$540.00	80 X 150	325 lbs.
K69880	\$720.00	80 X 200	455 lbs.
K70463	\$900.00	80 X 250	561 lbs.
K77059	\$2,800.80	80 X 1000	1,999 lbs.

1-800-522-8874

If you do not see the size you need, give us a call, other sizes are available upon request.

Prices are subject to change.

* Free shipping on Silage Covers if combined with \$750 in Kooima® parts on phone and internet orders

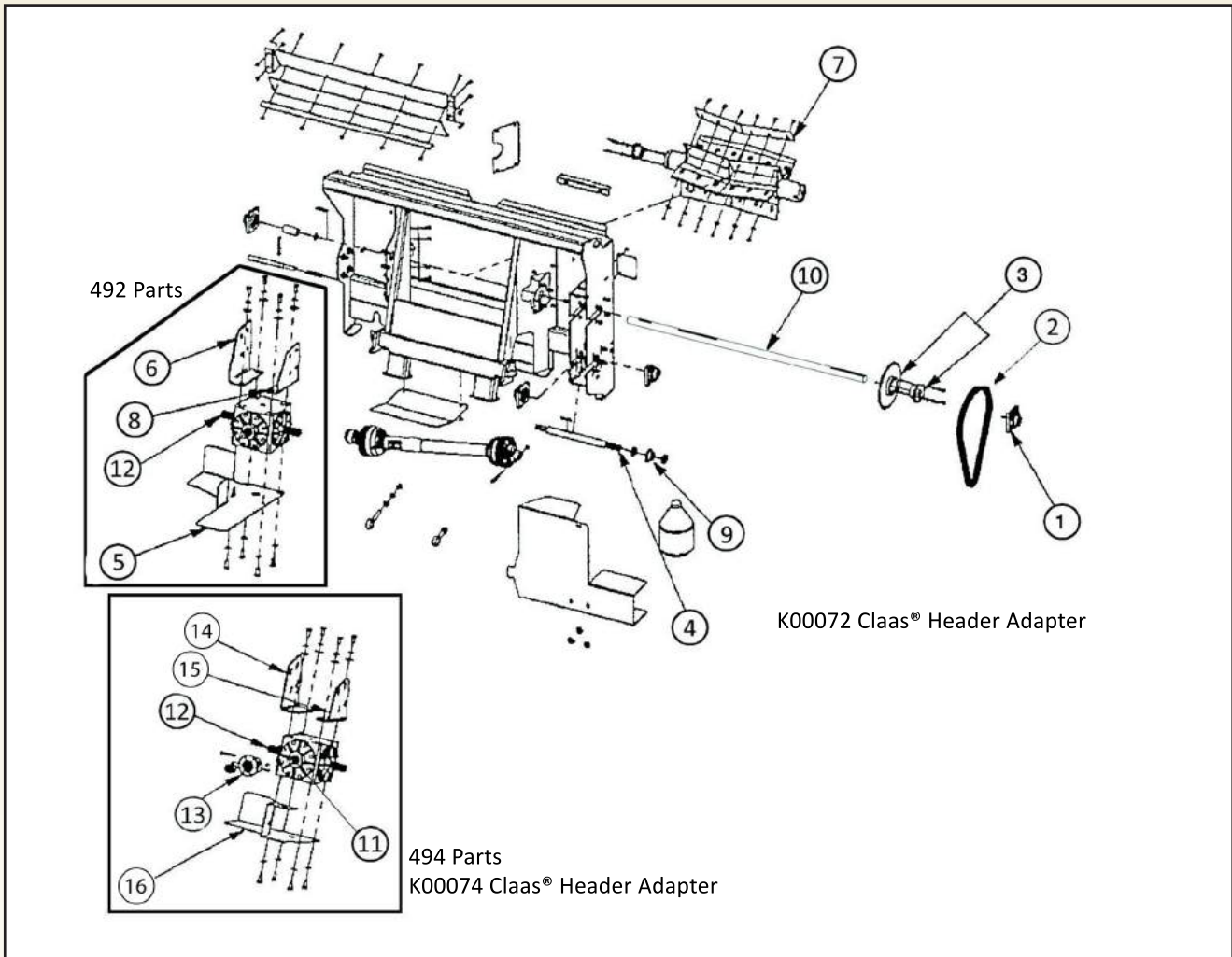

K00072 Claas® Header Adapter

494 Parts
K00074 Claas® Header Adapter

KOOIMA #	PRICE	DESCRIPTION
① 15-4BOLT-LC	\$75.45 ea.	• Bearing Ø 1.50", 4-bolt flange, lock collar • 4.75 lbs.
② 60CHAIN-64	\$65.45 ea.	• #60 roller chain, 64 pitches
③ 60SF45	\$110.75 ea.	• #60 sprocket, 45 tooth, squeeze hub • 12.1 lbs.
③ SFX1.5	\$40.35 ea.	• Squeeze hub, 1.50 shaft • 4.2 lbs.
④ FH002387	\$90.45 ea.	• Bottom shaft, Claas® adapter • 9.7 lbs.
⑤ FH002412	\$35.35 ea.	• PTO shield under gearbox • 22.7 lbs.
⑥ FH002416	\$25.30 ea.	• 492 gearbox bracket - left • 14.6 lbs.
⑦ FH002429	\$25.30 ea.	• Bolt-on tooth • 5 required • 7.6 lbs.
⑧ FH002433	\$25.30 ea.	• 492 gearbox bracket - right • 11.1 lbs.
⑨ 60B13-150	\$15.30 ea.	• 60 chain 13 tooth sprocket • 1.2 lbs.
⑩ FH003250	\$120.75 ea.	• This shaft replaces FH002427 and FH002386 • 30 lbs.
⑪ K302059	\$27.80 ea.	• Replacement gearbox V ring • .5 lbs.
⑪a K300459	\$16.00 ea.	• Seal • .05 lbs.
⑪b K101527	\$625.80 ea.	• 1 to 1 ratio bevel gear • 21 Tooth • 15.9 lbs.
Claas® 494 parts below		
⑫ FH002436	\$1,800.00 ea.	• Curtis 615MA Gearbox, 1:1.5, 1.75-20 splines • 170 lbs.
⑬ FH5001131	\$425.00 ea.	• Quick coupler assembly • 10.2 lbs.
⑭ FH002410	\$50.35 ea.	• 494 gearbox bracket - left • 13.1 lbs.
⑮ FH002423	\$50.35 ea.	• 494 gearbox bracket - right • 9.8 lbs.
⑯ FH002435	\$50.35 ea.	• PTO shield under gearbox • 17 lbs.

Truck icon signifies product is shipped via truck freight.

TO ORDER CALL TOLL FREE 1-800-522-8874



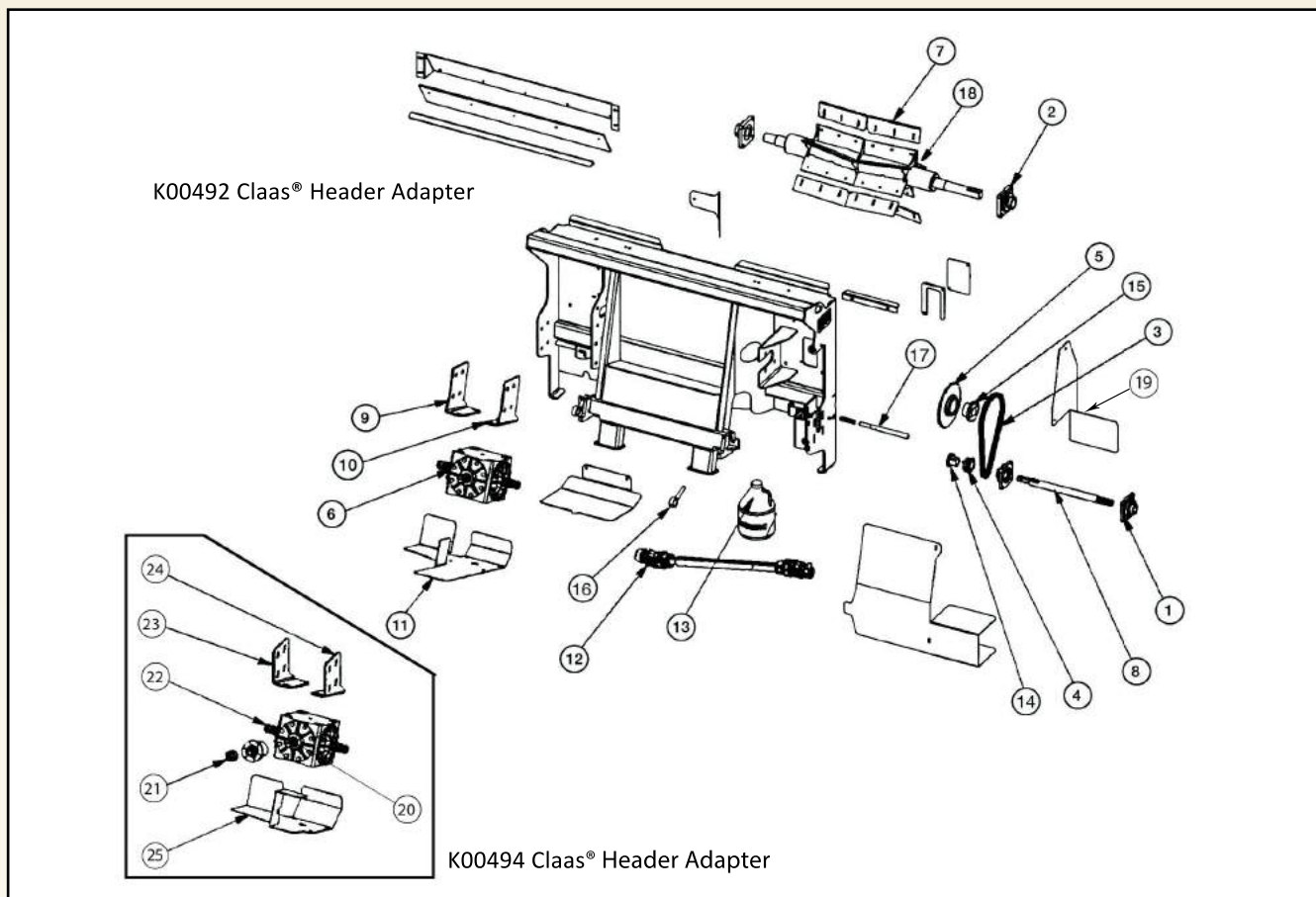

	KOOIMA #	PRICE	DESCRIPTION
①	15-4BOLT-LC	\$75.45 ea.	• Bearing Ø 1.50", 4-bolt flange, lock collar • 4.75 lbs.
②	20-4BOLT-LC	\$115.00 ea.	• Bearing, ball, 4-bolt flange, lock collar, 2.00 shaft • 7.15 lbs.
③	60H-62	\$50.35 ea.	• #60 heavy roller chain, 62 pitches • 4.8 lbs.
④	60P13H	\$50.35 ea.	• Squeeze style sprocket, #60-13 hardened • 1.35 lbs.
⑤	60SF42	\$70.45 ea.	• #60 sprocket, 42 tooth, QD hub • 10.5 lbs.
⑥	FH002436	\$1,800.00 ea.	• Curtis 615MA Gearbox, 1:1.5, 1.75-20 splines • 170 lbs.
⑦	FH002767	\$30.35 ea.	• Bolt-on tooth • 5 required • 5.8 lbs. • Bolt Kit: FH002767BK , \$2.65 ea.
⑧	FH002775	\$110.75 ea.	• Bottom shaft • 10.4 lbs.
⑨	FH002785	\$25.30 ea.	• Gearbox bracket - 492 left • 11.8 lbs.
⑩	FH002786	\$25.30 ea.	• Gearbox bracket - 492 right • 11.8 lbs.
⑪	FH002787	\$47.00 ea.	• PTO shield under gearbox • 23.4 lbs.
⑫	K00492PTO	\$490.00 ea.	• Middle PTO • 42 lbs.
⑬	75W-90PS	\$13.00 ea.	• 1 quart oil • 2 lbs. • 4 quarts needed
⑭	P11.5	\$35.35 ea.	• P1 bushing, for 1-1/2 shaft • 1 lb.
⑮	SFX2.0	\$25.30 ea.	• QD bushing, 2.00 shaft • 4 lbs.
⑯	FH5000940	\$60.45 ea.	• Adapter connector weldment - fits both 492 & 494 • 2 required • .95 lbs.
⑰	FH002304	\$25.30 ea.	• Lock pin, long - fits both 492 and 494 • 2.3 lbs.
⑱	FH5000973	\$650.80 ea.	• Flap wheel • 131 lbs.
⑲	FH003270	\$35.35 ea.	• Right hand side shield • 7.8 lbs.
Claas® 494 parts below			
⑳	K302059	\$27.80 ea.	• Replacement gearbox V ring • .5 lbs.
㉑	K300459	\$16.00 ea.	• Seal • .05 lbs.
㉒	K101527	\$625.80 ea.	• 1 to 1 ratio bevel gear • 21 Tooth • 15.9 lbs.
㉓	FH5001131	\$425.00 ea.	• Quick coupler assembly • 10.2 lbs.
㉔	FH002436	\$1,800.00 ea.	• Curtis 615MA Gearbox, 1:1.5, 1.75-20 splines • 170 lbs.
㉕	FH004264	\$90.00 ea.	• 494 gearbox bracket - left • 10.6 lbs.
㉖	FH004265	\$90.00 ea.	• 494 gearbox bracket - right • 9.9 lbs.
㉗	FH002783	\$80.45 ea.	• PTO shield under gearbox • 21.7 lbs.

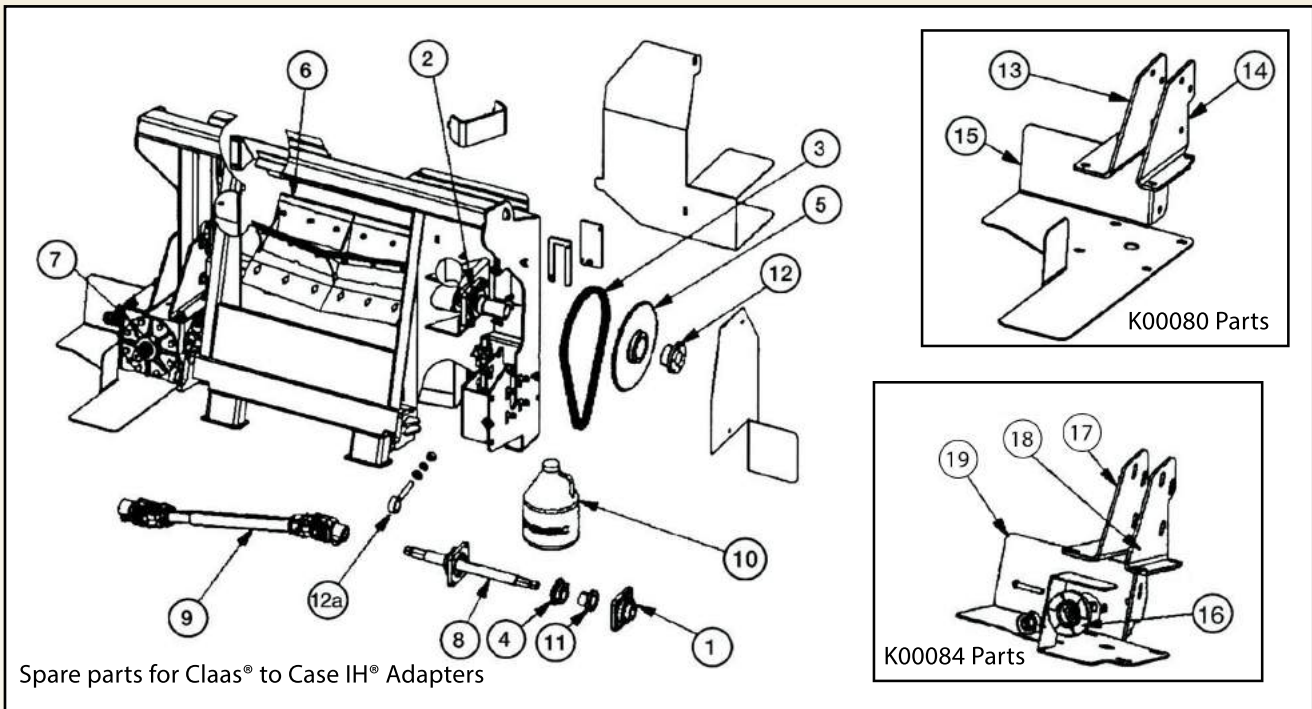

Spare parts for Claas® to Case IH® Adapters

	KOOIMA #	PRICE	DESCRIPTION
①	15-4BOLT-LC	\$75.45 ea.	• Bearing Ø 1.50", 4-bolt flange, lock collar • 4.75 lbs.
②	20-4BOLT-LC	\$115.00 ea.	• Bearing, ball, 4-bolt flange, lock collar, 2.00 shaft • 7.15 lbs.
③	60H-72	\$60.45 ea.	• #60 heavy roller chain, 72 pitches • 5.8 lbs.
④	60P15H	\$75.45 ea.	• Squeeze-style sprocket, #60 15 tooth hardened • 1.4 lbs.
⑤	60SF54	\$90.45 ea.	• #60 sprocket, 54 tooth, QD hub • 17.2 lbs.
⑥	FH002429R	\$30.35 ea.	• Bolt-on tooth • 5 required • 7.6 lbs.
⑦	FH002436	\$1,800.00 ea.	• Curtis 615MA Gearbox, 1:1.5, 1.75-20 splines • 170 lbs.
⑦a	K302059	\$27.80 ea.	• Replacement gearbox V ring • .5 lbs.
⑦b	K300459	\$16.00 ea.	• Seal • .05 lbs.
⑦c	K101527	\$625.80 ea.	• 1 to 1 ratio bevel gear • 21 Tooth • 15.9 lbs.
⑧	FH002530	\$115.75 ea.	• 1-1/2 stub shaft • 9.4 lbs.
⑨	K00080PTO	\$490.00 ea.	• PTO for Claas®/Case-IH® adapter • 28.7 lbs.
⑩	75W-90PS	\$13.00 ea.	• 1 quart oil • 2 lbs. • 4 quarts needed
⑪	P11.5	\$35.35 ea.	• P1 bushing, for 1-1/2 shaft • 1 lb.
⑫	SFX2.0	\$25.30 ea.	• QD bushing, 2.00 shaft • 4 lbs.
⑫a	FH5000940	\$60.45 ea.	• Adapter connector weldment • 2 required • .95 lbs.
K00080 parts below			
⑬	FH002508	\$30.35 ea.	• K00080 gearbox bracket - left • 13.9 lbs.
⑭	FH002509	\$30.35 ea.	• K00080 gearbox bracket - right • 10 lbs.
⑮	FH002541	\$35.00 ea.	• PTO shield under gearbox, K00080 • 27.9 lbs
K00084 parts below			
⑯	FH5001131	\$425.00 ea.	• Quick coupler assembly • 10.2 lbs.
⑰	FH002511	\$50.35 ea.	• K00084 gearbox bracket - left • 13.2 lbs.
⑱	FH002512	\$50.35 ea.	• K00084 gearbox bracket - right • 100.2 lbs.
⑲	FH002542	\$50.35 ea.	• PTO shield under gearbox, K00084 • 22.25 lbs.

Truck icon signifies product is shipped via truck freight.













Order online at WWW.KOOIMA.COM and receive **FREE FREIGHT** to your door!



Kooima® Replacement Parts To Fit KRONE®

KOOIMA® REPLACEMENT PARTS FOR KRONE® FORAGE HARVESTERS

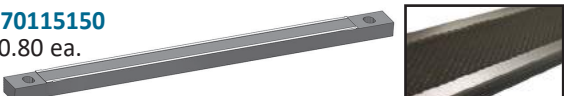
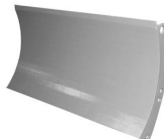













Krone® and Big X® are registered trademarks of Bernard Krone Holding, GmbH & Co. KG, which does not manufacture, distribute or endorse these parts.

KOOIMA #	DESCRIPTION	REPLACES OEM #
KR3507730 (RH) KR3507720 (LH) \$42.25 ea.	 <ul style="list-style-type: none"> • Corn knife • To fit Krone® Big X® series harvesters • 4.6 lbs. 	3507730 / 202230960 3507720 / 202231000 Heat Treated/ Tungsten Carbide
KR3507710 (RH) KR3507700 (LH) \$47.50 ea.	 <ul style="list-style-type: none"> • Grass knife • 4.8 lbs. • To fit Krone® Big X® series harvesters • 4.8 lbs. 	3507710 3507700 Heat Treated/ Tungsten Carbide
KR202251542 (RH) KR202251532 (LH) \$51.75 ea.	 <ul style="list-style-type: none"> • Narrow body grass knife • 4.8 lbs. • To fit Krone® 480, 530, 580 & 680 series • Left hand shown • 3.4 lbs. 	202251542 / 20221182 202251532 / 202261172 Heat Treated/ Tungsten Carbide
KR202251552 (LH) KR202251562 (RH) \$51.75 ea.	 <ul style="list-style-type: none"> • Narrow body corn knife • 4.8 lbs. • To fit Krone® 480, 530, 580 & 680 series • Left hand shown • 3.2 lbs. 	202251552 / 202261192 202251562 / 202261202 Heat Treated/ Tungsten Carbide
KR204245490 \$9.25 ea.	 <ul style="list-style-type: none"> • Cutterhead knives top strap • 1.7 lbs. • To fit Krone® 480, 530, 580 & 680 series 	20424549.0
K9871982BK \$2.10 ea.	 <ul style="list-style-type: none"> • Knife bolt • .25 lbs. • To fit Krone® wide and narrow body harvesters 	9003230
KR2195561 \$19.50 ea.	 <ul style="list-style-type: none"> • Cutterhead knives - top strap • To fit Krone® Big X® series forage harvesters • 2 lbs. 	2195561 Abrasion Resistant
KR2195553 \$15.30 ea.	 <ul style="list-style-type: none"> • Replacement nut • To fit Krone® Big X® series forage harvesters • 3.7 lbs. 	2195553
KR2242613HP \$800.00 ea.	 <ul style="list-style-type: none"> • High performance shearbar • To fit all Krone® Big X® series harvesters • For use in hay or corn • 28.8 lbs. • Bolt Kit: KR2242613HPBK, \$20.30 ea. 	2242613 Heat Treated Tungsten Carbide
KR270115140 \$450.80 ea.	 <ul style="list-style-type: none"> • Grass shearbar • 21 lbs. • To fit Krone® 480, 530, 580 & 680 narrow body 	270115140 Heat Treated Tungsten Carbide
KR270115150 \$630.80 ea.	 <ul style="list-style-type: none"> • Koyma Klad® hi-performance corn shearbar • 22 lbs. • To fit Krone® 480, 530, 580 & 680 narrow body 	270115150 Heat Treated Tungsten Carbide
KR2163951 \$290.75 ea.	 <ul style="list-style-type: none"> • Cutterhead floor plate • To fit Krone® Big X® series forage harvesters • Serial # 57001-600600 • 55.7 lbs. 	2163951 Abrasion Resistant
KR2156440 \$105.95 ea.	 <ul style="list-style-type: none"> • Transfer tunnel wear plate • 26.5 lbs. • To fit Krone® Big X® series forage harvesters • Serial # 600601 and above • Bolt Kit: KR2156440BK, \$12.75 ea. 	2156440 Abrasion Resistant
KR2223643 \$50.35 ea.	 <ul style="list-style-type: none"> • Sharpening stone • To fit Krone® Big X® series forage harvesters • 4.6 lbs. 	2223643

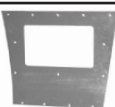
Replacement parts produced by Kooima® Company to fit Krone®

KOOIMA® REPLACEMENT PARTS FOR KRONE® FORAGE HARVESTERS

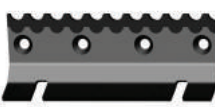
Replacement parts produced by Kooima® Company to fit Krone®

KOOIMA #	DESCRIPTION	REPLACES OEM #
KR2161980 \$32.85 ea. 	<ul style="list-style-type: none"> Replacement upper feed roll tooth To fit Krone® Big X® 500, 650, 800, 1000, V8, V12, LG 730mm 10 required • 3.3 lbs. 	2161981 Stainless Steel
KR200261090 \$21.10 ea. 	<ul style="list-style-type: none"> Upper feed roll tooth To fit Krone® Big X® 850, 700, 1100, LG 710mm 10 required • Use KR2161980BK bolt kit • 2.4 lbs. 	200261090 Stainless Steel
KR2161980BK \$60.45 ea. 	<ul style="list-style-type: none"> Feed roll tooth bolt kit Use with upper feed roll tooth Each kit includes stainless steel bolts, washers & nuts (70 each) • 5.8 lbs. 	
KR200224180 \$23.75 ea. 	<ul style="list-style-type: none"> Lower front feed roll tooth To fit Krone® Big X® series forage harvesters • 14 required • .9 lbs. 	
KR200224180BK \$70.45 ea. 	<ul style="list-style-type: none"> Feed roll tooth bolt kit • 3.6 lbs. Use with lower feed roll tooth • Stainless steel bolts, washers & nuts (98 each) 	
KR2156710 \$30.35 ea. 	<ul style="list-style-type: none"> Replacement wear plate for feed chute • 10.3 lbs. To fit Krone® Big X® series forage harvesters Serial # 600601 and above • Bolt Kit: KR2156710BK, \$18.30 ea. 	2156710 Abrasion Resistant
KR2156721 (Right) KR2156731 (Left) \$13.30 ea. 	<ul style="list-style-type: none"> Feed chute wear plate • 3.7 lbs. ea. To fit Krone® Big X® series forage harvesters Serial # 600601 and above • Bolt Kit: KR2156721BK, \$6.25 ea. 	2156721 2156731 Abrasion Resistant
KR2156740 \$25.30 ea. 	<ul style="list-style-type: none"> Transition wear plate • 6.6 lbs. To fit Krone® Big X® series forage harvesters Serial # 600601 and above • Bolt Kit: KR2156440BK, \$12.75 ea. 	2156740 Abrasion Resistant
KR2157011 \$150.75 ea. 	<ul style="list-style-type: none"> Grass channel wear plate • 29.4 lbs. To fit Krone® Big X® series forage harvesters Serial # 600601 and above • Bolt Kit: KR2157011BK, \$30.35 ea. 	2157011 Abrasion Resistant
KR2157031 (Right) KR2157021 (Left) \$15.30 ea. 	<ul style="list-style-type: none"> Grass chute liner • 8.1 lbs. ea. • Right hand shown To fit Krone® Big X® series forage harvesters Serial # 600601 and above • Bolt Kit: KR2157031BK, \$5.25 ea. 	2157031 2157021 Abrasion Resistant
KR2157041 \$38.35 ea. 	<ul style="list-style-type: none"> Grass chute wear plate • 12 lbs. To fit Krone® Big X® series forage harvesters Serial # 600601 and above • Bolt Kit: KR2157041BK, \$15.30 ea. 	2157041 Abrasion Resistant
KR2166941 \$30.35 ea. 	<ul style="list-style-type: none"> Processor housing wear plate • 5.4 lbs. To fit Krone® Big X® series forage harvesters Serial # 600601 and above • Bolt Kit: KR2166941BK, \$4.00 ea. 	2166941 Abrasion Resistant
KR2161320 (Right) KR2161330 (Left) \$20.30 ea. 	<ul style="list-style-type: none"> Accelerator paddles • 3.4 lbs. ea. To fit Krone® Big X® series forage harvesters equipped with 3 paddle blower system 6 left & 6 right required • Left hand shown Bolt Kit: KR2161320BK, \$150.75 ea., 1 kit = 12 paddles 	2161321/2161320 2161331/2161330 Heat Treated Tungsten Carbide
KR2161330HP \$25.30 ea. 	<ul style="list-style-type: none"> Hi-performance accelerator paddle To fit Krone® Big X® series forage harvesters • Keeps the blower housing cleaner and provides more air volume • 12 required • 3.5 lbs. Koyma Klad® coatings are built to outlast any other coatings. Designed with you in mind! Just one of our many extended life products. 	Heat Treated/Tungsten Carbide
KR200231950 (Right) KR200231960 (Left) \$59.35 ea. 	<ul style="list-style-type: none"> Accelerator paddles To fit Krone® Big X® series forage harvesters equipped with 8 paddle blower system 4 left & 4 right required Left hand shown • 3.3 lbs. 	200231951/200231950 200231961/200231960 Heat Treated/ Tungsten Carbide

Bolt kit: KR200231950BK - \$55.35, 1 kit = 8 paddles, 6.5 lbs.

Order online at WWW.KOOIMA.COM and receive **FREE FREIGHT** to your door!

KOOIMA®
COMPANY



KOOIMA® REPLACEMENT PARTS FOR KRONE® FORAGE HARVESTERS

Replacement parts produced by Kooima® Company to fit Krone®

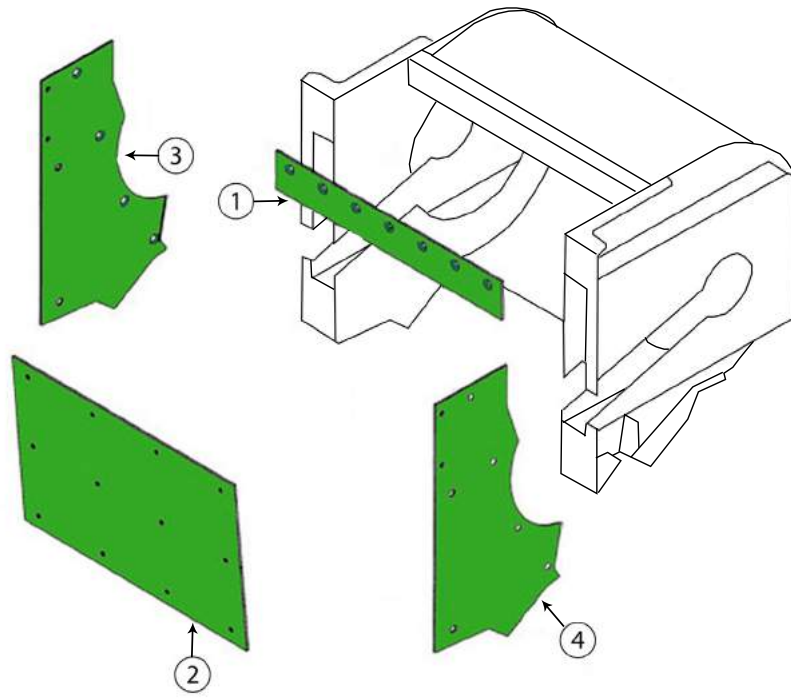

KOOIMA #	DESCRIPTION	REPLACES OEM #
KR2158031	<ul style="list-style-type: none"> Accelerator housing scraper • 6.8 lbs. To fit Krone® Big X® series forage harvesters Serial # 600601 and above • Bolt Kit: KR2158031BK, \$6.25 ea. 	2158031 Abrasion Resistant
\$27.80 ea.		
KR2157141	<ul style="list-style-type: none"> Accelerator housing door liner • 32 lbs. To fit Krone® Big X® series forage harvesters Serial # 600601 and above • Bolt Kit: KR2157141BK, \$40.35 ea. 	2157141 Abrasion Resistant
\$60.00 ea.		
KR2157231	<ul style="list-style-type: none"> Left hand accelerator housing side liner • 14.60 lbs. To fit Krone® Big X® series forage harvesters Serial # 600601 and above • Bolt Kit: KR2157231BK, \$16.30 ea. 	2157232 Abrasion Resistant
\$35.35 ea.		
KR2157220	<ul style="list-style-type: none"> Right hand accelerator housing side liner • 14.60 lbs. To fit Krone® Big X® series forage harvesters Serial # 600601 and above • Bolt Kit: KR2157231BK, \$16.30 ea. 	2157222 Abrasion Resistant
\$35.35 ea.		

KOOIMA #	DESCRIPTION	REPLACES OEM #
KR2156591HPF (Fast 110 tooth)	<ul style="list-style-type: none"> Kernel processor roll To fit Krone® Big X® harvesters 224 lbs.  Get the real value out of your processor with the new Chevron Series Fiber Tech High Capacity Rolls Chromed Plated Roll 	2156591 Heat Treated
KR2156591HPS (Slow 138 tooth)		

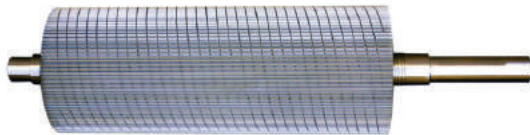

\$2,265.00 ea.

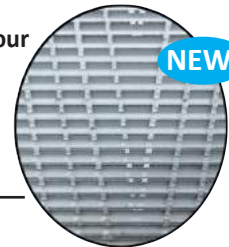

NEW! Square grooves unwrap cellulose and shred your stalk which also creates a far superior process job.

KR20223040 (Fast 110 tooth)	<ul style="list-style-type: none"> Kernel processor roll To fit Krone® 480, 530, 580 & 680 harvesters 169.5 lbs. Chevron Series Fiber Tech - High Capacity Rolls Chromed Plated Roll 	202230401
KR20223038 (Slow 138 tooth)		202230381
\$2,190.00 ea.		Heat Treated 

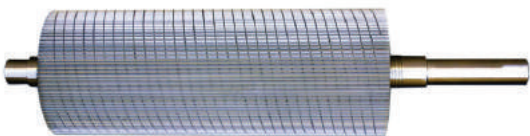

KRBEARING	<ul style="list-style-type: none"> Kernel processor bearing To fit all Krone® harvesters 2.6 lbs.
\$125.75 ea.	



KOOIMA® REPLACEMENT PARTS FOR KRONE® FORAGE HARVESTERS

Replacement parts produced by Kooima® Company to fit Krone®

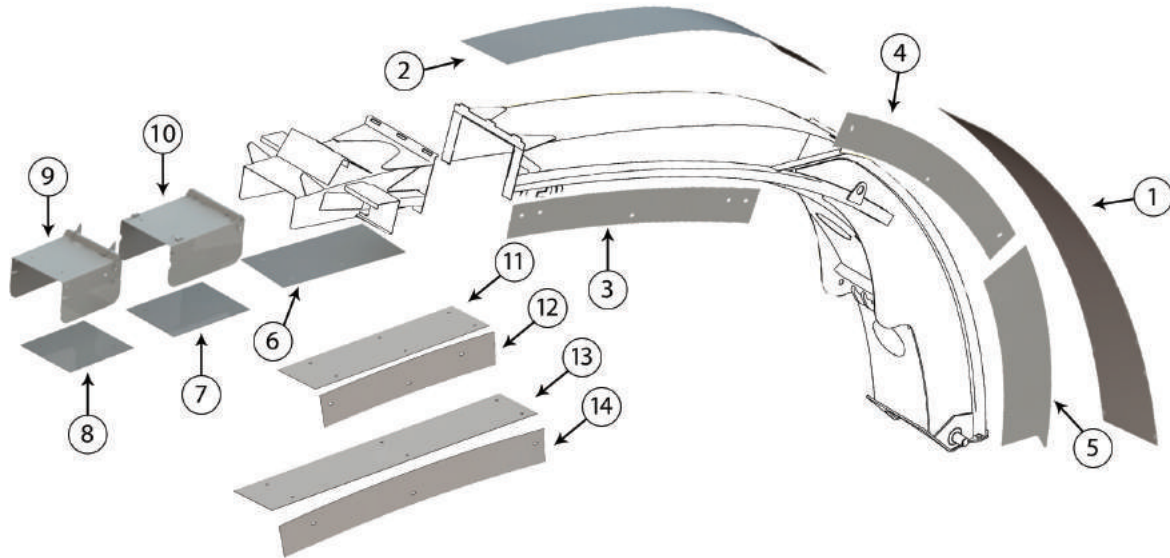

KOOIMA #	DESCRIPTION	REPLACES OEM #
KR2173473 \$150.75 ea.	① • Reversible spout back liner • 1 required • 78 lbs. • To fit Krone® factory spout • Bolt Kit: KR2173473BK , \$60.45 ea.	2173473 Abrasion Resistant
KR2260893 \$150.75 ea.	② • Mid section wear liner • 31.3 lbs. • To fit Krone® factory spout • Bolt Kit: KR2260893BK , \$5.00 ea.	2260893 Stainless Steel
KR2225922 \$49.35 ea.	③ • Upper spout side liner • 15 lbs. • To fit Krone® factory spout • Bolt Kit: KR2225922BK , \$7.25 ea.	2225922 Abrasion Resistant
KR2260902 \$55.35 ea.	④ • Middle spout side liner • 13.3 lbs. • To fit Krone® factory spout • Bolt Kit: KR2260902BK , \$4.50 ea.	2260902 Abrasion Resistant
KR2260882 \$71.95 ea.	⑤ • Bottom side liner • 23.3 lbs. • To fit Krone® factory spout • Bolt Kit: KR2260882BK , \$7.25 ea.	2260882 Abrasion Resistant
KR2287510 \$55.35 ea.	⑥ • 30" extension liner • 9.7 lbs. • To fit Krone® factory spout • Bolt Kit: KR2287510BK , \$4.25 ea.	2287510 Stainless Steel
KR2158660 \$40.35 ea.	⑦ • Spout deflector wear plate • 11.7 lbs. • To fit KR2158762 inner spout deflector	2158660 Abrasion Resistant
KBK \$3.25 ea.	⑦a • Hardware kit • .1 lbs. • To fit KR2158660 spout deflector wear plate	
KR2158770 \$50.35 ea.	⑧ • Spout deflector wear plate • 10.5 lbs. • To fit KR2158320 outer spout deflector	2158770 Abrasion Resistant
KBK \$3.25 ea.	⑧a • Hardware kit • .1 lbs. • To fit KR2158770 spout deflector wear plate	
KR2158320 \$97.45 ea.	⑨ • Outer spout deflector • 20.9 lbs. • To fit all Krone® harvesters • Non folding spouts only • Bolt Kit: KR2158320BK , \$12.25 ea.	2158321
KR2158762 \$97.45 ea.	⑩ • Inner spout deflector • 22.2 lbs. • To fit all Krone® harvesters • Non folding spouts only • Bolt Kit: KR2158762BK , \$11.25 ea.	2158762
KR2261163 \$49.85 ea.	⑪ • 10 row extension liner • 13.25 lbs. • To fit Krone® factory extension • 37.75" Long • Bolt Kit: KR2261163BK , \$4.25 ea.	2261163 Stainless Steel
KR2261174 \$29.80 ea.	⑫ • 10 row extension side liner • 7 lbs. • To fit Krone® factory extension • 2 required • Bolt Kit: KR2260902BK , \$4.50 ea.	2261174 Stainless Steel
KR2196842 \$69.45 ea.	⑬ • 12 row extension liner • 20 lbs. • To fit Krone® factory extension • 57.50" Long • Bolt Kit: KR2261163BK , \$4.25 ea.	2196842 Stainless Steel
KR2196853 \$45.35 ea.	⑭ • 12 row extension side liner • 10.6 lbs. • To fit Krone® factory extension • 2 required • Bolt Kit: KR2260902BK , \$4.50 ea.	2196853 Stainless Steel

TO ORDER CALL TOLL FREE 1-800-522-8874



KOOIMA® REPLACEMENT PARTS FOR KRONE® EASYCOLLECT 6000, 7500, 9000

Krone® is a registered trademark of Bernard Krone Holding, GmbH & Co. KG, which does not manufacture, distribute or endorse these parts.

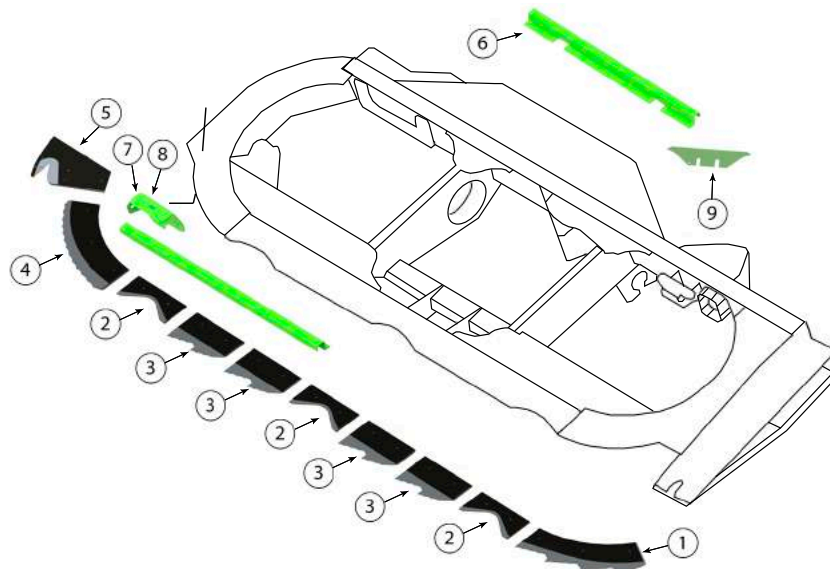

Replacement parts produced by Kooima® Company to fit Krone®

KOOIMA #		DESCRIPTION	REPLACES OEM #
KR3523076 (LH)	①	• Knife	3523077/3523076
KR3523086 (RH)		• To fit Krone® Easycollect 6000, 7500 & 9000 series	3523087/3523086
\$167.00 ea.		• 1 required per side for all models listed • 8.7 lbs.	Abrasion Resistant/Tungsten Carbide
KR3523133BK	①a	• Bolt kit for KR3523076 & KR3523086 • .15 lbs.	
\$4.00 ea.		• To fit Krone® Easycollect 6000, 7500 & 9000 series	
KR3523094	②	• Knife • 3.2 lbs.	3523095/3523094
\$70.00 ea.		• To fit Krone® Easycollect 6000, 7500 & 9000 series	Abrasion Resistant Tungsten Carbide
KR3523054BK	②a	• 6000: 6 required; 7500: 8 req.; 9000: 10 req.	
\$4.00 ea.		• Bolt kit for KR3523094 • .1 lbs.	
KR3523054 (LH)		• To fit Krone® Easycollect 6000, 7500 & 9000 series	
KR3523065 (RH)	③	• Knife • 5.2 lbs.	3523055/3523054
\$79.00 ea.		• To fit Krone® Easycollect 6000, 7500 & 9000 series	3523066/3523065
KR3523054BK	③a	• 6000: 4 required per side; 7500: 6 req. per side	Abrasion Resistant Tungsten Carbide
\$4.00 ea.		• 9000: 8 required per side	
KR3523133 (LH)		• Bolt kit for KR3523054 & KR3523065 • .1 lbs.	
KR3523143 (RH)	④	• Inside Knife	3523134/3523133
\$167.00 ea.		• To fit Krone® Easycollect 6000, 7500 & 9000 series	3523144/3523143
KR3523133BK	④a	• 1 required per side for all models listed • 9.2 lbs.	Abrasion Resistant/Tungsten Carbide
\$4.00 ea.		• Bolt kit for KR3523133 & KR3523143 • .15 lbs.	
KR3523113 (LH)		• To fit Krone® Easycollect 6000, 7500 & 9000 series	
KR3523103 (RH)	⑤	• V Knife	3523114/3523113
\$167.00 ea.		• To fit Krone® Easycollect 6000, 7500 & 9000 series	3523104/3523103
KR3523103BK	⑤a	• 1 required per side for all models listed • 7.1 lbs.	Abrasion Resistant/ Tungsten Carbide
\$4.00 ea.		• Bolt kit for KR3523103 and KR3523113	
KR3524213	⑥	• To fit Krone® Easycollect 6000, 7500 & 9000 series • .25 lbs.	200932762/3524213
\$50.35 ea.		• Angle	
KR3524203	⑥a	• To fit Krone® Easycollect 6000 series • 4 required • 17.7 lbs.	200932732/3524203
\$67.45 ea.		• Angle	
KR3524223	⑥b	• To fit Krone® Easycollect 7500 series • 4 required • 28 lbs.	3524223
\$77.45 ea.		• Angle	
KR3527981	⑦	• To fit Krone® Easycollect 9000 series • 4 required • 37.6 lbs.	3527982/3527981
\$8.00 ea.		• Right hand guard	
KR3527971	⑧	• 1.5 lbs.	3527972/3527971
\$8.00 ea.		• Left hand guard	
KH100001	⑨	• 1.5 lbs.	Tungsten Carbide
\$64.20 ea.		• Knife Scraper	
		• To fit Krone® Easycollect 6000, 7500 & 9000 series • 2 required • 3.2 lbs.	

HEAD KITS

KREC6000 \$2,095.00 ea.	• Head Kit - Includes knives, scrapers and bolt kits • To fit Krone® Easycollect® 6000
KREC7500 \$2563.50 ea.	• Head Kit - Includes knives, scrapers and bolt kits • To fit Krone® Easycollect® 7500
KREC9000 \$3,032.00	• Head Kit - Includes knives, scrapers and bolt kits • To fit Krone® Easycollect® 9000

KOOIMA® REPLACEMENT PARTS FOR KRONE® EASYCOLLECT 6000, 7500, 9000

Replacement parts produced by Kooima® Company to fit Krone®

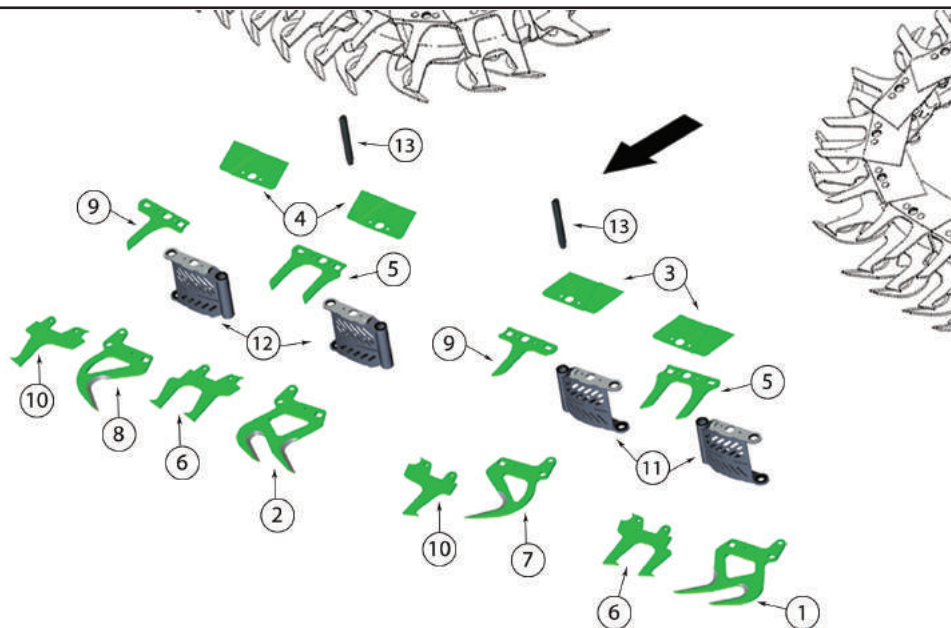

<u>KOOIMA #</u>	<u>DESCRIPTION</u>	<u>REPLACES OEM #</u>
KR3523033 (LH) KR3523043 (RH) \$60.00 ea.	① • Blade • 4.3 lbs. • To fit Krone® Easycollect 6000, 7500 & 9000 series • 6000: 15 required per side; 7500: 19 req. per side • 9000: 23 required per side	3523033 3523043 Abrasion Resistant Tungsten Carbide
KR3521501 (LH) KR3521511 (RH) \$4.00 ea.	③ • Cover • 1 lb. ea. • To fit Krone® Easycollect 6000, 7500 & 9000 series • 6000: 31 req. per side; 7500: 39 req. per side; 9000: 47 req. per side	3521501 3521511
KR3521413 \$5.25 ea.	⑤ • Top wrapping finger • 2 lbs. • To fit Krone® Easycollect 6000, 7500 & 9000 series • 6000: 16 req. per head; 7500: 20 req. per head; 9000: 24 req. per head	3521413 Abrasion Resistant
KR3521432 \$10.60 ea.	⑥ • Bottom wrapping finger • 2.5 lbs. • To fit Krone® Easycollect 6000, 7500 & 9000 series • 6000: 16 req. per head; 7500: 20 req. per head; 9000: 24 req. per head	3521432 Abrasion Resistant
KR3523013 (LH) KR3523023 (RH) \$50.35 ea.	⑦ • Blade • 3.3 lbs. • To fit Krone® Easycollect 6000, 7500 & 9000 series • 6000: 16 req. per side; 7500: 20 req. per side • 9000: 24 req. per side	3523013 3523023 Abrasion Resistant Tungsten Carbide
KR3521402 \$4.75 ea.	⑨ • Top finger • 1.4 lbs. • To fit Krone® Easycollect 6000, 7500 & 9000 series • 6000: 15 req. per head; 7500: 19 req. per head; 9000: 23 req. per head	3521402 Abrasion Resistant
KR3521422 \$5.25 ea.	⑩ • Bottom finger • 1.9 lbs. • To fit Krone® Easycollect 6000, 7500 & 9000 series • 6000: 15 req. per head; 7500: 19 req. per head; 9000: 23 req. per head	3521422 Abrasion Resistant
KH200060 (LH) KH200061 (RH) \$120.75 ea.	⑪ • Connector link • 6.22 lbs. • To fit Krone Easycollect 6000, 7500 & 9000 series • 6000: 31 req. per side; 7500: 39 req. per side; 9000: 47 req. per side • Price includes bearings and seals already pressed in the link	3521544 3521534 Tungsten Carbide
KH100005 \$19.30 ea.	⑬ • Collector pin • 1.55 lbs. • To fit Krone Easycollect 6000, 7500 & 9000 series • 6000: 31 req. per side; 7500: 39 req. per side; 9000: 47 req. per side	3516343 Heat Treated

<u>KOOIMA #</u>	<u>DESCRIPTION</u>	<u>REPLACES OEM #</u>
KR3524353 \$50.35 ea.	• Star plate • 8 required • 17.8 lbs. • To fit Krone® Easycollect 6000, 7500 & 9000 series	3524353

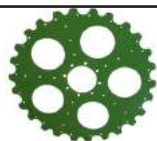

KH200015-01 \$6.75 ea.	• Replacement plastic collector • .15 lbs. • Bolt in between KR3524353 star plates • 52 required per head	3511544
----------------------------------	---	---------



Order online at WWW.KOOIMA.COM and receive **FREE FREIGHT** to your door!



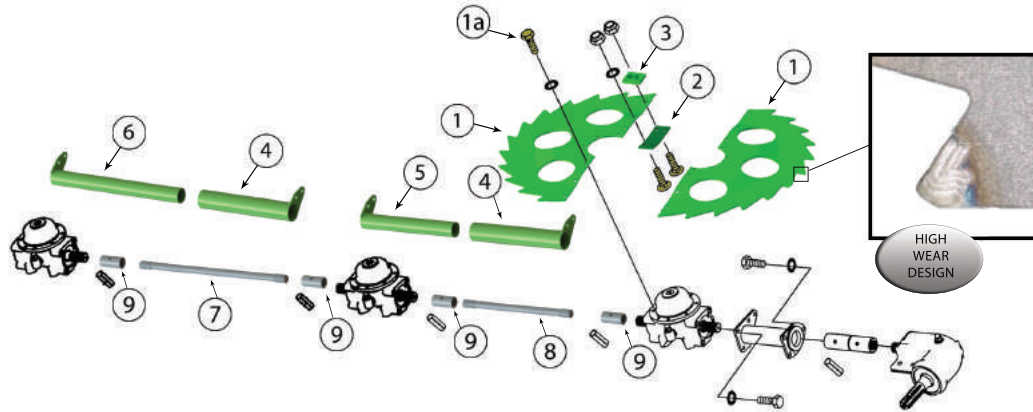

KOOIMA® REPLACEMENT PARTS FOR KRONE® EASYCOLLECT 6000, 7500, 9000

Replacement parts produced by Kooima® Company to fit Krone®



KOOIMA #	DESCRIPTION	REPLACES OEM #
KR3520753 (LH) KR3520743 (RH) \$57.35 ea.	① • Dresser Segment • To fit Krone® Easycollect 6000, 7500 & 9000 series • 6000: 6 required; 7500: 8 req.; 9000: 10 req. • 8.6 lbs. ea.	3520753 3520743
KR3520743BK \$7.00 ea.	①a • Bolt kit for KR3520753 and KR3520743 • 1 required per set • To fit Krone® Easycollect 6000, 7500 & 9000 series • .75 lbs.	
KR3520761 \$4.75 ea.	② • Bracket • To fit Krone® Easycollect 6000, 7500 & 9000 series • 6000: 12 required; 7500: 16 req.; 9000: 20 req. • .35 lbs.	3520761
KR3520761HP \$15.30 ea.	②a • High performance bracket • To fit Krone® Easycollect 6000, 7500 & 9000 series • Koyma Klad® coating • Customer requested! • .55 lbs. • Improved heavy duty design for durability • Extra thick steel for superior performance in the field	3520761 Tungsten Carbide
KR3520761HPBK \$7.00 ea.	②b • Bolt kit for KR3520761HP • 1 bolt kit = 2 brackets • .39 lbs. • To fit Krone® Easycollect 6000, 7500 & 9000 series • Kit contains 8 bolts, 8 lock nuts & 8 spring washers	
KR3520772 \$6.50 ea.	③ • Scraper • To fit Krone® Easycollect 6000, 7500 & 9000 series • 6000: 12 required; 7500: 16 req.; 9000: 20 req. • .35 lbs.	3520774/3520772 Heat Treated
KR3520772HP \$17.80 ea.	③a • High performance scraper • Koyma Klad® coating • .5 lbs. • Thicker to protect the bolts and will last longer • To fit Krone® Easycollect 6000, 7500 & 9000 series	3520774/3520772 Heat Treated Tungsten Carbide
KR3524801 \$21.80 ea.	④ • Protective tube outside • 5.35 lbs. • To fit Krone® Easycollect 6000, 7500 & 9000 series • 6000: 4 required; 7500: 6 req.; 9000: 8 req.	3524801
KR3524811 \$20.30 ea.	⑤ • Protective tube inside • 4.2 lbs. • To fit Krone® Easycollect 6000, 7500 & 9000 series • 6000: 2 required; 7500: 4 req.; 9000: 6 req.	3524811
KR3524861 \$22.80 ea.	⑥ • Protective tube inside • 5.7 lbs. • To fit Krone® Easycollect 6000, 7500 & 9000 series • 6000: 2 required; 7500: 2 req.; 9000: 2 req.	3524861
KR3521150 \$90.45 ea.	⑦ • Connecting shaft • 5.4 lbs. • To fit Krone® Easycollect 6000, 7500 & 9000 series • 2 required • 22.40" long	3521150
KR3521051 \$75.45 ea.	⑧ • Connecting shaft • 4.0 lbs. • Krone® Easycollect 6000: 2 required, 7500: 4 required, 9000: 6 required • 16.50" long	3521051
KR3521063 \$36.10 ea.	⑨ • Connecting shaft collar • .8 lbs. • Krone® Easycollect 6000: 8 required, 7500: 12 required, 9000: 16 required	3521063

KOOIMA #	DESCRIPTION	REPLACES OEM #
KR3528972 (LH) KR3528982 (RH) \$100.75 ea.	 • Side nose, used with augers • To fit Krone® Easycollect 6000, 7500 & 9000 series • Right hand shown • 15.2 lbs.	3528972 3528982

KR3525012 \$70.45 ea.	 • Middle point • To fit Krone® Easycollect 6000, 7500 & 9000 series • 9.8 lbs.	3525012 3525013
---------------------------------	--	--------------------

KR3525461 \$75.45 ea.	 • Tip • To fit Krone® Easycollect 6000, 7500 & 9000 series • 7.6 lbs.	3525461
---------------------------------	---	---------

KOOIMA® REPLACEMENT PARTS FOR KRONE® EASYCOLLECT 6000, 7500, 9000

Replacement parts produced by Kooima® Company to fit Krone®

KOOIMA #		DESCRIPTION	REPLACES OEM #
KR3522314 (LH)		• Guide	3522314
KR3522324 (RH)		• To fit Krone® Easycollect 6000, 7500 & 9000 series	3522324
\$15.30 ea.			

KR3529770 (LH)		• Adapter plate	3529770
KR3529780 (RH)		• To fit Krone® Easycollect 6000, 7500 & 9000 series	3529780
\$10.25 ea.			

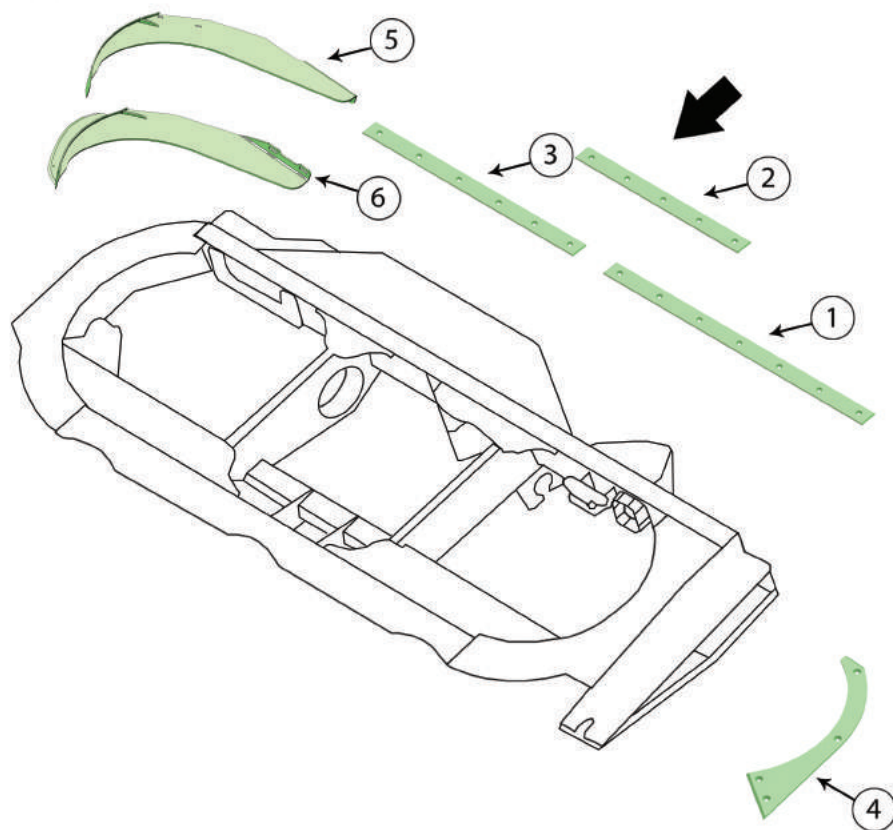

KOOIMA #		DESCRIPTION	REPLACES OEM #
KR3524002	①	• Rail wear strip	3524002
		• To fit Krone® Easycollect 6000, 7500 & 9000 series	
\$60.45 ea.			
KR3524072	②	• Rail wear strip	3524072
		• To fit Krone® Easycollect 6000, 7500 & 9000 series	
\$39.85 ea.			
KR3527962	③	• Rail wear strip	3527962
		• To fit Krone® Easycollect 6000, 7500 & 9000 series	
\$47.85 ea.			
KR3524012 (LH)	④	• Outside rail wear strip	3524012
KR3524022 (RH)		• To fit Krone® Easycollect 6000, 7500 & 9000 series	3524022
\$75.45 ea.			
KR3525785 (LH) (shown)	⑤	• Lower stripper plate	3525785
KR3525775 (RH)		• To fit Krone® Easycollect 6000, 7500 & 9000 series	3525775
\$150.75 ea.			
KR3525795 (LH) (shown)	⑥	• Upper stripper plate	3525795
KR3525805 (RH)		• To fit Krone® Easycollect 6000, 7500 & 9000 series	3525805
\$150.75 ea.			

TO ORDER CALL TOLL FREE 1-800-522-8874



KOOIMA® REPLACEMENT PARTS FOR KRONE® EASYCOLLECT 753, 903, 1053

Replacement parts produced by Kooima® Company to fit Krone®

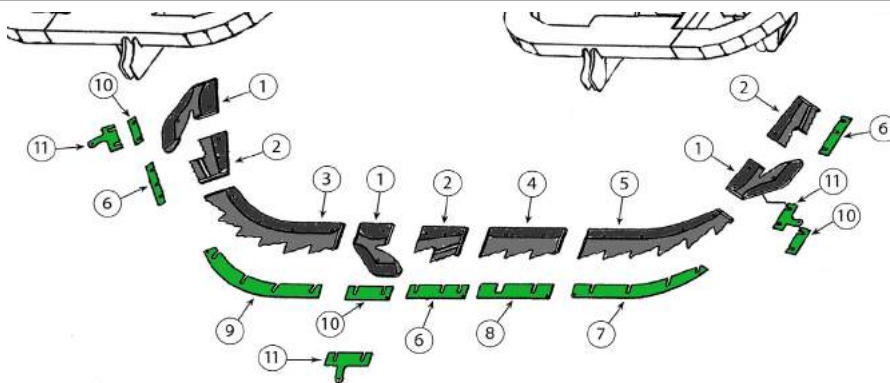

	KOOIMA #	PRICE	DESCRIPTION	
①	KR200936110 (LH) KR200936100 (RH)	\$100.00 ea.	• Side v knife • 3 required • 2.5 lbs.	Heat Treated/Tungsten Carbide
②	KR200936070 (LH) KR200936060 (RH)	\$65.00 ea.	• Side v knife stepped • 3 required • 1.89 lbs.	Heat Treated/Tungsten Carbide
③	KR200931310 (LH) KR200931300 (RH)	\$125.75 ea.	• Inside bow knife • 1 required • 5.34 lbs.	Heat Treated/Tungsten Carbide
④	KR200931231 (LH) KR200931221 (RH)	\$60.00 ea.	• Side ladder cutter • 1 required • 3.05 lbs.	Heat Treated/Tungsten Carbide
⑤	KR200931290 (LH) KR200931280 (RH)	\$125.75 ea.	• Outside bow knife • 1 required • 4.94 lbs.	Heat Treated/Tungsten Carbide
⑥	KR200936410 KR200936390	\$1.25 ea. \$1.25 ea.	• .5 mm shim • To fit Krone® Easycollect 753, 903 & 1053 series • .05 lbs. • 2 mm shim • To fit Krone® Easycollect 753, 903 & 1053 series • .15 lbs.	
⑦	KR200930540 KR200930420	\$1.25 ea. \$1.25 ea.	• .5 mm shim • To fit Krone® Easycollect 753, 903 & 1053 series • .1 lbs. • 2 mm shim • To fit Krone® Easycollect 753, 903 & 1053 series • .45 lbs.	
⑧	KR200930570 KR200930391	\$1.25 ea. \$1.25 ea.	• .5 mm shim • To fit Krone® Easycollect 753, 903 & 1053 series • .10 lbs. • 2 mm shim • To fit Krone® Easycollect 753, 903 & 1053 series • .35 lbs.	
⑨	KR200930590 KR200930430	\$1.25 ea. \$1.25 ea.	• .5 mm shim • To fit Krone® Easycollect 753, 903 & 1053 series • .1 lbs. • 2 mm shim • To fit Krone® Easycollect 753, 903 & 1053 series • .6 lbs.	
⑩	KR200936400	\$1.25 ea.	• .5 mm shim • To fit Krone® Easycollect 753, 903 & 1053 series • .05 lbs.	
⑪	KR200936380	\$1.25 ea.	• 2 mm shim • To fit Krone® Easycollect 753, 903 & 1053 series • .15 lbs.	

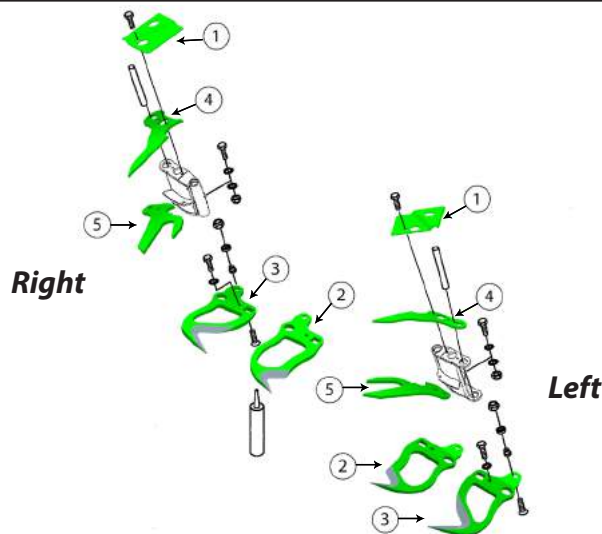

	KOOIMA #	PRICE	DESCRIPTION	
①	KR200903533 (LH) KR200903593 (RH)	\$4.00 ea.	• Cover plate • .7 lbs.	
②	KR200936450 (LH) KR200936480 (RH)	\$70.00 ea.	• Finger knife • To fit Krone® 753, 903 & 1053 corn heads • 2.8 lbs. • SN. 820001 and above will fit earlier models if changed to the large pin	
③	KR200936460 (LH) KR200936470 (RH)	\$70.00 ea.	• Finger knife • To fit Krone® 753, 903 & 1053 corn heads • 2.8 lbs. • SN. 820001 and above will fit earlier models if changed to the large pin	
④	KR200903522	\$7.75 ea.	• Top collector finger • SN.784901 & up; 2009 heads & newer • 753 & 903: 24 req./side • 1053: 28 req./side • 1.25 lbs.	Heat Treated
⑤	KR200924340	\$9.25 ea.	• Middle wrapping finger • SN.784901 & up; 2009 heads & newer • 753 & 903: 24 req./side • 1053: 28 req./side • 1.8 lbs.	Heat Treated

FREE FREIGHT ON RETAIL ORDERS OVER \$750.00!

KOOIMA® REPLACEMENT PARTS FOR KRONE® EASYCOLLECT 753, 903, 1053

Replacement parts produced by Kooima® Company to fit Krone®

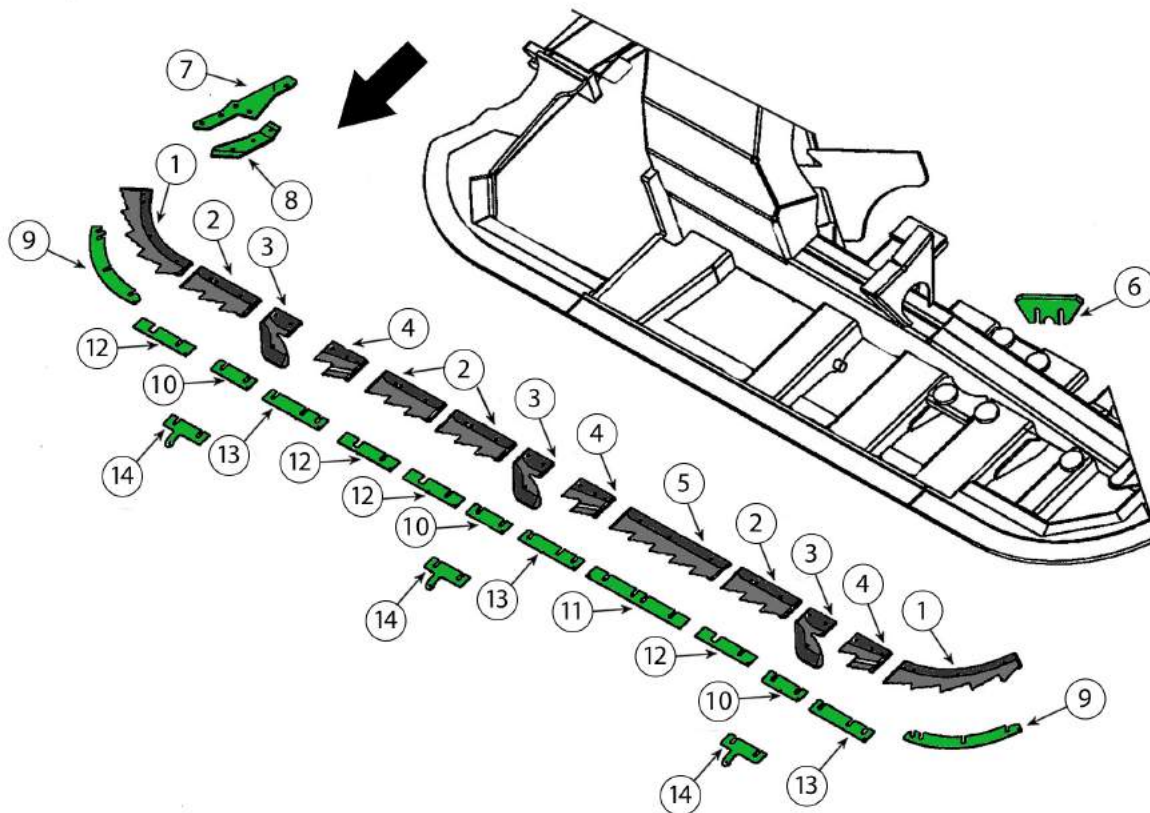

	<u>KOOIMA #</u>	<u>PRICE</u>	<u>DESCRIPTION</u>
①	KR200931270 (LH) KR200931260 (RH)	\$135.00 ea.	• Lateral bow knife • 4.18 lbs. Heat Treated/Tungsten Carbide
②	KR200931231 (LH) KR200931221 (RH)	\$60.00 ea.	• Side ladder cutter • 3.05 lbs. Heat Treated/Tungsten Carbide • 753: 2 required; 903: 4 required; 1053: 5 required
③	KR200936110 (LH) KR200936100 (RH)	\$100.00 ea.	• Side v knife • 2.5 lbs. Heat Treated/Tungsten Carbide • 753: 2 required; 903: 3 required; 1053: 4 required
④	KR200936070 (LH) KR200936060 (RH)	\$65.00 ea.	• Side v knife stepped • 1.89 lbs. Heat Treated/Tungsten Carbide • 753: 2 required; 903: 3 required; 1053: 4 required
⑤	KR200931250 (LH) KR200931240 (RH)	\$125.00 ea.	• Inner cutter knife • 5.31 lbs. Heat Treated/Tungsten Carbide • 1 required for all models
⑥	KR200931340	\$11.25 ea.	• Stripper knife • 753, 903 & 1053 corn heads SN. 784901 & above • 2 required for each side • 2.15 lbs. Heat Treated/Tungsten Carbide
⑦	KR200930471	\$7.25 ea.	• Blade plate • 1.95 lbs. • To fit Krone® 753, 903 & 1053 corn heads SN. 784901 & above
⑧	KR200915722 (LH) KR200915712 (RH)	\$20.30 ea.	• Guide disc • 1 lb. • To fit Krone® 753, 903 & 1053 corn heads SN. 784901 & above
⑨	KR200930580 KR200930380	\$1.25 ea. \$7.25 ea.	• .5 mm shim • To fit Krone® Easycollect 753, 903 & 1053 series • .1 lbs. • 2 mm shim • To fit Krone® Easycollect 753, 903 & 1053 series • .5 lbs.
⑩	KR200936400	\$1.25 ea.	• .5 mm shim • To fit Krone® Easycollect 753, 903 & 1053 series • .05 lbs.
⑪	KR200930550 KR200930410	\$1.25 ea. \$7.25 ea.	• .5 mm shim • To fit Krone® Easycollect 753, 903 & 1053 series • .15 lbs. • 2 mm shim • To fit Krone® Easycollect 753, 903 & 1053 series • .5 lbs.
⑫	KR200930570 KR200930391	\$1.25 ea. \$1.25 ea.	• .5 mm shim • To fit Krone® Easycollect 753, 903 & 1053 series • .10 lbs. • 2 mm shim • To fit Krone® Easycollect 753, 903 & 1053 series • .35 lbs.
⑬	KR200936410 KR200936390	\$1.25 ea. \$1.25 ea.	• .5 mm shim • To fit Krone® Easycollect 753, 903 & 1053 series • .05 lbs. • 2 mm shim • To fit Krone® Easycollect 753, 903 & 1053 series • .15 lbs.
⑭	KR200936380	\$1.25 ea.	• 2 mm shim • To fit Krone® Easycollect 753, 903 & 1053 series • .15 lbs.



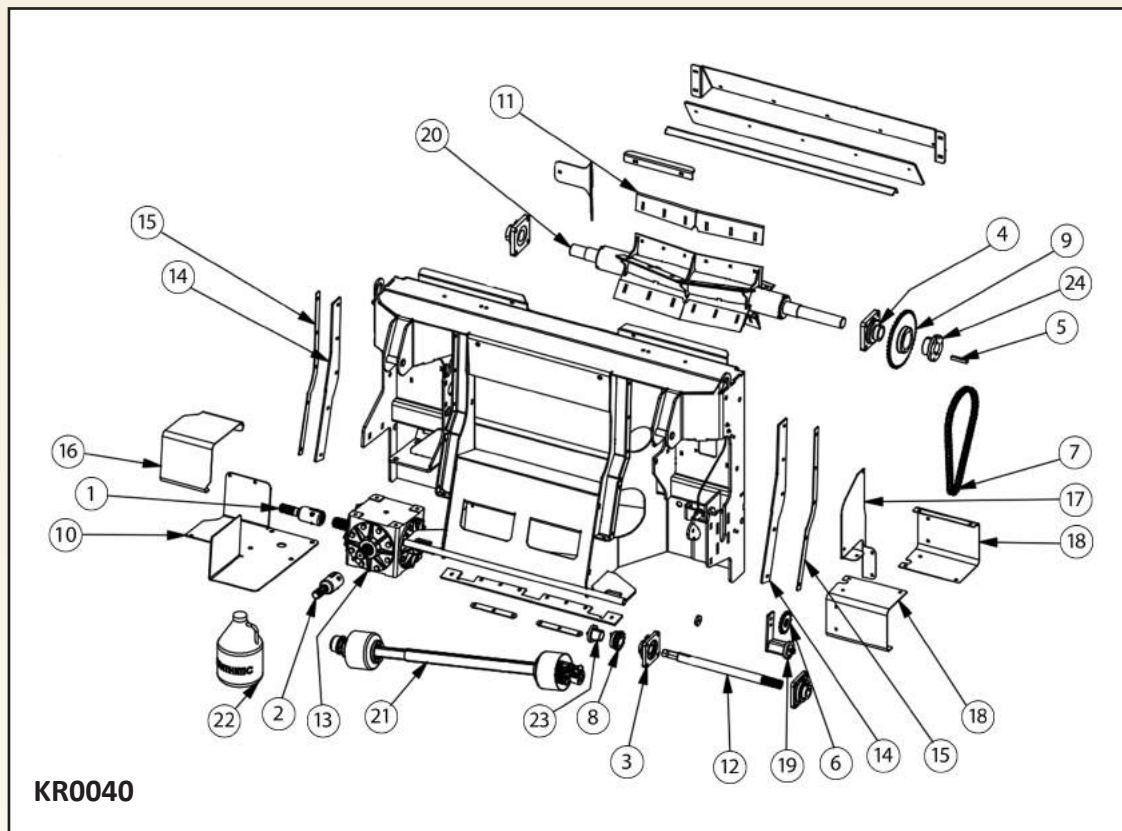

KR0040

KOOIMA #	PRICE	DESCRIPTION
① K1172821	\$180.75 ea.	• Clamping spline adapter • 1.75 20 to 1.38 21 spline • 5.8 lbs.
② K33201476	\$185.00 ea.	• Clamping spline adapter • 1.75 20 to 1.38 6 spline • 5.8 lbs.
③ 15-4BOLT-LC	\$75.45 ea.	• Bearing Ø 1.50; 4-bolt flange, lock collar • 4.75 lbs.
④ 20-4BOLT-LC	\$115.00 ea.	• Ball bearing, 4-bolt flange, lock collar, 2" shaft • 7.15 lbs. • 2 required
⑤ 50KEY48	\$3.25 ea.	• Key square 1/2" x 3" • .25 lbs.
⑥ 60BB15X0.5	\$30.35 ea.	• 15 tooth idler sprocket • 1.12 lbs.
⑦ 60H-62	\$50.35 ea.	• #60 heavy roller chain, 62 pitches • 4.8 lbs.
⑧ 60P13H	\$50.35 ea.	• Squeeze style sprocket, #60-13 tooth hardened • 1.35 lbs.
⑨ 60SF42	\$70.45 ea.	• #60 sprocket, 42 tooth, QD hub • 10.5 lbs.
⑩ FH002477KR	\$45.00 ea.	• Gearbox bottom shield • 25.6 lbs.
⑪ FH002767	\$30.35 ea.	• Both on tooth • 5.8 lbs. • 5 required • Bolt kit: FH002767BK, \$2.65 ea.
⑫ FH002775	\$110.75 ea.	• Bottom shaft, 1-1/8 hex to 1.38-21 spline • 10.4 lbs.
⑬ FH003544	\$1,500.00 ea.	• Curtiss 615MA Gearbox • 1:1 ratio • 1.75-20 spline • 170 lbs. 🚚
⑭ FH003563	\$30.35 ea.	• Belted rubber sealing flap • 1 lb. • 2 required
⑮ FH003574	\$15.30 ea.	• Side support strap • 1.5 lbs. • 2 required
⑯ FH003579	\$25.30 ea.	• Gearbox top cover • 4.75 lbs.
⑰ FH003580	\$21.30 ea.	• RH Chain and PTO Guard • 2.7 lbs.
⑱ FH003582	\$21.30 ea.	• RH PTO Shield • 6 lbs. • 2 required • 3.1 lbs. ea.
⑲ FH003613	\$80.45 ea.	• Rosta tensioner, SE-27 • 5.25 lbs.
⑳ FH5000973	\$650.80 ea.	• Flap Wheel • 128 lbs. 🚚
㉑ K00492PTO	\$490.00 ea.	• 1-3/4"20 spline to 1-1/8" hex drive line • 42 lbs.
㉒ 75W-90PS	\$13.00 ea.	• 1 quart oil • 2 lbs. • 4 quarts needed
㉓ P11.5	\$35.35 ea.	• P1 bushing, for 1-1/2 shaft • 1 lb.
㉔ SFX2.0	\$25.30 ea.	• QD bushing, 2.00" shaft • 4 lbs.

HAY PICK-UP TEETH

Kooima® hay pick-up teeth are manufactured from hi-tensile drawn spring wire for uniform strength and durability.



- Pick-up tooth
- To fit most New Holland® forage harvester hay heads
- Replaces OEM # 86632007BDS

Order # **K131673** (.5 lbs.)

\$1⁹⁰ ea.



- Pick-up tooth
- To fit all John Deere® 5 1/2 ft. forage heads
- Replaces OEM #268SE

Order # **K268SE** (.45 lbs.)

\$2⁰⁵ ea. Bolt Kit: **K268SEBK**: \$4.25 ea.



- Pick-up tooth
- To fit all John Deere® 630, 645, 630A, 640A, 645A, 630B, 640B, 645B, 630C, 640C & 645C forage harvester hay heads
- Replaces OEM #CC25176

Order # **K25176** (.45 lbs.)

\$3⁹⁵ ea. Bolt Kit: **K25176BK**: \$2.75 ea.



- HP Pick-up tooth
- To fit all John Deere® 630, 645, 630A, 640A, 645A, 630B, 640B, 645B, 630C, 640C & 645C forage harvester hay heads
- Replaces OEM #CC25176

Order # **K25176HP** (.45 lbs.)

\$5³⁵ ea. Bolt Kit: **K25176BK**: \$2.75 ea.



- Pick-up tooth - 7.40" long
- To fit New Holland® 270FP, 280FP, 290FP & 380FP hay heads
- Replaces OEM # 84390221

Order # **K84390221**

\$8⁷⁰ ea.



- Pick-up tooth
- To fit all John Deere® 7 1/2 ft. forage harvester hay heads after SN. 550001
- Replaces OEM #E74678

Order # **K74678** (.5 lbs.)

\$2²⁰ ea. Bolt Kit: **K74678BK**: \$3.50ea.



- Pick-up tooth
- To fit all Claas® forage harvester hay heads

Order # **K2126290** (.6 lbs.)

\$3⁹⁵ ea.



- HP Pick-up tooth
- To fit all Claas® forage harvester hay heads

Order # **K2126290HP** (.8 lbs.)

\$4⁹⁵ ea.

HP hay pick-up teeth are "shot peened," giving them added strength!



Your #1 Source For Used Parts



**New Holland®
Self-Propelled
Forage Harvester**

PARTS

1-877-427-6950

www.iowacuttersupply.com

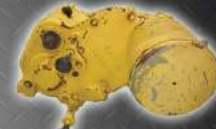

Claas®

John Deere®

Kemper™

New Holland®

Krone®

Iowa Cutter Supply

1 1/2 miles East on Hwy 18
2642 Rock Ridge Road
Rock Valley, IA 51247

If you have a cutter to sell:
Email pictures and a description to
sales@iowacuttersupply.com
or
Call 1-877-427-6950 and ask for Ivan

TO ORDER CALL TOLL FREE 1-800-522-8874

**KOOIMA®
COMPANY**

179

Kooima® Replacement Parts To Fit NEW HOLLAND®

KOOIMA® REPLACEMENT PARTS TO FIT NEW HOLLAND® FR FORAGE HARVESTERS

New Holland® is a registered trademark of CNH Industrial America, LLC, which does not manufacture, distribute or endorse these parts.

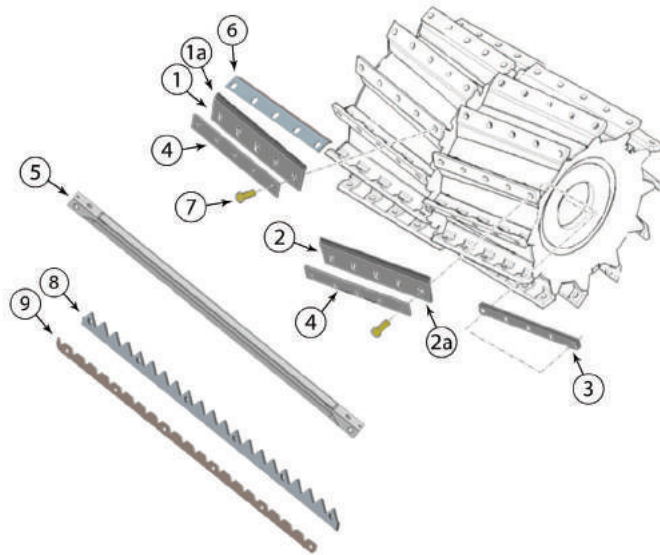









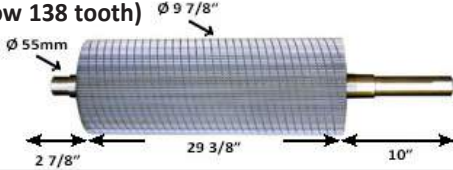



Replacement parts produced by Kooima® Company to fit New Holland®

KOOIMA #	DESCRIPTION	REPLACES OEM #
K84450404 (Corn) \$45.25 ea.	① • Left hand corn knife • To fit all FR series harvesters • 10 required with 20-knife cylinder, 12 required with 24-knife cylinder • 4.8 lbs.	84450404 Heat Treated Tungsten Carbide
K84450405 (Corn) \$45.25 ea.	② • Right hand corn knife • To fit all FR series harvesters • 10 required with 20-knife cylinder, 12 required with 24-knife cylinder • 4.8 lbs.	84450405 Heat Treated Tungsten Carbide
K84450406 (Grass) \$45.25 ea.	①a • Left hand grass knife • To fit all FR series harvesters • 10 required with 20-knife cylinder, 12 required with 24-knife cylinder • 4.7 lbs.	84450406 Heat Treated Tungsten Carbide
K84450407 (Grass) \$45.25 ea.	②a • Right hand grass knife • To fit all FR series harvesters • 10 required with 20-knife cylinder, 12 required with 24-knife cylinder • 4.7 lbs.	84450407 Heat Treated Tungsten Carbide
K84458371 \$24.30 ea.	③ • Nut Bar • To fit all FR series harvesters • 3.2 lbs.	84458371 Heat Treated
K84450403 \$18.00 ea.	④ • Top strap • To fit all FR series harvesters • 2.1 lbs.	87720029/84450403 Tungsten Carbide
K87325326HP \$945.80 ea.	⑤ • High performance shearbar • 33.4 lbs. • For use in hay and corn • To fit all FR series harvesters	87325326 Tungsten Carbide
K87368863 \$17.80 ea.	⑥ • Knife baffle - protects your cutter drum brackets • Will NOT fit FR 3-digit machines • Will need longer bolts when using this baffle • 1.8 lbs.	87368863 Abrasion Resistant
K87517126 \$5.25 ea.	⑦ • Knife bolt • To fit all FR series harvesters • .3 lbs.	87517126 Tungsten Carbide
K84450505 \$7.00 ea.	⑦a • Knife bolt • Extended length to be used with cutter drum plates • To fit all FR series harvesters • .35 lbs.	84450505 / 87517126
K84339903 \$28.80 ea.	⑧ • Upper front feed roll teeth • 10 required • 1.8 lbs. Stainless Steel • To fit all FR series harvesters except FR machines (450-480-500-550-600-650-700-780-850)	84099775 / 84339903
K47373020 \$28.80 ea.	⑧a • Upper front feed roll teeth • 10 required • .32 lbs. • To fit NH FR "3 digit" harvesters	47373020 Stainless Steel
K84339903BK \$130.75 ea.	⑧b • Bolt kit to fit K84339903 & K47373020 tooth • 1 kit required • M10 x 45mm bolt • Above serial number D800 • Needed when using 84603422 Lath • 5.8 lbs.	84364042 / 84408059
K84099775BK \$135.75 ea.	⑧c • Bolt kit to fit K84339903 & K47373020 tooth • 1 kit required • M10 x 25mm bolt • Below serial number D800 • Needed when NO Lath is installed • 4.4 lbs.	84056909 / 84099499
K84389960 \$22.05 ea.	⑨ • Lower front feed roll teeth • 12 required • 1.3 lbs. Stainless Steel • To fit all FR series with replaceable teeth except (450-480-500-550-600-650-700-780-850)	47690733 / 84389960
K47744044 \$19.55 ea.	⑨a • Lower front feed roll teeth • 12 required • 1.3 lbs. • To fit all FR 3 digit series (450, 480, 500, 550, 600, 650, 700, 780 & 850)	Stainless Steel
K84389960BK \$75.45 ea.	⑨b • Bolt kit for K84389960 & K47744044 tooth • 2.6 lbs. • 1 kit has 72 bolts and nuts	84390794 / 84390793

KOOIMA® REPLACEMENT PARTS TO FIT NEW HOLLAND® FR FORAGE HARVESTERS

Replacement parts produced by Kooima® Company to fit New Holland®

KOOIMA #		DESCRIPTION	REPLACES OEM #
K87383779 \$115.00 ea.		<ul style="list-style-type: none"> Sharpening stone To fit all FR series harvesters • 5.5 lbs. 	87383779
FR87348753F (Fast 124 tooth) FR87348753S (Slow 138 tooth) \$2,240.00 ea.		<ul style="list-style-type: none"> Kernel processor roll To fit all New Holland® FR series harvesters Get the real value out of your processor with new Chevron Series Fiber Tech High Capacity Rolls It can increase chopper forward speed by as much as 12 % over standard rolls! 	Heat Treated 236 lbs. Chromed plated roll
K2211EC3 \$110.75 ea.		<ul style="list-style-type: none"> Drive side processor bearing To fit all FR series harvesters 2 required • 1.85 lbs. 	
K2211TN9 \$145.00 ea.		<ul style="list-style-type: none"> Off side processor bearing To fit all FR series harvesters 2 required • 1.75 lbs. 	
K87486863 \$475.80 ea.		<ul style="list-style-type: none"> Grass chute To fit serial #D620 and after 41.1 lbs. 	87486863 Abrasion Resistant
K87476501 \$18.00 ea.		<ul style="list-style-type: none"> Rubber seal for K87486863 To fit all FR series harvesters .7 lbs. 	87476501
K87474515 \$11.25 ea.		<ul style="list-style-type: none"> Grass chute fixing plate To fit serial #D620 and after • .65 lbs. 	87474515
K84194771 \$590.80 ea.		<ul style="list-style-type: none"> Blower door To fit all FR series harvesters 64.4 lbs. 	84194771 Abrasion Resistant
K84136093 \$135.75 ea.		<ul style="list-style-type: none"> Cutter door To fit all FR series harvesters after SN. D632 22.4 lbs. 	84136093 Abrasion Resistant
K84136093BK \$11.25 ea.		<ul style="list-style-type: none"> Hardware kit for K84136093 To fit all FR series harvesters .3 lbs. 	
K84397877 \$105.75 ea.		<ul style="list-style-type: none"> Blower paddle • 8.3 lbs. To fit all FR series harvesters • Can also be used on all older blowers 6 required per blower • Ideal for grass 	
K87720026 \$22.00 ea.		<ul style="list-style-type: none"> Inner blower paddle • Ideal for corn To fit all FR series harvesters after SN. D640 6 pieces required per blower • Koyma Klad® coating Added wider tungsten for more adjustment • 1.8 lbs. 	877200276 Tungsten Carbide
K87720027 \$22.00 ea.		<ul style="list-style-type: none"> Outside blower paddle • Ideal for corn To fit all FR series harvesters after SN. D640 12 pieces required per blower • Koyma Klad® coating Added wider tungsten for more adjustment • 1.9 lbs. 	877200277 Tungsten Carbide
K87720027BK \$90.45 ea.		<ul style="list-style-type: none"> Paddle hardware kit To fit all FR series harvesters One kit required • 7.3 lbs. 	

TO ORDER CALL TOLL FREE 1-800-522-8874



KOOIMA® REPLACEMENT PARTS TO FIT NEW HOLLAND® FR FORAGE HARVESTERS

Replacement parts produced by Kooima® Company to fit New Holland®

KOOIMA #
K84386708
\$1,390.00 ea.



DESCRIPTION
• Upper rear feed roll
• To fit all FR series harvesters

REPLACES OEM #
84386708/87343404

K47362200
\$1,250.00 ea.



• Lower rear smooth roll
• To fit FR series, D724 and above w/ campaign H33
• 56 lbs.

4736220/84253846

K84526146
\$550.80 ea.



• Smooth roll cleaner
• To fit FR series
• 18 lbs.

84526146/87340658/87532939
Tungsten Carbide

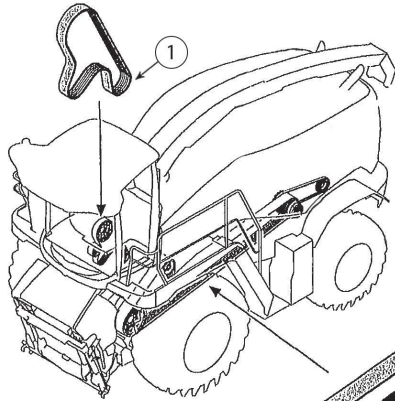

KOOIMA #
K84449861
\$195.00 ea.
K84458482
\$600.00 ea.
K84457069
\$800.80 ea.



DESCRIPTION
• Processor belt
• To fit all FR series harvesters • 6 lbs.
• Main belt (7 groove) • 31.6 lbs.
• To fit FR9040, FR9050, FR9060 & FR450-600 machines
• Main belt (9 groove) • 42 lbs.
• To fit FR9080, FR9090 & FR650-850 machines

REPLACES OEM #
84449861
84458482
84457069

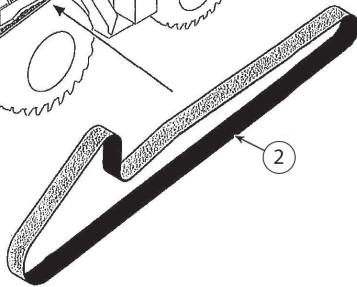

High Quality Silage Covers

We also carry 6 mil and 8 mil reinforced string tarps, for more information on these go to the front inside cover.



Detail of reinforced string tarps

Prices are subject to change.

Standard Silage Tarps White/Black - 5.0 mil (A5WB1)

Part #	Price	W X L	Weight
K57442	\$108.00	24 X 100	69 lbs.
K57443	\$144.00	32 X 100	90 lbs.
K57628	\$216.00	32 X 150	133 lbs.
K46534	\$180.00	40 X 100	110 lbs.
K57574	\$270.00	40 X 150	163 lbs.
K57575	\$360.00	40 X 200	216 lbs.
K50158	\$225.00	50 X 100	138 lbs.
K50159	\$337.50	50 X 150	203 lbs.
K54235	\$450.00	50 X 200	299 lbs.
K57576	\$270.00	60 X 100	161 lbs.
K53942	\$405.00	60 X 150	255 lbs.
K57577	\$540.00	60 X 200	346 lbs.
K64369	\$2,100.60	60 X 1000	1,557 lbs.
K69881	\$540.00	80 X 150	325 lbs.
K69880	\$720.00	80 X 200	455 lbs.
K70463	\$900.00	80 X 250	561 lbs.
K77059	\$2,800.80	80 X 1000	1,999 lbs.

* Free shipping on Silage Covers if combined with \$750 in Kooima® parts on phone and internet orders

KOOIMA® REPLACEMENT PARTS TO FIT NEW HOLLAND® FR FORAGE HARVESTERS

Replacement parts produced by Kooima® Company to fit New Holland®

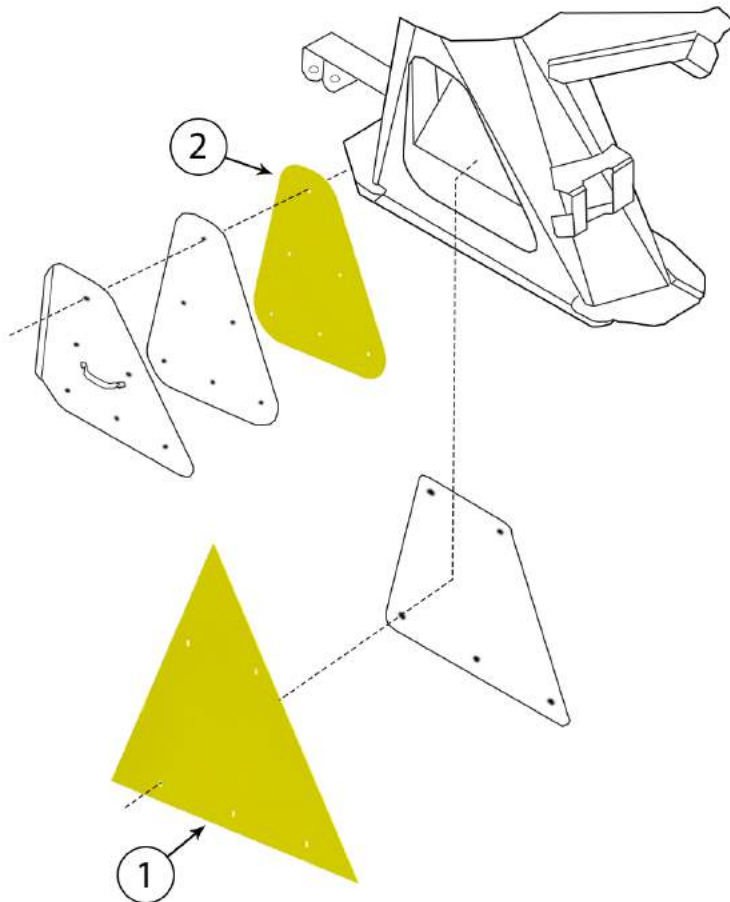

KOOIMA #

K87567620

\$75.45 ea.

①

DESCRIPTION

- Transition chute liner
- To fit all FR series harvesters • 17.2 lbs

REPLACES OEM #

87567620/87399325

Abrasion Resistant

K87567620BK

\$9.75 ea.

①a

- Hardware kit for K87567620
- To fit all FR series harvesters • .2 lbs

K87515847

\$20.30 ea.

②

- Transition chute liner
- To fit all FR series harvesters • 4.7 lbs.

87515847

K87515847BK

\$9.75 ea.

②a

- Hardware kit for K87515847
- To fit all FR series harvesters • .25 lbs.

K84196734



- Transition chute liner
- To fit all FR series harvesters SN#887 and below
- 62 lbs.

84196734

Abrasion Resistant

\$650.80 ea.

K84196734BK



- Hardware kit for K4196734
- To fit all FR series harvesters
- .35 lbs.

\$20.30 ea.

Order online at WWW.KOOIMA.COM and receive **FREE FREIGHT** to your door!

KOOIMA
COMPANY



KOOIMA® REPLACEMENT PARTS TO FIT NEW HOLLAND® FR FORAGE HARVESTERS

Replacement parts produced by Kooima® Company to fit New Holland®

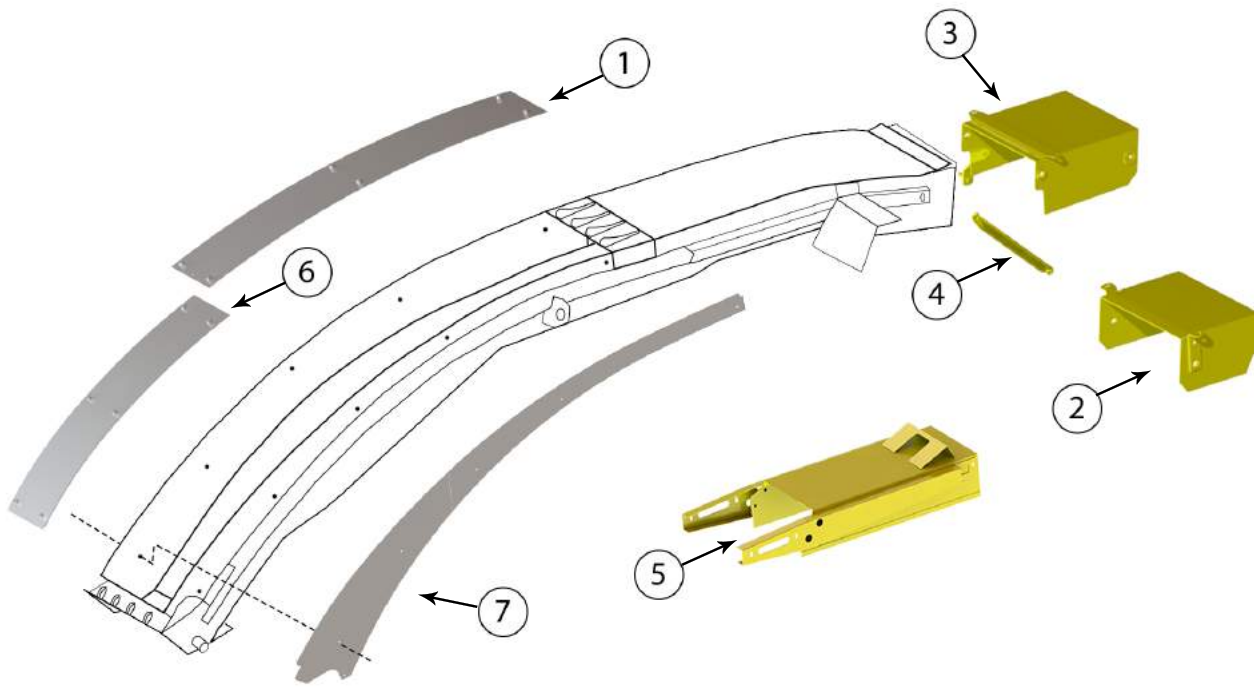

KOOIMA #	DESCRIPTION	REPLACES OEM #
K84246330 \$95.00 ea.	① • Spout top liner • 20.2 lbs	84246330
K84246330BK \$9.25 ea.	①a • Hardware kit for K84246330 • To fit harvesters after SN. D734 • .3 lbs	
K84122208 \$60.45 ea.	② • Grass outer deflector • To fit harvesters after SN. D620 • 13 lbs.	84122208/84452928 Abrasion Resistant
K84122042 \$80.00 ea.	② • Corn outer deflector • To fit harvesters after SN. D620 • 15.4 lbs.	84122042/84453037 Abrasion Resistant
K84122042BK \$55.35 ea.	②a • Outer spout deflector hardware kit • To fit all FR series harvesters • .65 lbs.	
K84122206 \$120.00 ea.	③ • Grass inner deflector • To fit harvesters after SN. D620 • 19.6 lbs.	84122206/84452921 Abrasion Resistant
K84122034BK \$13.80 ea.	③a • Inner spout deflector hardware kit • To fit all FR series harvesters • .2 lbs.	
K84043464 \$34.00 ea.	④ • Spout deflector brace • To fit New Holland® FR series • 1.6 lbs.	84043464
K87694972 \$420.00 ea.	⑤ • 3' spout extension • To fit harvesters after SN. D500 • 34.7 lbs.	87694972/87516797/84458221 Abrasion Resistant
K87694972BK \$35.00 ea.	⑤a • Hardware kit for K87694972 • To fit harvesters after SN. D500 • .55 lbs.	
K87693538 \$225.75 ea.	⑥ • Spout bottom liner • 28 lbs. • To fit harvesters after SN. D574	87693538/84462153/87629935 Abrasion Resistant
K87693538BK \$9.25 ea.	⑥a • Hardware kit for K87693538 • .3 lbs.	
K87629322 \$66.00 ea.	⑦ • Spout side liner • To fit FR series harvesters after SN. D550 • 24 lbs.	87629322/84462031 Abrasion Resistant
K87629322BK \$8.25 ea.	⑦a • Hardware kit for K87629322 • To fit all FR series harvesters • .2 lbs.	











KOOIMA® REPLACEMENT PARTS TO FIT NEW HOLLAND® FORAGE HARVESTERS

New Holland® is a registered trademark of CNH Industrial America, LLC, which does not manufacture, distribute or endorse these parts.

Replacement parts produced by Kooima® Company to fit New Holland®

Kooima® knives are:











- Manufactured to exacting specifications
- Heat treated for edge hardness and durability
- Made in the USA
- Made of high carbon steel
- Tungsten carbide edged for maximum wear

<u>KOOIMA #</u>	<u>DESCRIPTION</u>	<u>REPLACES OEM #</u>
K216973 \$73.00 ea.	 • Knife, double edged • To fit S717 SN. 128546 & up, & 718 to SN. 308390 • 6, 9 or 12 required • 5.8 lbs.	216973 Heat Treated Tungsten Carbide
K216281 \$79.00 ea.	 • Knife, single edged • To fit New Holland® 770 • 6 or 12 required • 5.4 lbs.	216281 Heat Treated Tungsten Carbide
K237519 \$125.75 ea.	 • Shearbar • To fit New Holland® 717, S717, 718 and 770 • 4.9 lbs.	449017/237519 Heat Treated Tungsten Carbide
K638297 \$77.95 ea.	 • Knife, double edged • To fit New Holland® 782 • 12 required • 7 lbs.	638297 Heat Treated Tungsten Carbide
K784651 \$57.85 ea.	 • Knife, single edged • To fit New Holland® 790 • 12 required • 6.5 lbs.	784651B/784651 Heat Treated Tungsten Carbide
K9610799 \$130.75 ea.	 • Shearbar • To fit New Holland® 782 and 790 • 6.7 lbs.	9610799 Heat Treated Tungsten Carbide
K221755 \$75.00 ea.	 • Knife, single edged • To fit New Holland® 880 and 1880 • 6 or 9 required • 6.5 lbs.	221755 Heat Treated Tungsten Carbide
K243725 \$75.00 ea.	 • Knife, single edged • 6.5 lbs. • To fit New Holland® 890, 895, 1890 to SN. 258122 and 1895 to SN. 344989 • 6, 8 or 12 required	243725 Heat Treated Tungsten Carbide
K635411 \$95.00 ea.	 • Knife, double edged • To fit New Holland® 892 • 8 or 12 required • 8 lbs.	635411 Heat Treated Tungsten Carbide
K237521 \$130.00 ea.	 • Shearbar • To fit New Holland® 818, 880, 890, 892, 895, 1890 and 1895 • 3.6 lbs.	237521 Heat Treated Tungsten Carbide













KOOIMA® REPLACEMENT PARTS TO FIT NEW HOLLAND® FORAGE HARVESTERS

Replacement parts produced by Kooima® Company to fit New Holland®

KOOIMA #	DESCRIPTION	REPLACES OEM #
K676997 \$71.60 ea.	 • Knife, single edged • To fit New Holland® 900 • To fit New Holland® FP230 • 12 required • 8 lbs.	676997 Heat Treated Tungsten Carbide
K86641950 \$15.05 ea.	 • Knife baffle • To fit New Holland® 900 • To fit New Holland® FP230 • 12 required • 2.95 lbs.	86641950
K9617519 \$140.75 ea.	 • Shearbar • To fit New Holland® 900 to SN. 751185 • 18.4 lbs.	9617519 Heat Treated Tungsten Carbide
K9611168 \$175.75 ea.	 • Shearbar • To fit New Holland® 900 SN. 751186 and up • 16.6 lbs.	9611168 Heat Treated Tungsten Carbide
K86632788 \$280.75 ea.	 • Shearbar • To fit New Holland® FP230 • 15.8 lbs.	86632788 Heat Treated Tungsten Carbide
K86624446 \$77.95 ea.	 • Knife • To fit New Holland® FP240 & FHX300 • Also fits Case IH® FHX 300 • 12 required • 8.5 lbs.	86624446 Heat Treated Tungsten Carbide
K86632157 \$310.80 ea.	 • Shearbar • To fit New Holland® FP240 & FHX300 • Also fits Case IH® FHX 300 • 18.5 lbs.	86632157 Heat Treated Tungsten Carbide
K770254 \$120.75 ea.	 • Knife, double edged • To fit New Holland® 1600 and 1900 • 12 required • 9.2 lbs.	770254 Heat Treated Tungsten Carbide
K796287HP \$625.80 ea.	 • Hi-performance shearbar • To fit New Holland® 1900 • 22.8 lbs.	86607735 Heat Treated Tungsten Carbide
K642472 \$35.00 ea.	 • Knife baffle • To fit all 1900, 1905 & 1915 series harvesters • 12 required • 3.1 lbs.	86503030 642472
K9615439 \$102.00 ea.	 • Knife, double edged • To fit New Holland® 1905 & 1915 • 12 required • 10.8 lbs.	9615439 Heat Treated Tungsten Carbide
K9861382HP \$625.80 ea.	 • Hi-performance shearbar • To fit New Holland® 1905 & 1915 • 26.5 lbs. • Out-performs all other shearbars	86607734/9861382 Heat Treated Tungsten Carbide
K9616033 \$157.00 ea.	 • Knife, double edged • To fit all New Holland® 2115 • To fit New Holland® FX series grass knives • 8 or 12 required • 12.3 lbs.	89819423 9616033 Heat Treated Tungsten Carbide
K679439 \$40.00 ea.	 • Knife baffle • To fit all 2100, 2115 & FX harvesters • 8 or 12 required • 3.6 lbs.	86503031 679439

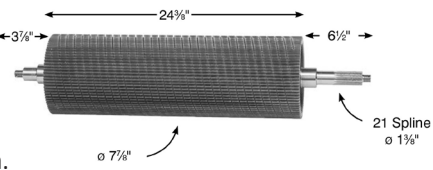
KOOIMA® REPLACEMENT PARTS TO FIT NEW HOLLAND® FORAGE HARVESTERS

Replacement parts produced by Kooima® Company to fit New Holland®

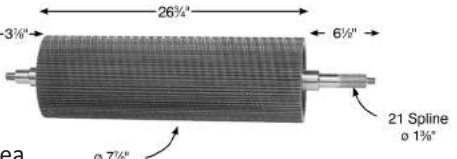
KOOIMA #	DESCRIPTION	REPLACES OEM #
K84023281  \$122.00 ea.	<ul style="list-style-type: none"> • Knife, double edged • To fit New Holland® FX series corn knives • To fit New Holland® 2115 series harvesters • 8 or 12 required • 11.9 lbs. 	84023281 Heat Treated Tungsten Carbide
K84454375  \$11.00 ea.	<ul style="list-style-type: none"> • Top strap • To fit New Holland® FX series harvesters • Replaces washer • 3 required per knife • .8 lbs. 	84454375 Heat Treated
K9621289HP  \$595.80 ea.	<ul style="list-style-type: none"> • Hi-performance shearbar • To fit New Holland® 2100 • 26.1 lbs. • Out-performs all other shearbars 	86607736/9621289 Tungsten Carbide
K9861383HP  \$640.00 ea.	<ul style="list-style-type: none"> • Hi-performance shearbar • To fit New Holland® 2115 and FX series • For use in hay or corn • 29 lbs. • Out-performs all other shearbars 	84062351/9861383 Heat Treated Tungsten Carbide
K58125 K58150 K916125 \$1.60 ea.	 <ul style="list-style-type: none"> • Knife bolt, 5/8" x 1 1/4" NF, grade 8 • .15 lbs. • Knife bolt, 5/8" x 1 1/2" NF, grade 8 • .2 lbs. • Knife bolt, 9/16" x 1 1/4" NF, grade 8 • .15 lbs. 	
K64053  \$1.35 ea.	<ul style="list-style-type: none"> • Knife bolt washer • .05 lbs. • To fit New Holland® 782, 790, 892, 900, 1915 and FX series 2115 	86528652/64053
K9619931 \$29.00 ea.	 <ul style="list-style-type: none"> • Sharpening stone, 1 1/2" dia. • To fit New Holland® 782, 790, 892 1880 and 1900 • 1 lb. 	9619931
K9619871 \$39.00 ea.	 <ul style="list-style-type: none"> • Sharpening stone, 2" dia. • 1.6 lbs. • To fit New Holland® 790, 900, 1900 and 2100 	9619871
K9805207  \$67.95 ea.	<ul style="list-style-type: none"> • Sharpening stone, 3" dia. • 3.5 lbs. • To fit New Holland® 1900, 1905, 2115, FP230, FP240 and FX series • Also fits Case IH® FHX 300 	9805207
K230DC  \$1,275.00 ea.	<ul style="list-style-type: none"> • Processor roll • 140 lbs.  • To fit New Holland® 900 & FP230 factory processors • 100 tooth • Dual cut for better processing • 2 required 	
K48548  \$23.80 ea.	<ul style="list-style-type: none"> • Bearings • To fit New Holland® 900, FP230 & FP240 factory processors • 8 required 	
K48510  \$12.75 ea.	<ul style="list-style-type: none"> • Bearing race • To fit New Holland® 900, FP230 & FP240 factory processors • 8 required 	
K240DC  \$1,290.00 ea.	<ul style="list-style-type: none"> • Processor roll • To fit New Holland® FP240 and Case IH® FHX300 factory processors • 100 tooth • Dual cut for better processing • 2 required 	

TO ORDER CALL TOLL FREE 1-800-522-8874















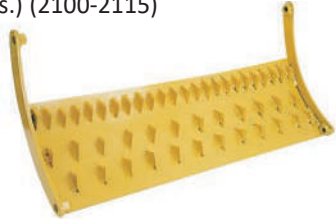

KOOIMA® REPLACEMENT PARTS TO FIT NEW HOLLAND® FORAGE HARVESTERS

Replacement parts produced by Kooima® Company to fit New Holland®

KOOIMA #	DESCRIPTION	REPLACES OEM #
K790FR \$370.00 ea.	 • Feed roll top back • To fit New Holland® 782 & 790 • More aggressive heavier tooth • 28 lbs.	686539
K764785 \$365.00 ea.	 • Smooth roll • To fit New Holland® 782 & 790 • 28 lbs.	764785
K701316 \$99.95 ea.	 • Smooth Roll Scraper • To fit New Holland® 782 & 790 • 5.2 lbs.	701316
K80700464 \$365.00 ea.	 • Lower front feed roll • To fit New Holland® 782 & 790 • 40 lbs.	80700464
K892FR \$450.80 ea.	 • Feed roll top back • To fit New Holland® 890 & 892 • More aggressive heavier tooth • 39.67 lbs.	603917
K715964 \$425.00 ea.	 • Smooth roll • To fit New Holland® 890 & 892 • 32.4 lbs.	715964
K227794 \$160.00 ea.	 • Smooth Roll Scraper • To fit New Holland® 890 & 892 • 5 lbs.	227794
K706646 \$405.80 ea.	 • Lower front feed roll - complete with drive sprocket • To fit New Holland® 890 & 892 • 49 lbs.	706646
K230FR \$470.00 ea.	 • Feed roll top back • To fit New Holland® 900 & FP230 • 39 lbs. • Heavier tooth helps eliminate any feeding issues	639338
K639349 \$410.00 ea.	 • Smooth roll • To fit New Holland® 900 & FP230 • 34 lbs.	639349
K642371 \$170.00 ea.	 • Smooth Roll Scraper • To fit New Holland® 900 & FP230 • 13.1 lbs.	642371
K676587 \$475.00 ea.	 • Lower front feed roll • To fit New Holland® 900 • 50 lbs. • Non metal detector roll	676587/86635470/ 47504254/641630
K240FR \$495.80 ea.	 • Feed roll top back • To fit New Holland® FP240 & FHX300 Case IH® • Heavier tooth helps eliminate any feeding issues • 43 lbs.	86635935/86512636
K86512516 \$360.00 ea.	 • Smooth roll • To fit New Holland® FP240 • 37.1 lbs.	86512516
K86635936 \$155.00 ea.	 • Smooth Roll Scraper • To fit New Holland® FP240 • 13.8 lbs.	86635936/86512872
K1900FR \$910.00 ea.	 • Upper rear feed roll (non stainless steel) • To fit New Holland® 1900, 1905 & 1915	856197

KOOIMA® REPLACEMENT PARTS TO FIT NEW HOLLAND® FORAGE HARVESTERS

Replacement parts produced by Kooima® Company to fit New Holland®













KOOIMA #	DESCRIPTION	REPLACES OEM #
K238321 \$38.35 ea.	 • Fan paddle • 3 required • 6.2 lbs. • To fit 890 & 892 harvesters • K857758BK , hardware kit: 1 kit/paddle, \$19.80 ea., 1 lb.	238321 Abrasion Resistant
K857758 \$38.35 ea.	 • Fan paddle • 3 required • 5 lbs. • To fit 782 & 790 harvesters • K857758BK , hardware kit: 1 kit/paddle, \$19.80 ea., 1 lb.	857758 Abrasion Resistant
K9601644 \$38.35 ea.	 • Fan paddle • 3 required • 5.5 lbs. • To fit 900 harvesters • K9601644BK , hardware kit: 1 kit/paddle, \$18.30 ea., .93 lbs.	9610638 / 9601644 Abrasion Resistant
K225387 \$69.45 ea.	 • Blower band wear liner • 15 lbs. • To fit New Holland® 1890, 890, 892, 900, 230 & 240 harvesters • K225387BK , mounting hardware, \$9.75 ea., .25 lbs.	225387 Abrasion Resistant
K86636606 \$33.00 ea.	 • Fan paddle • To fit FP230 & FP240 harvesters • FP230: 3 required, FP240: 4 required • 3.6 lbs. • K86636606BK , mounting hardware 1 kit/paddle, \$9.25 ea., .72 lbs.	86636606 Abrasion Resistant
K708652 \$90.45 ea.	 • Wear liner • To fit bottom cutterhead housing door for 2100 & 2115 harvesters • Weld-in application • 28.4 lbs.	Abrasion Resistant
K643627HP (22.8 lbs.) (1900-1915) K643628HP (24.6 lbs.) (2100-2115) \$800.80 ea.	 • Cracker Plate • To fit New Holland® 1900 & 1915 harvesters • To fit New Holland® 2100 & 2115 harvesters • Cracks 85-90% of kernels with minimal power requirements • Bolt-in installation • No moving parts to maintain • Use in whole plant corn silage or to grind earlage • Patent #6,234,072 & #6,327,970	
K9612878 \$210.75	  K86507017 Wear strip: 3 req. \$22.80 ea., 2.7 lbs.  K86507018 Wear strip: 1 req. \$20.30 ea., 1.2 lbs.	9612878 Abrasion Resistant • Rear fan sheet • 52 lbs. • To fit late 1900 SN. 440386 and above, all 1915, 2100 and 2115 harvesters • Wear strips are needed when ordering • K9612878BK : Bolt kit, \$4.25 ea., .35 lbs. 1 required
K630039 \$890.80 ea.	 • Blower gearbox shaft • 8 lbs. • To fit New Holland® 1900, 1915, 2100 & 2115 harvesters	630039 / 287850 287851 / 80287850 8028751 / 80630039
K573730 \$290.75 ea.	 • Blower gearbox shaft • 3.95 lbs. • To fit New Holland® 1900, 1915, 2100 & 2115 harvesters	573730
K643192 \$550.80 ea.	 • Reversing gearbox shaft • 17.5 lbs. • Shaft only - does not include input gear or bearing • To fit all models 1900-2115 equipped w/ electric reversing gear box	643192 / 80643192 89622179 / 9622179
K573907 \$521.05 ea.	 • Cutterhead clutch shaft • 22 lbs. • To fit New Holland® 1900, 1915, 2100 & 2115 harvesters	573907 Heat Treated

Order online at WWW.KOOIMA.COM and receive FREE FREIGHT to your door!



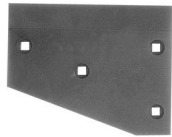





KOOIMA® REPLACEMENT PARTS TO FIT NEW HOLLAND® FORAGE HARVESTERS

Replacement parts produced by Kooima® Company to fit New Holland®

KOOIMA #		DESCRIPTION	REPLACES OEM #
K9829018L \$51.35 ea.		<ul style="list-style-type: none"> Weld on spout transition liner • 5.5 lbs. Will fit spout transitions: 9829018 - model 1915 and 2115 794464 - model 1900 and 2100, 712045 - model 2100, 9621794 - model 1905 1 required per transition 	
K9608019 \$210.75 ea.	  <p>K86507016 Wear strip: 3 required Replaces OEM# 86507016 \$41.00 ea., 1lb. K86507016BK: \$3.75 ea., .05 lbs 3 required</p>	<ul style="list-style-type: none"> Front fan sheet To fit late 1900 SN. 440386 & above, and all 1915 harvesters 36.4 lbs. 	9608019 Abrasion Resistant
K854979 \$290.75 ea.		<ul style="list-style-type: none"> Front fan sheet To fit all 2100 harvesters Includes abrasion resistant wear strips 48.5 lbs. 	854979 Abrasion Resistant
K9621796 \$200.75 ea.	  <p>K86507016 Wear strip: 3 required Replaces OEM# 86507016 \$41.00 ea., 1lb. K86507016BK: \$3.75 ea., .05 lbs. 3 required</p>	<ul style="list-style-type: none"> Front fan sheet To fit all 2115 harvesters 49 lbs. 	9621796 Abrasion Resistant
KP1890 \$5.25 ea.		<ul style="list-style-type: none"> Fan paddle To fit 1890 harvesters 4 required • 4.4 lbs. 	Abrasion Resistant
KP1921 \$44.85 ea.		<ul style="list-style-type: none"> Fan paddle To fit 1900, 1915, 2100 and 2115 harvesters 3 or 4 required • 8 lbs. 	Abrasion Resistant
KP1921WP \$22.30 ea.		<ul style="list-style-type: none"> Wear plate Attaches to fan paddle KP1921 To fit 1900, 1915, 2100 and 2115 harvesters • 2.9 lbs. KP1921WPBK, mounting hardware: \$3.75, .21 lbs. 	9805232 Abrasion Resistant
K574597 \$115.75 ea.		<ul style="list-style-type: none"> Blower band wear liner • 21 lbs. To fit New Holland® 1900, 1915, 2100 and 2115 harvesters K574597BK, mounting hardware: \$4.00 ea., .22 lbs. 	574597 Abrasion Resistant
K683948 \$310.80 ea.		<ul style="list-style-type: none"> Spout liner To fit 1900, 1915, 2100, 2115 and FX series harvesters with New Holland® spouts • 56 lbs. 	683948
K854969 \$50.35 ea.		<ul style="list-style-type: none"> Outer spout deflector To fit all 1915 and 2115 harvesters 6.4 lbs. 	854969
KNHWSC \$300.80 ea.		<ul style="list-style-type: none"> Windshield cover • To fit all FX harvesters • 15.3 lbs. Stainless steel dee rings Eliminates cracked & broken windshields Double sewn heavy duty, padded vinyl construction 	

KOOIMA® REPLACEMENT PARTS TO FIT NEW HOLLAND® FX SERIES FORAGE HARVESTERS





Replacement parts produced by Kooima® Company to fit New Holland®

KOOIMA #		DESCRIPTION	REPLACES OEM #
K89804073 \$490.80 ea.		<ul style="list-style-type: none"> Lower rear smooth feed roll • 70.7 lbs. To fit FX series harvesters up to FX58 Does NOT work with Hydroloc feed roll system 	9804073/89804073
K84036892 \$175.75 ea.		<ul style="list-style-type: none"> Smooth roll cleaner • 14.8 lbs. To fit FX series harvesters up to FX58 Does NOT work with Hydroloc feed roll system 	84036892 Abrasion Resistant Heat Treated
K87700821 \$490.80 ea.		<ul style="list-style-type: none"> Blower band liner To fit FX series harvesters FX30, FX40, FX50 & FX60 (0 series cutters) • 43.2 lbs. 	87700821 & 87381143
K84015418 \$175.00 ea.		<ul style="list-style-type: none"> Rear fan sheet To fit FX series harvesters Does not fit 0 series cutters • 90 lbs. 	84015418 Abrasion Resistant
K84004619 \$85.45 ea.		<ul style="list-style-type: none"> Fan paddle • 7.9 lbs. To fit all FX series harvesters 	84004619 Abrasion Resistant
K84004820 \$35.35 ea.		<ul style="list-style-type: none"> Wear plate • To fit all FX series harvesters Attaches to fan paddle K84004619 Mounting hardware available • 3.7 lbs. 	84004820/84078162 Abrasion Resistant
K84004820BK \$4.25 ea.		<ul style="list-style-type: none"> Wear plate bolt kit To fit all FX series harvesters • .2 lbs. 	
K84023856 \$150.75 ea.		<ul style="list-style-type: none"> Blower band wear liner • 29 lbs. To fit FX series harvesters Will not fit an FX60 or any FR models 	84023856 Abrasion Resistant

New Holland® processor rolls to fit most New Holland® models

All rolls are the saw tooth high-capacity design, heat treated, and include heavy duty 1-piece shaft.
Match your processor to the descriptions below:



K84019783B (Bottom roll w/ sensor bushing) K84019783T (Top roll) \$1,350.00 ea. (May have to update pulleys- order 87571365 - 87571367 from New Holland®)	<ul style="list-style-type: none"> Replaces OEM 3-piece KP rolls Tapered keyed shaft beneath pulley To fit FX25, FX45, early FX28/38/58 • 150.5 lbs.  Left hand belt drive
K84455049 (hydraulic drive) \$1,515.00 ea.	<ul style="list-style-type: none"> Lower roll hydraulic drive/upper roll belt drive To fit FX28, FX38, FX58 harvesters To fit FX40, FX50, FX60 before serial # 111305111 • 150.5 lbs. 
K84073406 (double belt drive, 100 tooth) \$1,350.00 ea.	<ul style="list-style-type: none"> Belts on both sides of KP To fit late FX28, FX38, FX58 harvesters To fit FX40, FX50, FX60 (most common on late models) • 150.5 lbs. 
K84073406HPF (Front, 100 tooth) K84073406HPR (Rear, 110 tooth) \$1,820.00 ea.	<ul style="list-style-type: none"> Belts on both sides of KP To fit late FX28, FX38, FX58 harvesters To fit FX40, FX50, FX60 (most common on late models) Chevron Series Fiber Tech for extreme processing Heat Treated and Chromed  Double belt drive
K8441190 (Top) (late hydraulic drive) K8441190DB (Bottom) \$1,515.00 ea.	<ul style="list-style-type: none"> Hydraulic drive after serial # 111306111 Lower roll hydraulic/upper roll belt • 150.5 lbs.  Long shaft on both ends on upper roll • To fit FX40, FX50, FX60 harvesters



K22208C3 \$65.80 ea.	 <ul style="list-style-type: none"> Kernel processor bearing To fit all FX kernel processor rolls • 2 lbs. 	SKF22208C3
--------------------------------	---	------------

Truck icon signifies product is shipped via truck freight.

Order online at WWW.KOOIMA.COM and receive **FREE FREIGHT** to your door!



KOOIMA® REPLACEMENT PARTS TO FIT NEW HOLLAND® FX SERIES FORAGE HARVESTERS

New Holland® is a registered trademark of CNH Industrial America, LLC, which does not manufacture, distribute or endorse these parts.

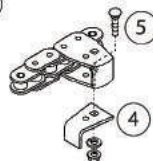
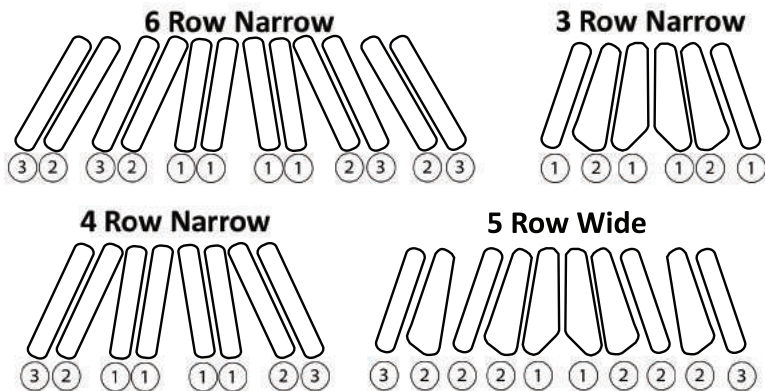

New Holland® 360N/W Gathering Chains- Quality US Made Chains



- K102009** - \$34.50 ea.
- Gathering chain - 8 lug • 9.5 lbs.
 - To fit New Holland® 98D, 974 & 996 corn heads
 - Replaces OEM # AN102009/610831/176279C91

KOOIMA #	DESCRIPTION	REPLACES OEM #
K86593262 \$310.80 ea.	① • Corn head chain • 92 pitch • 20.3 lbs.	86593262 86502834
K86593264 \$325.80 ea.	② • Corn head chain • 96 pitch • 21.2 lbs.	86593264 86502835
K86593263 \$275.75 ea.	③ • Corn head chain • 88 pitch • 19.4 lbs.	86593263
K86633815 \$11.25 ea.	④ • Chain scraper • 3 required per chain (1 chain per row with scrapers) • .15 lbs.	86633815 9845441
K86633815BK \$3.75 ea.	⑤ • Bolt Kit • To fit K86633815 chain scraper • 1 kit required per scraper • .10 lbs.	

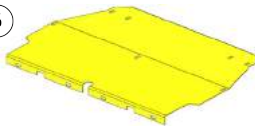
K9843538 \$190.00 ea.		• Row crop disc • To fit New Holland® 360 N corn heads • 5.8 lbs.	9843538 Heat Treated Tungsten Carbide
---------------------------------	--	---	---

K9843298 \$110.75 ea.	⑥ 	• Corn head floor extension • 25 lbs. • To fit New Holland® 360N4 and 360N6 corn heads	REPLACES OEM # 9843298
K9622566 \$37.85 ea.	⑦ 	• Pick up head floor extension • 11 lbs. • To fit New Holland® 340W and 350W pick ups	9622566

Kooima® hay pick-up teeth are manufactured from hi-tensile drawn spring wire for uniform strength and durability.

Order # **K131673**
\$1.90 ea.



- Pick-up tooth
- To fit most New Holland® forage harvester hay heads
- .5 lbs.
- Replaces OEM # 86632007BDS

Order # **K84390221**

\$8.70 ea.



- Pick-up tooth - 7.40" long
- To fit New Holland® 270FP, 280FP, 290FP & 380FP hay heads
- Replaces OEM # 84390221

Kemper™ style Crop Dividers to fit New Holland® RI 600 series corn heads

The RI heads are great, but have a tendency to double cut the stalk, leaving a trail of 6-8 inch long chunks lying in the field. This new Crop Divider holds the stalk up and in tighter to the drum for a single clean cut with no waste. Our customers notice the difference and so will you! We ran them on our RI head and loved them. Call today for more details.

Order # **K600PAKIT**
(to fit RI 600 8-row)

- Uses 2 RH, 2 LH assemblies

\$2,550⁰⁰ ea. 276 lbs. 

Order # **K450PAKIT**
(to fit RI 450 6-row)

- Uses 2 RH, 1 LH assemblies

\$2,050⁰⁰ ea. 180 lbs. 











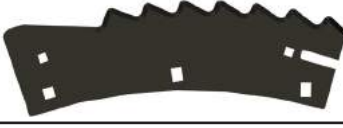

K600PAKIT and K450PAKIT use existing mounting holes and no additional hardware is required.

See page 157 for more information on the individual parts along with a diagram.

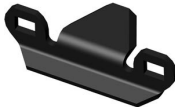
New Holland® is a registered trademark of CNH Industrial America, LLC • Kemper™ is a trademark of Maschinenfabrik KEMPER GmbH & Co. Truck icon signifies product is shipped via truck freight.

KOOIMA® REPLACEMENT PARTS TO REPLACE NEW HOLLAND® RI SERIES ROTARY HEADS

Replacement parts produced by Kooima® Company to fit New Holland®

KOOIMA #		DESCRIPTION	REPLACES OEM #
K9963130		<ul style="list-style-type: none"> Flat cutting blade To fit right hand & center drums on RI 450 & RI 450XTRA 6-row heads 20 required on heads with SN. 66002621 & below 10 required on heads SN. 66002622 & above 10 required on RI 450XTRA heads • 1.7 lbs. 	9963130 Heat Treated Tungsten Carbide
K9995490		<ul style="list-style-type: none"> Flat cutting blade To fit right hand & center drums on RI 450XTRA 6-row heads 10 required • 1.7 lbs. 	9995490 Heat Treated Tungsten Carbide
K9963100		<ul style="list-style-type: none"> Flat cutting blade To fit left hand drums on RI 450 & RI 450XTRA 6-row heads 10 required on heads SN. 66002621 & below 5 required on heads SN. 66002622 & above 5 required on RI 450XTRA heads • 1.7 lbs. 	9963100 Heat Treated Tungsten Carbide
K9995540		<ul style="list-style-type: none"> Flat cutting blade To fit left hand drums on RI 450XTRA 6-row heads 5 required • 1.7 lbs. 	9995540 Heat Treated Tungsten Carbide
KRU450BK		<ul style="list-style-type: none"> Metric bolt kit To fit RI 450 6-row heads 1 kit required per head • 10.25 lbs. 	
KRU600BK		<ul style="list-style-type: none"> Metric bolt kit To fit RI 600 8-row heads 1 kit required per head • 13.5 lbs. 	
K9919821		<ul style="list-style-type: none"> Blade scraper To fit RI 450XTRA heads & RI450 IF using XTRA style blades To fit RI 600 8-row heads 15 required for 450; 20 required for 600 • .15 lbs. 	9919822 Heat Treated Tungsten Carbide
K9961221		<ul style="list-style-type: none"> Drum scraper • 2 required per drum To fit New Holland® RI 450 and RI 450XTRA series heads • .6 lbs. 	9961221 Abrasion Resistant
K9968071		<ul style="list-style-type: none"> Reinforcement • 5 required per rotor To fit New Holland® RI 450 and RI 450XTRA heads • .05 lbs. 	9968071 Abrasion Resistant
K9998170		<ul style="list-style-type: none"> Flat cutting blade To fit right hand and center drums on RI 600XTRA 8-row heads 20 required • 2.5 lbs. 	9998170 Heat Treated Tungsten Carbide
K9998160		<ul style="list-style-type: none"> Flat cutting blade To fit left hand and center drums on RI 600XTRA 8-row heads 20 required • 2.5 lbs. 	9998160 Heat Treated Tungsten Carbide
K9906070		<ul style="list-style-type: none"> Skid plate To fit RI 600 8-row heads 4 required • 14 lbs. 	9906070 Abrasion Resistant

TO ORDER CALL TOLL FREE 1-800-522-8874



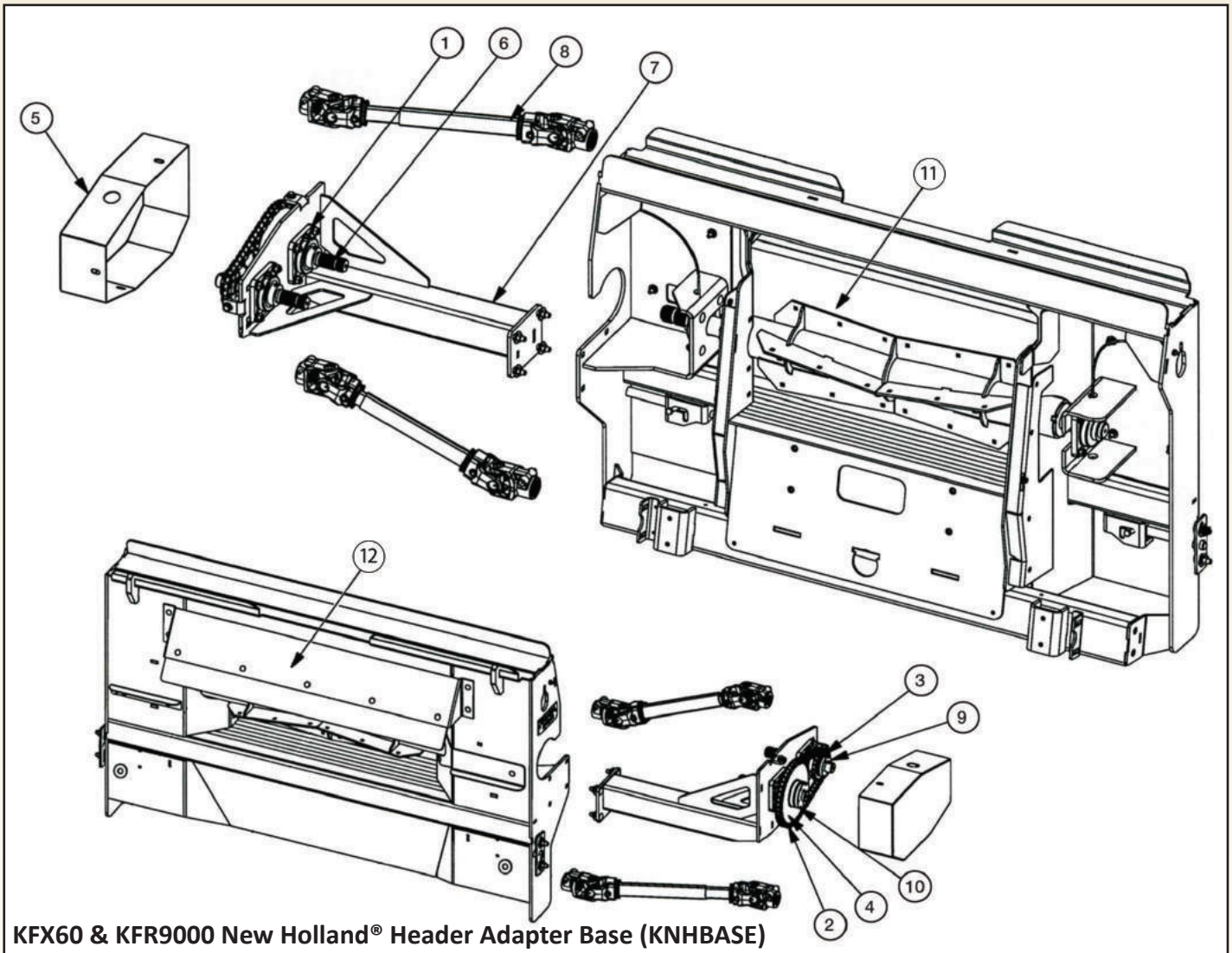

KFX60 & KFR9000 New Holland® Header Adapter Base (KNHBASE)

KOOIMA #	PRICE	DESCRIPTION
① 15-4BOLT-LC	\$75.45 ea.	• Bearing Ø 1.50", 4-bolt flange, lock collar • 4 required • 4.75 lbs.
② 60H-54	\$40.35 ea.	• #60 heavy roller chain, 54 pitches • 4.2 lbs.
③ 60P19H	\$75.45 ea.	• #60 sprocket, 19 tooth, QD hub • 2.6 lbs.
③ 60SDS21	\$60.45 ea.	• #60 sprocket, 21 tooth, QD hub • 2.3 lbs.
④ 60SK40	\$110.00 ea.	• #60 sprocket, 40 tooth, QD hub • 9.3 lbs.
⑤ FH003118	\$60.00 ea.	• Chain cover, flap drive • 9.8 lbs.
⑥ FH003259	\$80.45 ea.	• 1 1/2 - 23 splined stub shaft, flap drive • 2 required • 5.13 lbs.
⑦ FH5000990	\$200.75 ea.	• Flap drive weldment
⑧ KFXPTO	\$345.00 ea.	• PTO, FX adapter, W2400 • 2 required • 25.9 lbs.
⑨ P11.5	\$35.35 ea.	• P1 bushing, for 1-1/2 shaft • 1 lb.
⑩ SK1.5	\$40.35 ea.	• QD bushing, SK series, 1.50 shaft • 2.93 lbs.
⑪ FH5000987	\$750.80 ea.	• Flap wheel • 111 lbs.
⑫ FH003126KIT	\$90.45 ea.	• Front deflector plate • 20 lbs.

Order parts 1-10 listed above in a COMPLETE assembly

- Ready to go
- Price includes 2 PTO shafts & 2 bearings
- 157 lbs./kit

Order # KFLAPDRIVEKIT

Only
\$1,250⁰⁰ ea.

KOOIMA® REPLACEMENT PARTS TO FIT NEW HOLLAND® FR / FX HEADER ADAPTERS

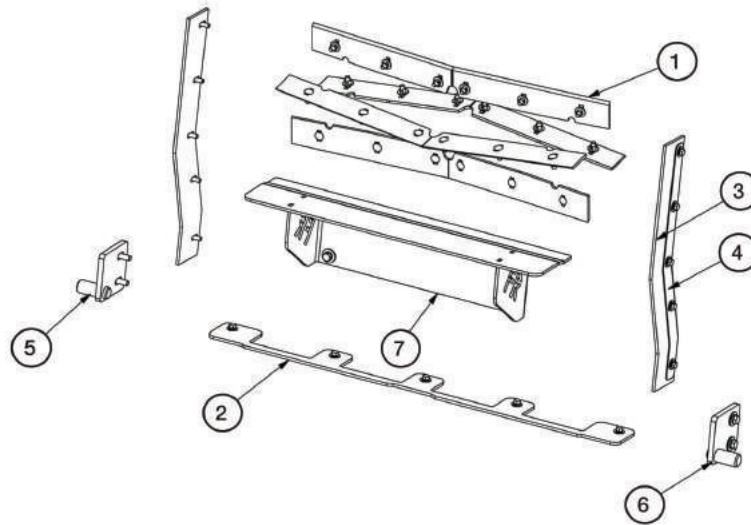

KFR9000 Kit

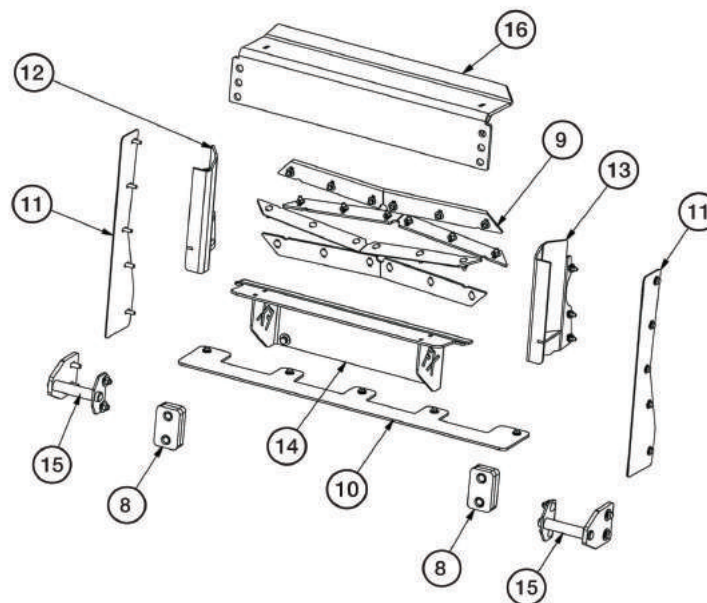

KFX60 Kit

	KOOIMA #	PRICE	DESCRIPTION
①	FH003026	\$35.35 ea.	• Tooth, FR flap wheel, 4 required • 5.85 lbs.
②	FH003032	\$25.30 ea.	• Bottom rubber flap • .9 lbs.
③	FH003033	\$25.30 ea.	• Side rubber flap • 1.05 lbs.
④	FH003148	\$10.25 ea.	• Flap cover plate • 1 lb.
⑤	FH5000985	\$35.35 ea.	• Left rear FR connect pin weldment • 3.9 lbs.
⑥	FH5000986	\$35.35 ea.	• Right rear FR connect pin weldment • 3.9 lbs.
⑦	FH5000989	\$85.45 ea.	• FR floor plate extension • 29.5 lbs.
⑧	FH002993	\$20.30 ea.	• FX lower contact pad • 2.9 lbs.
⑨	FH003015	\$25.30 ea.	• Tooth, FX flap wheel, 4 required • 4.7 lbs. ea.
⑩	FH003236	\$25.30 ea.	• Bottom steel plate
⑪	FH003252	\$25.30 ea.	• Side seal, FX version, 2 required
⑫	FH5000991	\$65.45 ea.	• LH FX throat narrowing plate • 8.3 lbs.
⑬	FH5000992	\$65.45 ea.	• RH FX throat narrowing plate • 8.3 lbs.
⑭	FH5000993	\$95.45 ea.	• FX floor extension
⑮	FH5000996	\$65.45 ea.	• FX lower pin weldment, 2 required • 6.4 lbs.
⑯	FH5000998	\$135.75 ea.	• Hanger weldment

Truck icon signifies product is shipped via truck freight.

TO ORDER CALL TOLL FREE 1-800-522-8874















Kooima® Replacement Parts To Fit CASE IH®

KOOIMA® REPLACEMENT PARTS TO FIT CASE IH® FORAGE HARVESTERS



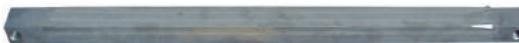



Case IH® is a registered trademark of CNH Industrial America, LLC, which does not manufacture, distribute or endorse these parts.

Replacement parts produced by Kooima® Company to fit Case IH®

KOOIMA #	DESCRIPTION	REPLACES OEM #
K122266  \$89.50 ea.	<ul style="list-style-type: none"> • Knife • To fit Case IH® 674, 720 and 781 • 12 required • 6.5 lbs. 	127110C1 122266C1 Heat Treated Tungsten Carbide
K127111  \$93.50 ea.	<ul style="list-style-type: none"> • Knife • To fit Case IH® 830 and 881 • 12 required • 7.7 lbs. 	127111C1 Heat Treated Tungsten Carbide
K700714442  \$96.50 ea.	<ul style="list-style-type: none"> • Knife • To fit Case IH® 8750 • 10 required • 6.4 lbs. 	700712523 700714442 Heat Treated Tungsten Carbide
K86624446  \$77.95 ea.	<ul style="list-style-type: none"> • Knife • To fit Case IH® FHX300 • 8.5 lbs. • 12 required • Also fits New Holland® FP240 	86624446 Heat Treated Tungsten Carbide
K122284  \$3.50 ea.	<ul style="list-style-type: none"> • Knife bolt • To fit Case IH® 720, 781, 830 and 881 • .6 lbs. 	122284C1
K481540  \$4.50 ea.	<ul style="list-style-type: none"> • Special knife washer • To fit all Case IH® harvesters • .2 lbs. 	481540R1
K122086  \$245.75 ea.	<ul style="list-style-type: none"> • Shearbar • 10.3 lbs. • To fit Case IH® 720 & 781 harvesters 	122086C1 Heat Treated Tungsten Carbide
K102176  \$250.75 ea.	<ul style="list-style-type: none"> • Shearbar • To fit Case IH® 830 & 881 harvesters • 11 lbs. 	102176C1 Heat Treated Tungsten Carbide
K1705136  \$135.75 ea.	<ul style="list-style-type: none"> • Shearbar • To fit Case IH® 8710, 8720 and 8730 harvesters • 8.7 lbs. 	700714233 1705136 Heat Treated Tungsten Carbide
K700713445  \$325.80 ea.	<ul style="list-style-type: none"> • Shearbar • To fit Case IH® 8750 series harvesters • 21.8 lbs. 	700713445 Heat Treated Tungsten Carbide
K86632157  \$310.80 ea.	<ul style="list-style-type: none"> • Shearbar • To fit Case IH® FHX300 series harvesters • Also fits New Holland® FP240 • 18.5 lbs. 	86632157 Heat Treated Tungsten Carbide
K127195  \$59.35 ea.	<ul style="list-style-type: none"> • Sharpening stone • To fit Case IH® 720, 781, 830, 881 harvesters • 2.4 lbs. 	127195C1

Case® and Case IH® are registered trademarks of CNH Industrial America, LLC



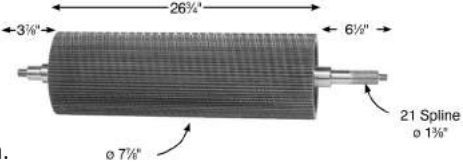

KOOIMA® REPLACEMENT PARTS TO FIT CASE IH® FORAGE HARVESTERS

KOOIMA #	DESCRIPTION	REPLACES OEM #
K9805207 \$67.95 ea.		<ul style="list-style-type: none"> • Sharpening stone, 3" dia. • To fit Case IH® FHX 300 • Also fits New Holland® 1900, 1905, 2115, FP230, FP240 and FX series • 3.5 lbs.
K240FR \$495.80 ea.		<ul style="list-style-type: none"> • Feed roll top back • To fit Case IH® FHX 300 & New Holland® FP240 • Heavier tooth helps eliminate any feeding issues • 43 lbs.
K86512516 \$360.00 ea.		<ul style="list-style-type: none"> • Smooth roll • To fit Case IH® FHX 300 & New Holland® FP240 • 37.1 lbs.
K86635936 \$155.00 ea.		<ul style="list-style-type: none"> • Smooth Roll Scraper • To fit Case IH® FHX 300 & New Holland® FP240 • 13.8 lbs.
K225387 \$69.45 ea.		<ul style="list-style-type: none"> • Blower band wear liner • 15 lbs. • To fit Case IH® FHX 300 • K225387BK - Bolt Kit, \$9.75 ea., .25 lbs.
K86636606 \$33.00 ea.		<ul style="list-style-type: none"> • Fan paddle • To fit Case IH® FHX 300 • 4 required • 3.6 lbs. • K86636606BK - Bolt kit, 1 kit/paddle, \$9.25 ea., .72 lbs.
K240DC \$1,290.00 ea.		<ul style="list-style-type: none"> • Processor roll • To fit Case IH® FHX300 and New Holland® FP240 factory processors • 100 tooth • Dual cut for better processing • 2 required

Replacement parts produced by Kooima® Company to fit Case IH®

KOOIMA® REPLACEMENT PARTS TO FIT FOX® FORAGE HARVESTERS

Fox® is a registered trademark of Hiniker Company, which does not manufacture, distribute or endorse these parts.

KOOIMA #	DESCRIPTION	REPLACES OEM #
K10005 \$82.15 ea.		<ul style="list-style-type: none"> • Knife • To fit all Fox® 6-knife models • 6 required • 6.4 lbs.
K10013 \$82.15 ea.		<ul style="list-style-type: none"> • Knife • To fit all Fox® 8-knife models • 8 required • 6.5 lbs.
K14001 \$137.50 ea.		<ul style="list-style-type: none"> • Shearbar • To fit all Fox® 6 and 8-knife models • Tungsten carbide hard faced • 6.6 lbs.
K760180 \$9.75 ea.		<ul style="list-style-type: none"> • 3/4" knife bolt and nut • To fit Fox® harvesters • .6 lbs.







Replacement parts produced by Kooima® Company to fit Fox®

Order online at WWW.KOOIMA.COM and receive **FREE FREIGHT** to your door!

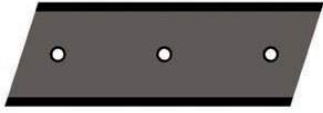

KOOIMA® REPLACEMENT PARTS TO FIT FOX® FORAGE HARVESTERS

Replacement parts produced by Kooima® Company to fit Fox®

KOOIMA #		DESCRIPTION	REPLACES OEM #
K301		<ul style="list-style-type: none"> Sharpening stone To fit all Fox® harvesters 3 lbs. 	F102-10000
K11000		<ul style="list-style-type: none"> Row crop knife To fit models 2CA, 2CB, 122, 215, 236 & 763 Fox® corn heads 1 lb. 	F101-11000 Heat Treated Tungsten Carbide
K00017		<ul style="list-style-type: none"> Left hand stationary knife To fit models 711, 725, 726, 745, 746, 751, & 753 belted corn heads • 1.6 lbs. 	101-00017 Heat Treated Tungsten Carbide
K00018		<ul style="list-style-type: none"> Right hand stationary knife To fit models 711, 725, 726, 745, 746, 751, & 753 belted corn heads • 1.6 lbs. 	101-00018 Heat Treated Tungsten Carbide
KF12016		<ul style="list-style-type: none"> 5-point rotary knife Original style preferred by many harvesters To fit models 7234, 7334, 7430, & 7480 chain corn heads 1 required per row • 2.7 lbs. 	101-12016 Heat Treated Tungsten Carbide
KF12018		<ul style="list-style-type: none"> 10-point rotary knife Non-beveled edge, optional with #K01388 To fit models 7234, 7334, 7430 & 7438 chain corn heads 1 required per row • 3.5 lbs. 	101-12018 Heat Treated
K01095		<ul style="list-style-type: none"> Stationary knife To fit models 7234, 7334, 7430, & 7438 chain corn heads 1 required per row • .7 lbs. 	792-01095 Heat Treated Tungsten Carbide

Fox® is a registered trademark of Hiniker Company.

SILAGE TESTER

- Tests freshly chopped and ensiled silage.
- Tester stays clean; plastic bags prevent contamination of test cell.
- Tests in one minute.
- Digital log reading with conversion chart for common silage types.
- Accurate within 2% (average) for silage under 50% moisture.
- Accurate within 3% (average) for silage over 50% moisture.
- Accurate within 1% for grain at normal stored moisture.
- Testing range: 30% - 75% (silage), 10% - 47% (grain).
- Full one year warranty. • 4 lbs.

Silage Tester
Order # K1210
Only
\$325⁸⁰ea.

Replacement Bags
100 Count
Order # K06801
\$25³⁰ea.











KOOIMA® REPLACEMENT PARTS TO FIT GEHL® FORAGE HARVESTERS

Gehl® is a registered trademark of Manitou Americas, Inc., which does not manufacture, distribute or endorse these parts.

Replacement parts produced by Kooima® Company to fit Gehl®

Kooima® knives and shearbars are:

- Manufactured to exact specifications
- Heat treated for edge hardness and durability
- Made in the USA
- Made of high carbon steel
- Tungsten carbide edge for maximum wear

KOOIMA #	DESCRIPTION	REPLACES OEM #
K07777  \$97.10 ea.	<ul style="list-style-type: none"> • Knife • To fit Gehl® CB600HYD • 6 required • 8 lbs. 	077821 077777 Heat Treated Tungsten Carbide
K07777  \$97.10 ea.	<ul style="list-style-type: none"> • Knife • To fit Gehl® CB700, CB750, CB760, CB800, CB860, CB865, CB1000, CB1040, CB1060, CB1065, 1075 & 1085 (SN. 14149 & below) • 8 required • 8 lbs. 	077821 077777 Heat Treated Tungsten Carbide
K061840  \$103.50 ea.	<ul style="list-style-type: none"> • Knife • To fit Gehl® CB1200, CB1250, CB1260, CB1265, CB1275 & 1285 (SN. 20899 & below) • 9 required • 10 lbs. 	062368 061840 Heat Treated Tungsten Carbide
K055287  \$125.75 ea.	<ul style="list-style-type: none"> • Shearbar • To fit Gehl® CB300, CB400, CB600EL, CB600HYD, CB700 & CB800 • 6.6 lbs. 	055287 Heat Treated Tungsten Carbide
K071880  \$160.75 ea.	<ul style="list-style-type: none"> • Shearbar • To fit Gehl® CB750, CB760, CB860 and CB865 • 31 3/4" long • 9.1 lbs. 	071880 Heat Treated Tungsten Carbide
K071832  \$200.00 ea.	<ul style="list-style-type: none"> • Shearbar • To fit Gehl® CB1060, CB1065, & model CB1000 SN. 1854 & above, 1075 & 1085 • 9.6 lbs. 	071832 Heat Treated Tungsten Carbide
K077237  \$215.75 ea.	<ul style="list-style-type: none"> • Shearbar • To fit Gehl® CB1250, CB1260, CB1265, CB1275 & 1285 • 11 lbs. 	077237 Heat Treated Tungsten Carbide
K301  \$95.45 ea.	<ul style="list-style-type: none"> • Sharpening stone • To fit all Gehl® harvesters except CB300, 1085 & 1285 • 3 lbs. 	076557
K061267  \$3.05 ea.	<ul style="list-style-type: none"> • Knife bolt • To fit CB600 to CB1275 • .4 lbs. 	061267

TO ORDER CALL TOLL FREE 1-800-522-8874



KOOIMA® REPLACEMENT PARTS TO FIT GEHL® FORAGE HARVESTERS

Replacement parts produced by Kooima® Company to fit Gehl®

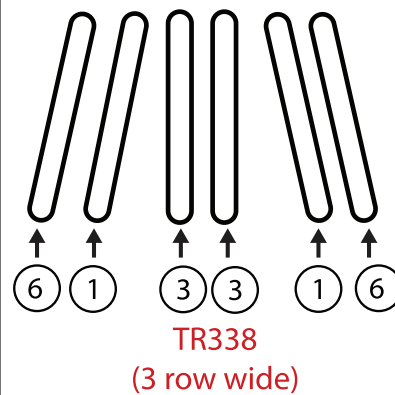
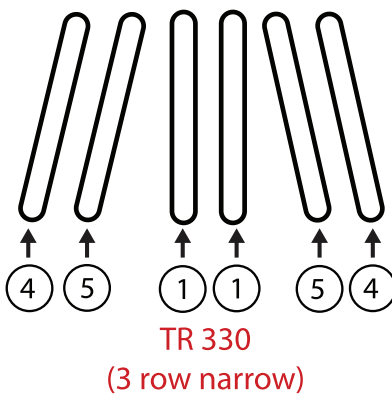
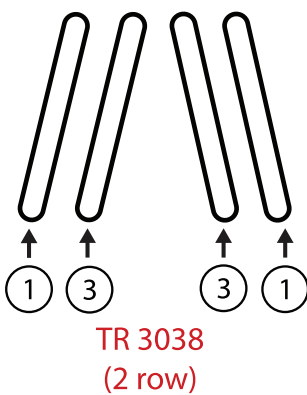
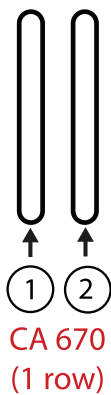

KOOIMA #
K074646

①

\$340.00 ea.



DESCRIPTION

- Gathering belt assembly
- 54 links • 19.2 lbs.
- 1 required to fit Gehl® CA670 (left hand)
- 2 required to fit Gehl® TR3038 (outside)
- 2 required to fit Gehl® TR330 (center)
- 2 required to fit Gehl® TR338 (inside)

REPLACES OEM #
074646

K074642

②

\$325.00 ea.



- Gathering belt assembly
- 52 links • 18.6 lbs.
- 1 required to fit Gehl® CA670 (right hand)

074642

K074650

③

\$285.00 ea.



- Gathering belt assembly
- 46 links • 16.2 lbs.
- 2 required to fit Gehl® TR3038 (inside)
- 2 required to fit Gehl® TR338 (center)

074650

K074658

④

\$380.00 ea.



- Gathering belt assembly
- 60 links • 21.3 lbs.
- 2 required to fit Gehl® TR330 (outside)

074658

K074654

⑤

\$325.00 ea.



- Gathering belt assembly
- 50 links • 17.8 lbs.
- 2 required to fit Gehl® TR330 (inside)

074654

K074666

⑥

\$350.00 ea.





- Gathering belt assembly
- 66 links • 24.4 lbs.
- 2 required to fit Gehl® TR338 (outside)

074666

Gehl® is a registered trademark of Manitou Americas, Inc.

KOOIMA® REPLACEMENT PARTS TO FIT GEHL® FORAGE HARVESTERS

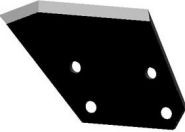
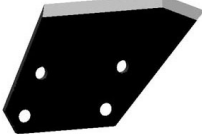
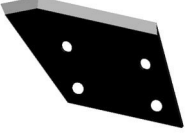
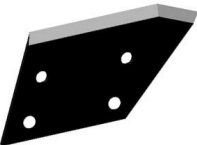
<u>KOOIMA #</u>		<u>DESCRIPTION</u>	<u>REPLACES OEM #</u>
K059076 \$110.75 ea.		<ul style="list-style-type: none"> • Rotary cutting blade • To fit Gehl® 330, 338 & 3038 corn heads • 3 required • 3.5 lbs. 	059076 Heat Treated
K073456 \$35.35 ea.		<ul style="list-style-type: none"> • Right hand stationary knife • To fit Gehl® 330 & 338 corn heads SN. 1201 & above and 3038 • 1 required • .7 lbs. 	073456 Heat Treated Tungsten Carbide
K073457 \$35.35 ea.		<ul style="list-style-type: none"> • Left hand stationary knife • To fit Gehl® 330 & 338 corn heads SN. 1201 & above and 3038 • 2 required • .7 lbs. 	073457 Heat Treated Tungsten Carbide
K057069 \$13.80 ea.		<ul style="list-style-type: none"> • Right hand stationary knife • To fit Gehl® 330 & 338 corn head SN. 1200 and below • 1 required • .6 lbs. 	057069 Heat Treated
K057070 \$13.80 ea.		<ul style="list-style-type: none"> • Left hand stationary knife • To fit Gehl® 330 & 338 corn head SN. 1200 & below • 2 required • .6 lbs. 	057070 Heat Treated





Replacement parts produced by Kooima® Company to fit Gehl®

KOOIMA® REPLACEMENT PARTS TO FIT HESSTON® FIELD QUEEN™ FORAGE HARVESTERS

Hesston® is a registered trademark of AGCO Corporation, which does not manufacture, distribute or endorse these parts.

Kooima® knives and shearbars are:

- Manufactured to exact specifications
- Heat treated for edge hardness and durability
- Made in the USA
- Made of high carbon steel
- Tungsten carbide edge for maximum wear

<u>KOOIMA #</u>		<u>DESCRIPTION</u>	<u>REPLACES OEM #</u>
K748244 \$80.50 ea.		<ul style="list-style-type: none"> • Universal Knife • 6.8 lbs. • To fit Hesston® 2000, 2000-100, 2000-150, 4000, 7000, 7140, 7150, 7600, 7650, 7655 and 7660 • 6 required 	748244 Heat Treated Tungsten Carbide
K1705136 \$135.75 ea.		<ul style="list-style-type: none"> • Shearbar • 8.7 lbs. • To fit Hesston® 2000, 2000-100, 2000-150, 4000, 7000, 7140, 7150, 7600, 7650, 7655, 7660, 7145, 7155 & 7165 	1705136 Heat Treated Tungsten Carbide
K745802 \$90.45 ea.		<ul style="list-style-type: none"> • Shearbar • 8.1 lbs. • To fit Hesston® 7020 	745802 Heat Treated Tungsten Carbide

Replacement parts produced by Kooima® Company to fit Hesston® Field Queen™

Field Queen™ is a trademark of AGCO Corporation.

Order online at WWW.KOOIMA.COM and receive **FREE FREIGHT** to your door!

KOOIMA®
COMPANY





201

KOOIMA® REPLACEMENT PARTS TO FIT FORD® FORAGE HARVESTERS

Ford® is a registered trademark of Ford Motor Company, which does not manufacture, distribute or endorse these parts.









Replacement parts produced by Kooima® Company to fit Ford®

KOOIMA #	DESCRIPTION	REPLACES OEM #
K122266 \$89.50 ea.	 • Knife • 6.5 lbs. • To fit Ford® 670 • 12 required	122266C1 Heat Treated Tungsten Carbide
K127111 \$93.50 ea.	 • Knife • 7.7 lbs. • To fit Ford® 672 • 12 required	127111C1 Heat Treated Tungsten Carbide

KOOIMA® REPLACEMENT PARTS TO FIT NEW IDEA® FORAGE HARVESTERS

New Idea® is a registered trademark of AGCO Corporation, which does not manufacture, distribute or endorse these parts.

Replacement parts produced by Kooima® Company to fit New Idea®

KOOIMA #	DESCRIPTION	REPLACES OEM #
K122266 \$89.50 ea.	 • Knife • To fit New Idea® 660 and 662 • 12 required • 6.5 lbs.	122266C1 Heat Treated Tungsten Carbide
K762178 \$97.50 ea.	 • Knife • To fit New Idea® 767K • 6 required • 6.3 lbs.	762178 Heat Treated Tungsten Carbide
K764721 \$97.50 ea.	 • Knife • To fit New Idea® 868K & 6200 • Note: Always tighten center bolt first • 8 required • 6.5 lbs	764721 Heat Treated Tungsten Carbide
K762026 \$30.35 ea.	 • Shearbar • To fit New Idea® 760K • 5.5 lbs.	762026 Heat Treated Tungsten Carbide
K762179 \$135.75 ea.	 • Shearbar • To fit New Idea® 767K • 10.9 lbs.	762179 Heat Treated Tungsten Carbide
K764630 \$350.80 ea.	 • Shearbar • To fit New Idea® 868K & 6200 • 10.6 lbs.	764630 Heat Treated Tungsten Carbide
K764630AD \$10.25 ea.	 • Adjusting bolt • .14 lbs. • To fit K764630 shearbar • 2 required	
K301 \$95.45 ea.	 • Sharpening stone • 3 lbs • To fit New Idea® 767K and 868K harvesters • Bolt kit: KBK, \$3.25 ea., .1 lb.	762698
K760180 \$9.75 ea.	 • 3/4" knife bolt and nut • To fit New Idea® 760K, 767K and 868K harvesters • .6 lbs.	760180

Kooima® Replacement No-Till Drill Parts

John Deere® and JD® are registered trademarks of Deere & Company, which does not manufacture, distribute or endorse these parts.

KOOIMA® REPLACEMENT PARTS TO FIT JOHN DEERE® No-Till Drills

- Kooima® seed boots to fit all 750 and 1850 John Deere® no-till drills
- Manufactured of high quality ductile steel, our seed boots are heat treated to meet or exceed OEM specifications.
- Replaces OEM #N284024 (RH) & N284025 (LH) • 6.7 lbs. ea.

Order # K280446 (RH)

Order # K280447 (LH)

\$30³⁵ ea.



- 18" Disc opener to fit all 750 and 1850 John Deere® no-till drills
- At .197" thick, this is without a doubt the best opener blade on the market. • 13 lbs. • Replaces OEM # N283804 / N214190

Order # K214190

\$27⁵⁵ ea.



- Gauge wheel tire to fit all 750 and 1850 John Deere® no-till drills
- Replaces OEM # A22884 /A84050 • 7.4 lbs.

Order # K22884

\$28³⁰ ea.



- Seed boot pressure spring to fit all 750, 1850 & 1895 John Deere® no-till drills

- Replaces OEM #N280485, N280455 • .2 lbs.

Order # K284055

\$3⁷⁵ ea.



- Poly seed flap, reduces seed bounce • To fit 750, 1590, 1690, 1850, 1890, 1895 & 1990 JD® grain drills

- 1 required per seed boot

- Replaces OEM # N219982 • .1 lbs.

Order # K219982

\$1⁸⁰ ea.



SAVE When You Buy Any Kit!

Order part # K750-15 to repair your 15 ft. 750/1850 drill

- 700 lbs.

Kit contains:

- 24 Seed Boots
- 24 Disc Openers
- 24 Gauge Wheel Tires

Only

\$1,965⁰⁰ ea.

*Free freight!



Order part # K750-20 to repair your 20 ft. 750/1850 drill

- 920 lbs.

Kit contains:

- 32 Seed Boots
- 32 Disc Openers
- 32 Gauge Wheel Tires

Only

\$2,620⁰⁰ ea.

*Free freight!



Order part # K750-30 to repair your 30 ft. 750/1850 drill

- 1,400 lbs.

Kit contains:

- 48 Seed Boots
- 48 Disc Openers
- 48 Gauge Wheel Tires

Only

\$3,930⁰⁰ ea.

*Free freight!



TO ORDER CALL TOLL FREE 1-800-522-8874

KOOIMA®
COMPANY



203

Kooima® Replacement No-Till Drill Parts

KOOIMA® REPLACEMENT PARTS TO FIT JOHN DEERE® No-Till Drills

DISC OPENER
Order # K214190

\$27⁵⁵ ea.

- 18" Disc opener to fit 750, 1560, 1565, 1590, 1850, 1860, 1865, 1890, 1895 John Deere® no-till drills.
- At .197" thick, this is without a doubt the best opener blade on the market.
- Replaces OEM #N214190/N283804
- 13 lbs.



GAUGE WHEEL TIRE
Order # K22884

\$28³⁰ ea.

- To fit John Deere® models 610, 750, 1560, 1565, 1590, 1690, 1850, 1860, 1890, 1865, 1869, 1895 grain drills and air seeders
- ALSO FITS Kinze® planters and White® 6100 series planters
- Replaces OEM #A84050/A22884
- 7.4 lbs.



BEARING
Order # K281357

\$5⁷⁵ ea.

- Bearing for all rubber seed firming wheels
- To fit John Deere® models 1850, 1060, 730, 770, 780 air seeders
- To fit John Deere® models 1520, 450, 455, 515, 320, 750, 8000 and 9400 grain drills
- Replaces OEM #AN281357
- .2 lbs.



BEARING
Order # K212132

\$8⁹⁵ ea.

- Closing wheel bearing
- To fit John Deere® models 1850, 610 and 750 grain drills and air seeders
- ALSO FITS Kinze® planters and White® 6100 series planters
- Replaces OEM #AN212132
- .5 lbs.



BEARING
Order # KJRM3049

\$25³⁰ ea.

- DOUBLE TAPER disc opener bearing
- To fit John Deere® 1560, 1565, 1860, 750A, 1690, 1890, 1895 & 1590 air seeder blade
- Replaces OEM #AN281856, AN281813
- .9 lbs.



Kooima® Replacement No-Till Drill Parts

Check out these Grain Drill/Air Drill seeder parts now available!

SEED BOOT

Order # K283432 (RH)
Order # K283433 (LH)

\$26⁸⁰ ea.

- To fit 1560, 1565 & 1860 John Deere® grain drill/air drill.
- Replaces OEM # N283432, N283433, N282883, N282884
- Right hand shown
- 2.9 lbs.



CLOSING WHEEL

Order # K38447

\$24⁸⁰ ea.

- 1x10 closing wheel to use with bearing
- To fit 750 SN. 5282, 1560, 1565, 1590, 1690, 1850, 1860, 1890 & 1990 drills.
- Replaces OEM # AA38447, AN280966, AN281359
- 3.8 lbs.



CLOSING WHEEL

Order # K213060

\$46¹⁰ ea.

- Cast iron closing wheel to fit late models 750 & 1850
- Replaces OEM # AN213060
- 18.4 lbs.



BEARING

Order # K8535

\$4⁷⁵ ea.

- CAST IRON closing wheel bearing
- To fit John Deere® models 750, 1850 no till drills
- Replaces OEM #AN8535/AA61722
- .15 lbs.



SEAL

Order # K213072

\$5²⁵ ea.

- For K213060 and early 750 with updated wheels
- Replaces OEM # AN213072
- .04 lbs.



CLOSING WHEEL

Order # K282110

\$29⁰⁰ ea.

- To fit models 1560, 1590, 1690, 1860, 1890, 1895 & 1990
- Replaces OEM # N282110
- 15.1 lbs.



HUB

Order # K281856

\$54³⁵ ea.

- Hub with bearing to fit 1560, 1590, 1690, 1835, 1860, 1890, 1895 & 1900CCS
- Replaces OEM # AN281856/N283291
- 4.2 lbs.



SPRING

Order # K282218 (RH)
Order # K282219 (LH)

\$13⁸⁰ ea.

- Torsion spring for rubber press wheel
- To fit models 1560,1860,1690,1890,1895,1590 & 1990
- Replaces OEM # N282218, N282219
- Right hand shown
- 1.3 lbs.



Order online at WWW.KOOIMA.COM and receive FREE FREIGHT to your door!

KOOIMA
COMPANY



205

Kooima® Replacement No-Till Drill Parts

Check out these Grain Drill/Air Drill seeder parts now available!

DEPTH SHAFT
Order # K282117

\$39⁷⁵ ea.

- To fit models 1560, 1565, 1690, 1835, 1860, 1890, 1895, 1590, 1990
- Replaces OEM # AA92485/AN282117/AA73951
- 3.1 lbs.



SPINDLE
Order # K282118 (RH)
Order # K282119 (LH)

\$28³⁰ ea.

- Gauge wheel arm spindle on models 1560, 1565, 1590, 1690, 1835, 1860, 1890, 1895, 1590, 1990
- Replaces OEM # AN282118, AN282119
- Right hand shown • 1 lb.



SEAL
Order # K281241

\$8⁷⁵ ea.

- Hub seal rear, triple lip 3"/16" O.D on models 1560, 1565, 1860, 1690, 1890, 1895, 1590, 1990
- Replaces OEM # AN281241 • .07 lbs.



INNER BUSHING
Order # K280648

\$9⁷⁵ ea.

- For closing wheel arm on models 750, 6001 & up, 1560, 1590, 1690, 1850, 1860, 1890, 1895, 1990
- Replaces OEM # N280648 • .4 lbs.



PIVOT PIN
Order # K282536

\$22⁰⁰ ea.

- Inner or upper for opener arm on models 1560, 1565, 1860, 1890, 1895, 1590, 1990
- Replaces OEM # N282536 • 1.8 lbs.



OUTER BUSHING
Order # K219547

\$3⁷⁵ ea.

- Outer bushing for closing wheel and press wheel arm to fit models 750, SN. 3835 & up, 1560, 1590, 1690, 1835, 1850, 1860, 1890, 1895, 1990.
- Replaces OEM # N219547 • .12 lbs.



BEARING KIT
Order # K44267

\$19³⁰ ea.

- For 750 grain drill and 1850 air seeder blade
- Contains bearings, cups, seals and retainer
- .7 lbs.



GAUGE WHEEL ARM
Order # K282374

\$58³⁵ ea.

- To fit models 750 & 1850
- Replaces OEM # AN282374
- 1.9 lbs.



OPENER SPINDLE
Order # K280725

\$65⁴⁵ ea.

- To fit models 750 & 1850
- With depth adjustment plate
- Replaces OEM # AN280725 • 2.9 lbs.



SPRING
Order # K283994 (RH)
Order # K283995 (LH)

\$8¹⁵ ea.

- Torsion spring for cast closing wheel • 1.56 lbs.
- To fit models 1560, 1590, 1690, 1860, 1690, 1890, 1895 & 1990
- Replaces OEM # N283994, N283995, N282888, N282889
- Right hand shown





KOOIMA® REPLACEMENT BATTERY BOXES TO FIT JOHN DEERE® 10 and 20 Series

- Replaces rusted & corroded boxes
- Powder coat finish
- 20% heavier construction
- Laser cut to OEM specification
- Mounting brackets included
- Made in the USA
- 12.4 lbs. ea.

Order # JD4020BL (left)

Order # JD4020BR (right)

Only \$87⁰⁰ ea.

Check out our Newly Redesigned website!

www.kooima.com



24/7 access to order!



Free shipping on retail web orders in the Continental U.S.!

(Some exclusions apply)



Watch videos of our products!



THE DIRECT ADVANTAGE

The Traditional Way



HEAD CART



This SPFH friendly head cart will keep your expensive chopping and hay heads off the ground, while you enjoy the benefits of easy loading and unloading using your existing chopper. The 9000 lb. rated capacity and 15' base accommodate a large range of heads.

US Patent: 8,919,800

Order # KHC15

Call For Pricing

Optional Hitch Pin /
Clevis Connection

Order # FH5001013

\$100⁷⁵ ea. 8.35 lbs.





COMBINE PARTS PRODUCT INDEX

● AC [®] -Gleaner [®] Combines (replacement parts to fit)	210 ●
● Capello [®] Corn Heads	210 ●
● Case IH [®] Combines (replacement parts to fit)	211-213 ●
● Drago [™] Corn Heads (replacement parts to fit)	214 ●
● Fantini [™] Corn Heads (replacement parts to fit).....	214 ●
● Geringhoff [®] Rota Disc (replacement parts to fit)	214 ●
● Harvestec [™] (replacement parts to fit)	215 ●
● John Deere [®] Combines (replacement parts to fit).....	215-217 ●
● Lexion [®] CAT [®] Rota Disc (replacement parts to fit).....	217 ●
● Massey Ferguson [®] Combines (replacement parts to fit)	218 ●
● New Holland [®] Combines (replacement parts to fit).....	218-219 ●
● New Idea [®] Combines (replacement parts to fit).....	220 ●
● White [™] Combines (replacement parts to fit).....	220 ●
● Oliver [®] -White [™] Combines (replacement parts to fit)	220 ●

For over 25 years Kooima[®] Company has been manufacturing replacement forage harvester parts, combine parts, mixer knives, header adapters and more! We are an independent manufacturer of replacement parts, because of this we are able to produce quality parts at competitive prices.

Kooima[®] Company

2638 310th Street, Hwy. 18 East • P.O. Box 156 • Rock Valley, Iowa 51247

1-800-522-8874 • 712-476-5600 • Fax 712-476-6283 • www.kooima.com

Capello[®] is a registered trademark of CAPELLO S.R.L. • Geringhoff[®] is a registered trademark of Carl Geringhoff GmbH & Co. KG. • Gleaner[®], New Idea[®], Hesston[®], AC[®], Massey Ferguson[®] and Oliver[®] are registered trademarks of AGCO Corporation • White[™] and Field Queen[™] are trademarks of AGCO Corporation • Allis-Chalmers[™] is a trademark of Allis-Chalmers Corporation. • Case[®], Case IH[®] and New Holland[®] are registered trademarks of CNH Industrial America, LLC • NH[™] is a trademark of CNH America, LLC • Claas[®] and Lexion[®] are registered trademarks of Claas KGaA, MBH • CAT[®] is a registered trademark of CATERPILLAR INC. • Cressoni[™] is a trademark of F.lli CRESSONI s.p.a • Fantini[™] is a trademark of Fantini S.r.l. • John Deere[®] and JD[®] are registered trademarks of Deere & Company • Drago[™] and DragoTec[™] are trademarks of Dragotec USA • Lazert[™] is a trademark of Kooima[®] Company, Inc. • Koyma Klad[®], Kooima[®] Company and the Kooima[®] starburst logo are registered trademarks of Kooima[®] Company, Inc.

KOOIMA® REPLACEMENT PARTS TO FIT AC®-GLENER®

AC® and Gleaner® are registered trademarks of AGCO Corporation, which does not manufacture, distribute or endorse these parts.

Kooima® Replacement Parts To Fit AC®-GLENER® CORN HEADS

KOOIMA #	DESCRIPTION	REPLACES OEM #
KAC100 \$16.80 ea.	 <ul style="list-style-type: none"> Snapping roll flute To fit 1972 - 1976 orange low-profile quick tach To fit 1977 - present black adjustable row heads 4 required per roll 	70586591 Heat Treated 3 lbs.

KHC110 \$17.25 ea.	 <ul style="list-style-type: none"> Snapping roll flute To fit 1988 and later Huger corn heads 3 required per roll 	71351081 Heat Treated 2.2 lbs.
------------------------------	--	---

Kooima® Replacement Parts To Fit AC®-GLENER® STRAW CHOPPERS

SCKK100 \$18.10 per kit	 <ul style="list-style-type: none"> Straw chopper knife kit Our most popular kit! Kit includes: (3) knives (3) bushings (3) bolts (3) lock nuts 	71310275 Heat Treated 2.5 lbs./kit
-----------------------------------	---	---

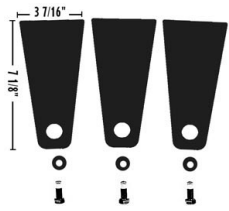

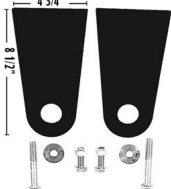

SCKKHES \$8.50 per kit	 <ul style="list-style-type: none"> Straw chopper knife kit To fit AC®/Gleaner® F & K to SN. 36000 & all model G To fit White™ models 7800 & 8800 to SN. 74000 Kit includes: (3) knives (3) bushings (3) bolts (3) lock nuts 	71355851 71310274 31-7536360 Heat Treated 2.3 lbs./kit
----------------------------------	---	---

SCKKACG \$14.25 per kit	 <ul style="list-style-type: none"> Straw chopper knife kit To fit all Gleaner® N & R series models Kit includes: (2) knives (2) bushings (2) bolts (2) lock nuts 	71376992 71355851 Heat Treated 3.1 lbs./kit
-----------------------------------	--	---

SCTK110 \$6.50 per kit	 <ul style="list-style-type: none"> Stationary chopper knife To fit many popular machines Kit includes: (1) tooth (1) bolt (1) lock washer (1) hex nut 	71174897 Heat Treated .6 lbs./kit
----------------------------------	--	--

KOOIMA® REPLACEMENT PARTS TO FIT CAPELLO® COMBINE EQUIPMENT

Capello® is a registered trademark of CAPELLO S.R.L., which does not manufacture, distribute or endorse these parts.

KOOIMA #	DESCRIPTION	REPLACES OEM #
K03201900 \$32.35 ea.	 <ul style="list-style-type: none"> Replacement stalk roll knife • 2.7 lbs. To fit Capello® corn heads Bolt Kit: K03201900BK, \$6.75 ea., 1 kit per blade 	WN-M1-80022 Heat Treated Tungsten Carbide
K3199900 \$27.25 ea.	 <ul style="list-style-type: none"> 20" row spacing stalk chopper knife • 1.1 lbs. To fit Capello® Quasar corn heads 	WN-03199900 Heat Treated/ Tungsten Carbide
K3202100 \$25.65 ea.	 <ul style="list-style-type: none"> 22" row spacing stalk chopper knife • 1.3 lbs. To fit Capello® Quasar corn heads 	WN-03202100 Heat Treated/ Tungsten Carbide
K3202101 \$25.65 ea.	 <ul style="list-style-type: none"> 30" row spacing stalk chopper knife • 1.45 lbs. To fit Capello® Quasar corn heads 	WN-03202101 Heat Treated/ Tungsten Carbide
K80126 \$3.75 ea.	 <ul style="list-style-type: none"> Stalk chopper knife bushing • .05 lbs. Used with K3199900, K3202100 & K3202101 knives 	WN-M1-80126 Heat Treated

KOOIMA® REPLACEMENT PARTS TO FIT CASE IH® CORN HEADS AND STRAW CHOPPERS

Case® and Case IH® are registered trademarks of CNH Industrial America, LLC, which does not manufacture, distribute or endorse these parts.

KOOIMA #	DESCRIPTION	REPLACES OEM #
K800 \$13.35 ea.	 • Snapping roll knife • To fit all 800 series heads • 4 required per roll • 2.2 lbs.	176304C2 Heat Treated Tungsten Carbide
K900 \$12.35 ea.	 • Snapping roll knife • To fit all 900 & 1000 series heads • 4 required per roll • 2 lbs.	1327126C1 Heat Treated Tungsten Carbide
K800900BK \$0.65 ea.	 • 1/2" x 1" grade 8 bolt • To fit all 800 & 900 series blades • .1 lbs.	
K176301 \$16.30 ea.	 • Snapping roll driver • To fit all 800, 900 & 1000 series heads • 1 required per roll • 1.6 lbs.	176301C2
KD800L (Left) KD800R (Right) \$14.00 ea.	 • Deck plate • To fit all 800 series heads • Left hand shown • 8.2 lbs. ea.	176291C91 176292C91 Abrasion Resistant
KD1000L (Left) KD1000R (Right) \$16.00 ea.	 • Deck plate • To fit all 900 & 1000 series heads • Left hand shown • 6.4 lbs. ea.	199381C2 199382C2 Abrasion Resistant
K176280 \$18.00 ea.	 • Gathering chain guide • To fit all 800 series heads • 2 required per row • 2.8 lbs.	176280C1
K1347176 \$16.80 ea.	 • Gathering chain guide • To fit all 900 & 1000 series heads • 2 required per roll • 2.9 lbs.	1347176C1
K1306079C1 \$17.95 ea.	 • Rear stalk roll weed knife • 1 required per row • To fit Case IH® 1000 series corn heads • 1.55 lbs. • K1306079BK - Bolt kit, 1 required per knife, .15 lbs. - \$3.75 ea.	1306079C1 Heat Treated
K1306823 (Left) K1306824 (Right) \$14.55 ea.	 • Row unit side knife • To fit Case IH® 1000 series corn heads • Left hand shown	1306823C1 1306824C1 Heat Treated
K86977538 \$42.35 ea.	 • Snapping roll knife • To fit all 2200 & 2400 series corn heads • 2 required per snapping roll • 2.6 lbs. • K86977538BK - Bolt kit, 1 bolt kit does two knives - \$25.90 ea.	86977538 Heat Treated Tungsten Carbide
K87047540 (Left) K86978032 (Right) \$23.75 ea.	 • Deck plate • To fit all 2200 & 2400 series corn heads • Left hand shown • 9.8 lbs. ea.	87047540 Abrasion Resistant
K87047608 \$39.75 ea.	 • Deck plate for hydraulic row heads • To fit all 2200 & 2400 series corn heads • 13.1 lbs.	87047608 Abrasion Resistant
K86596059 \$24.80 ea.	 • Left side chain guide • 3.75 lbs. • Use with adjustable deck plates • Fits Case IH® 2200, 2400, 3200, 3400 & New Holland® 96C and 98C Corn heads	86596059/87108785 87108786/87108787 87108783/86579976 86596058
K86611426 \$30.85 ea.	 • Chain guide • 4.1 lbs. • To fit Case IH® 2200 & 2400 with manual deck plate or RH only with hydraulic deck plates • NH® 974 serial # 536455 and above, 996, 96C, & 98C with manual deck plates and RH only w/ hyd. deck plates	86611426/86579975 86611425/89825690
K322591950 \$22.50 ea.	 • Stalk roll knife • To fit 2600 series Case IH® corn heads • 3.1 lbs.	322591950
K84976065 \$15.25 ea.	 • Stalk chopper knife • To fit 2600 series Case IH® corn heads • 1.25 lbs.	84340041 84976065

Replacement parts produced by Kooima® Company to fit Case IH®

Order online at WWW.KOOIMA.COM and receive **FREE FREIGHT** to your door!

KOOIMA
COMPANY











KOOIMA® REPLACEMENT PARTS TO FIT CASE IH® CORN HEADS AND STRAW CHOPPERS

Replacement parts produced by Kooima® Company to fit Case IH®

KOOIMA #	DESCRIPTION	REPLACES OEM #
K87598741 \$20.60 ea.	 • Stalk roll knife • To fit 3000 series Case IH® corn heads • 2.1 lbs.	87598741
K87725510 (Left) K87725511 (Right) \$10.00 ea.	 • Row unit side knives • To fit 3000 series Case IH® corn heads • Left hand shown • .85 lbs.	87725510 87725511
K84410193 \$64.95 ea.	 • Left hand flat deck plate • To fit 3200-3400 series corn heads • 11.5 lbs.	84410193/84255207/84416205 87593314/84471412
K84410217 \$63.45 ea.	 • Right hand flat deck plate • To fit 3200-3400 series • 11.3 lbs. • K84410217BK : \$2.15 ea. 1 required/deck plate	84410217/84255205/ 84416205 87593314/84471412
K84417359 \$60.45 ea.	 • Row unit scraper • 1.5 lbs. • To fit Case IH® 3000 series corn heads • 1 required per row • K80700 : Washer used with K84417359 • 2 required per scraper • \$0.45 ea.	84417359/47723637 80700
K87641987 \$18.80 ea.	 • Extendable stalk guide for the upper deck on 3000 series corn heads • 1.5 lbs.	87641987
K87593362 \$55.35 ea.	 • Right hand chain guide • 3.7 lbs. • To fit Case IH® 3200, 3400 & New Holland® 98D series corn heads	87593362/84416209/84416204/87617050 84416205/84471412/84471411 87593314/87593314E/87607076
K84316263 \$66.45 ea.	 • Left hand chain guide • 3.9 lbs. • To fit Case IH® 3200, 3400 & New Holland® 98D series corn heads	84316263/87593361/84416204/84416209 84416205/84471411/84471412/87593314E 87593314/87593361/8760706/87617050
K84499693 \$23.15 ea.	 • Stalk roll knife • 3.15 lbs. • To fit Case IH® 4400 series • 8 required per row	84499693
SCKKIH \$22.15 per kit	 • Straw chopper knife kit • To fit 715, 815, 915, 1420, 1440, 1460, 1480, 1620, 1640, 1660, 1680, 1644, 1666, 1688, 2144, 2166, 2188, 2344, 2366 & 2388 • Kit includes: (2) hammers, (4) bolts, (4) nuts	442832A1 197124C1 Heat Treated Tungsten Carbide 2.2 lbs./kit
K442832 \$29.80 per kit	 • Milled straw chopper knife kit • To fit 715, 815, 915, 1420, 1440, 1460, 1480, 1620, 1640, 1660, 1680, 1644, 1666, 1688, 2144, 2166, 2188, 2344, 2366, 2388 & 5130-7130 • Kit includes: (2) hammers, (4) bolts, (4) nuts	442832A1 Heat Treated Tungsten Carbide 2.1 lbs./kit
K442832B \$10.75	 • Milled straw chopper blade • Individual blade • .8 lbs. • Order in any qty.	409731A1 Heat Treated Tungsten Carbide
K87280494 \$17.90 ea.	 • Milled-offset chopper blade • .8 lbs. • To fit 7010 / 8010 - 7120 / 8120 / 9120 • Sold individually	87280494 Heat Treated Tungsten Carbide
K87280494BK \$2.15 ea.	 • Bolt Kit to fit K87280494 Blade • 1 Kit required per blade • .3 lbs.	87030508 86512497
K87106692 \$4.25 ea.	 • Fine cut knife section • .27 lbs. • To fit 7010 / 8010 - 7120 / 8120 / 9120	87106692 Heat Treated
K102009 \$34.50 ea.	 • Gathering chain - 8 lug • 9.5 lbs. • To fit 800 series, 900 series, 1043, 1044, 1054, 1063, 1083, 1084, 2206, 2208, 2212, 2406, 2408, 2412, 3206* (2011 & Later), 3208* (2001 & Later), 3212, 3406, 3408, 3412, 3416	AN102009/610831/176279C91

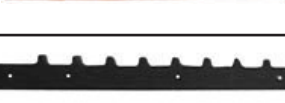

KOOIMA® REPLACEMENT PARTS TO FIT CASE IH® CORN HEADS AND STRAW CHOPPERS

Replacement parts produced by Kooima® Company to fit Case IH®

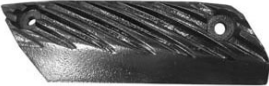

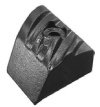

KOOIMA #	DESCRIPTION	REPLACES OEM #
K385877 \$25.60 ea. 	<ul style="list-style-type: none"> Replacement stalk chopper knife To fit Cressoni™, Case IH®, Drago™, and New Holland® heads 	Heat Treated Tungsten Carbide 1.8 lbs.
K385877B \$6.25 ea. 	<ul style="list-style-type: none"> Stalk chopper knife bushing to fit Kooima® chopper knife (K385877) To fit Cressoni™, Fantini™, Case IH®, Drago™ and New Holland® 	Heat Treated .1 lbs.
K385877RD \$6.25 ea. 	<ul style="list-style-type: none"> Stalk chopper knife bushing with round hole to fit Kooima® chopper knife (K385877) To fit Cressoni™, Fantini™, Case IH®, Drago™ and New Holland® 	Heat Treated .1 lbs.
KWB1440 \$31.85 ea. 	<ul style="list-style-type: none"> Wear bars • 3 required To fit 1440, 1460, 1640, 1660, 1644, 1666, 2144, 2166, 2344 & 2366 Sold per piece • KWB1440BK- Bolt kit, \$3.75 ea., .85 lbs. 	183253C4 14.8 lbs.
KWB1480 \$37.75 ea. 	<ul style="list-style-type: none"> Wear bars • 2 required To fit 1480, 1680, 1688, 2188 & 2388 Sold per piece • KWB1440BK- Bolt kit, \$3.75 ea. 	1309186C3 14.2 lbs.
KE1440 \$144.75 ea. 	<ul style="list-style-type: none"> Elephant ears • 3 required To fit 1440, 1460, 1640, 1660, 1644, 1666, 2144, 2166, 2344 & 2366 Sold per piece • KE1480BK- Bolt kit, \$3.75 ea., .5 lbs. 	1957446C3 23.6 lbs.
KE1480 \$143.75 ea. 	<ul style="list-style-type: none"> Elephant ears • To fit 1480, 1680, 1688, 2188 & 2388 Sold per piece • 2 required KE1480BK- Bolt kit, \$3.75 ea., .5 lbs. 	1957445C3 32 lbs.
K1302103 \$30.35 ea. 	<ul style="list-style-type: none"> Tooth bar • Used as required • 6 lbs. To fit all Case IH® rotary combines 	1302103C3 Abrasion Resistant

KOOIMA #	MODEL APPLICATION	BAR TYPE & PARTICULARS	REPLACES OEM #
K1308829 (Helical) \$10.00 ea.	1440, 1460, 1470, 1640	12 Helical & 9 flat	1308829C2
K1308668 (Flat) \$10.25 ea. 	1660, 1644, 1666, 2144, 2166, 2344, 2366	Standard 6 row soy bean rotor - 95 lbs./set	1308668C1

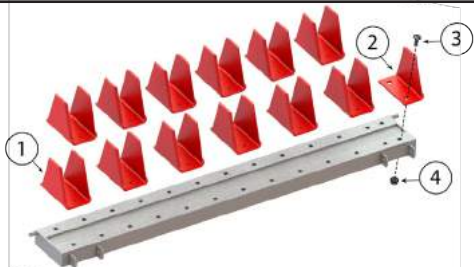
K130BK \$2.65 ea. Cylinder bar bolt kit - 1 kit required per bar • .15 lbs

KR2 \$13.25 ea. 	Rotary-Specialty	Less spike, corn/bean rotor 1640-2366 required 54 bars 1680-2388 required 72bars	84164540 Heat Treated 2.25 lbs
KR2HP \$16.30 ea. 	Rotary-Specialty	Less spike, corn/bean rotor 1640-2366 required 54 bars 1680-2388 required 72 bars Koyma Klad® extended life wear coating applied	84164540 2.25 lbs Heat Treated
KR2BK \$1.85 ea. Bolt kit to fit part #KR2 & KR2HP - 1 kit required per bar • .25 lbs.			87302717 / 186852C1









KOOIMA #	DESCRIPTION	REPLACES OEM #
K87315088 \$9.75 ea. 	<ul style="list-style-type: none"> Square hole style stationary chopper knife • 12 required • .55 lbs. To fit Axial Flow Combines 2377, 2388, 2399, 2577, 2588, 5088, 6088, 7088 	87315088 Heat Treated
K396960 \$12.15 ea. 	<ul style="list-style-type: none"> Round hold style stationary chopper knife • 12 required • .55 lbs. To fit Axial Flow Combines 2377, 2388, 2399, 2577, 2588, 5088, 6088, 7088 	396960A1 Heat Treated
K87315089 \$8.75 ea. 	<ul style="list-style-type: none"> Stationary chopper knife end • 1 required • .35 lbs. To fit Axial Flow Combines 2377, 2388, 2399, 2577, 2588, 5088, 6088, 7088 	87315089 Heat Treated
K280638 \$0.40 ea. 	<ul style="list-style-type: none"> Carriage bolt • .015 lbs. 1/4 - 20 x 3/4 • 26 required 	280638
K2315344 \$0.40 ea. 	<ul style="list-style-type: none"> Flange nut • .01 lbs. 1/4 - 20 • 26 required 	

Podemos tomar órdenes en español! : 1-800-522-8874 • By fax: 712-476-6283 • Online: www.kooima.com

KOOIMA® REPLACEMENT PARTS TO FIT DRAGO™ COMBINE EQUIPMENT

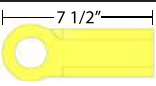
Drago™ is a trademark of Dragotec USA, which does not manufacture, distribute or endorse these parts.

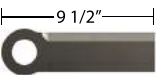

Replacement parts produced by Kooima® Company to fit Drago™

KOOIMA #	DESCRIPTION	REPLACES OEM #
K11030 \$37.00 ea.	 <ul style="list-style-type: none"> • Replacement stalk roll knife • 2.4 lbs. • To fit Drago™ corn heads • 4 required per roll • Bolt kit: K11030BK, \$8.00 - 1 kit does 2 knives 	DR-11030 Heat Treated Tungsten Carbide
K385877 \$25.60 ea.	 <ul style="list-style-type: none"> • Replacement stalk chopper knife • 2 used per roll • 1.8 lbs. 	DR-12300 Heat Treated Tungsten Carbide
K385877B \$6.25 ea.	 <ul style="list-style-type: none"> • Stalk chopper knife bushing • .1 lbs. • Use with K385877 stalk chopper knife 	DR-12310 Heat Treated
K12330 \$0.80 ea.	<ul style="list-style-type: none"> • Stalk chopper knife bolt • 1 required per blade 	DR-11070
K0052 \$25.80 ea.	 <ul style="list-style-type: none"> • 7 1/2 Stalk chopper knife • 1 lb. • To fit Drago™ corn heads • 2 required 	1AC0052BM1 Heat Treated/ Tungsten Carbide
K0051 \$25.80 ea.	 <ul style="list-style-type: none"> • 8 1/2 Stalk chopper knife • 1.1 lbs. • To fit Drago™ corn heads • 2 required 	1AC0051BM1 Heat Treated/ Tungsten Carbide
K0050 \$26.20 ea.	 <ul style="list-style-type: none"> • 9 1/2 Stalk chopper knife • 1 lb. • To fit Drago™ corn heads • 2 required 	1AC0050BM1 Heat Treated/ Tungsten Carbide
K9090 (LH) K9100 (RH) \$55.83 ea.	 <ul style="list-style-type: none"> • Deck plate • To fit Drago™ corn heads • Left hand shown • 4.7 lbs. 	DR-9090 DR-9100

KOOIMA® REPLACEMENT PARTS TO FIT FANTINI™ COMBINE EQUIPMENT

Fantini™ is a trademark of Fantini S.r.l., which does not manufacture, distribute or endorse these parts.

Replacement parts produced by Kooima® Company to fit Fantini®

KOOIMA #	DESCRIPTION	REPLACES OEM #
K12133 \$25.00 ea.	 <ul style="list-style-type: none"> • Replacement stalk roll knife • To fit Fantini™ corn heads • 2.9 lbs. 	12133 Heat Treated Tungsten Carbide
K13741 \$26.00 ea.	 <ul style="list-style-type: none"> • Replacement stalk chopper knife • To fit Fantini™ corn heads • 1.8 lbs. • Uses K385877RD bushing, \$6.25 ea. 	Heat Treated Tungsten Carbide

KOOIMA® REPLACEMENT PARTS TO FIT GERINGHOFF® COMBINE EQUIPMENT

Geringhoff® is a registered trademark of Carl Geringhoff GmbH & Co. KG, which does not manufacture, distribute or endorse these parts.





Replacement parts produced by Kooima® Company to fit Geringhoff®

KOOIMA #	DESCRIPTION	REPLACES OEM #
K501060 \$27.50 ea.	 <ul style="list-style-type: none"> • Replacement knife • To fit Geringhoff® Rota Disc cutting system • .45 lbs. 	501060 Heat Treated Tungsten Carbide
K502351 \$31.00 ea.	 <ul style="list-style-type: none"> • Replacement knife • 2.4 lbs. • To fit Geringhoff® North Star corn heads 	502351 Heat Treated/ Tungsten Carbide

Bolt kit - K502351BK, \$1.90 - 6 kits required per snapping roll, each kit includes 1 bolt, 1 washer & 1 jam nut

KOOIMA® REPLACEMENT PARTS TO FIT HARVESTEC™ COMBINE EQUIPMENT











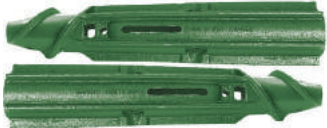



Harvestec™ is a trademark of Linamar Agriculture Inc., which does not manufacture, distribute or endorse these parts.

KOOIMA #	DESCRIPTION	REPLACES OEM #
K1356304 \$53.85 ea.	 • Snapping roll knife • 2 1/2" x 21 7/8" • 3.2 lbs. • To fit 5000 series 2004 & above • 4 required	Heat Treated Tungsten Carbide
K1356304BK \$2.15 ea.	 • Bolt kit • For K1356304 • 1 required per knife • .5 lbs.	
K1353038 \$31.85 ea.	 • Stalk chopping knife • To fit 5000 series 2004 & newer • Long style knife • 1.3 lbs.	Heat Treated Tungsten Carbide
K1353038BK \$6.00 ea.	 • Bolt kit • .5 lbs. • For K1353038 • Kit includes: 1 bolt, 1 nut, 1 lock pin	
K1319890 \$9.75 ea.	 • Bushing • .095 lbs. • To fit 5000 series 2004 & newer	

Replacement parts produced by Kooima® Company to fit Harvestec™

KOOIMA® REPLACEMENT PARTS TO FIT JOHN DEERE® CORN HEADS

John Deere® and JD® are registered trademarks of Deere & Company, which does not manufacture, distribute or endorse these parts.















KOOIMA #	DESCRIPTION	REPLACES OEM #
K104090 (Right) K104091 (Left) \$82.95 ea.	 • Snapping roll • 18.5 lbs. ea. • To fit all 40 series heads • 1 right & 1 left required per row	H104090 H104091 Hard Faced Weld
K34H334 \$0.70 ea.	 • 5/16" x 2" spring pin for snapping roll heads • To fit all 40 & 90 series heads • .1 lbs. • 1 per roll	34H334
K149591 \$0.95 ea.	 • Pin fastener for snapping roll heads • To fit all 40 & 90 series heads • .1 lbs. • 1 per roll	H149591
K19M7361 \$1.50 ea.	 • M12 x 50, straight fluted • .1 lbs. • To fit 90 series heads • 2 per roll	19M7361
K19H2735 \$2.25 ea.	 • 1/2" x 2", tapered • .15 lbs. • To fit 40 series heads • 2 per roll	19H2735
K143881 \$79.95 ea.	 • Snapping roll shaft • 7.2 lbs. • To fit 40-90 series heads	AH143881 AN102001
K102009 \$34.50 ea.	 • Gathering chain - 8 lug • 9.5 lbs. • To fit 40 & 90 series corn heads	AN102009 610831 / 176279C91
K102448 \$11.75 ea.	 • Lower idler sprocket, early • Sealed bearing • 8 tooth • To fit 40 series heads up to SN. 466450 • 1.5 lbs.	AN102448
K101219 \$12.50 ea.	 • Lower idler sprocket, late • Relube bearing • 8 tooth • 1.4 lbs. • To fit 40 series heads after SN. 466451 and all 90 series heads	AH101219
K85252 \$17.30 ea.	 • Upper drive sprocket • 2.4 lbs. • 8 tooth - hex bore • To fit 40 & 90 series heads	H85252 / 102009 / CA55548C6EP Heat Treated
KJD068 (Right) KJD069 (Left) \$13.30 ea.	 • Deck plate • 9.1 lbs. ea. • To fit 40 series heads up to SN. 466450	N102068 N102069
KJD952 \$18.00 ea.	 • Deck plate, right or left • To fit 40 series heads SN. 466451 & up • 7.3 lbs.	H94952 Abrasion Resistant
K202233 \$17.50 ea.	 • Gathering chain guide • 3.7 lbs. • To fit 40 series heads	H118945 Abrasion Resistant
K146158 \$21.80 ea.	 • Chain guide, cast iron • 8 lbs. • To fit all 90 series heads • K146158BK - Bolt kit, \$2.90 ea.	H151211 H146158

Replacement parts produced by Kooima® Company to fit John Deere®

Order online at WWW.KOOIMA.COM and receive **FREE FREIGHT** to your door!

KOOIMA® REPLACEMENT PARTS TO FIT JOHN DEERE®





Replacement parts produced by Kooima® Company to fit John Deere®

K150138 (Right) K150139 (Left) \$95.90 ea.		<ul style="list-style-type: none"> • Snapping roll • 24.3 lbs. ea. • To fit 90 series heads with straight cast rolls • 1 right & 1 left required per roll 	H150138 H150139 Hard Faced Weld
K154270 \$29.30 ea.		<ul style="list-style-type: none"> • Deck plate • 2 required per row • 9.3 lbs. • Hard surfaced edged • To fit 90 series heads 	H154270 Hard Faced Weld
K147773 \$82.95 ea.		<ul style="list-style-type: none"> • Left hand deck plate • 1 per row • Hard surfaced edged • 11 lbs. • To fit 90 series heads with hydraulic adjust 	AH147773 Hard Faced Weld
K237437 \$43.00 ea.		<ul style="list-style-type: none"> • Right hand deck plate • 1 per row • 5.75 lbs. • Hard faced edge • To fit JD® 606, 608 and 612 corn heads serial # 745101 and above 	H237437 Hard Faced Weld
K234656 \$63.00 ea.		<ul style="list-style-type: none"> • Left hand deck plate • 1 per row • 6.9 lbs. • Hard faced edge • To fit JD® 606, 608 and 612 corn heads serial # 745101 and above 	AH234656 Hard Faced Weld
K225719 \$50.35 ea.		<ul style="list-style-type: none"> • Right hand deck plate • 1 per row • 6.75 lbs. • Hard faced edge • To fit JD® 606, 608 and 612 corn heads serial # 745100 and below 	H225719 Hard Faced Weld
K232250 \$76.45 ea.		<ul style="list-style-type: none"> • Left hand deck plate • 1 per row • 9.25 lbs. • Hard faced edge • To fit JD® 606, 608 and 612 corn heads serial # 745100 and below 	AH232250 Hard Faced Weld
K119746 \$490.00 ea.		<ul style="list-style-type: none"> • Drive shaft • 21 spline to 1 1/8" hex • Replacement shaft for 90 series Side Hill corn heads • 33" collapsed length • 29.5 lbs. 	AH119746
K215212 \$4.50 ea.		<ul style="list-style-type: none"> • Bushing for AH225940 blade • 2 bushings required per blade • .1lb. 	H215212 Heat Treated
K225940BK \$4.45 ea.		<ul style="list-style-type: none"> • Bolt kit for AH225940 blade • 1 kit required per blade • Each kit contains: 1 bolt, 2 washers & 1 lock nut 	19M7935/ H156101/A51212
K225937BK \$7.00 ea.		<ul style="list-style-type: none"> • Bolt kit for H218169 & H218170 blade • 1 kit req. per blade set • Each kit contains 1 bolt, 2 washers & 1 lock nut 	19M7499/H156101/A51212
K218499 \$11.25 ea.		<ul style="list-style-type: none"> • Bushing for H218169 & H218170 blade • 1 required per blade 	H218499 Heat Treated
K205908 (RH) K205907 (LH) \$12.25 ea		<ul style="list-style-type: none"> • Straw chopper blade • .65 lb. • To fit 9500, 9500SH, 9510, 9510SH, 9550, 9550SH, 9560, 9560SH, 9560STS, 9600, 9610, 9650, 9650CTS, 9650STS, 9660, 9660CTS, 9660STS, 9750STS, 9760STS, 9860STS, CTS, CTS II Combines 	AH205909 Heat Treated Tungsten Hard Faced
K167127 \$6.50 ea.		<ul style="list-style-type: none"> • Bushing for K205908 & K205907 blade • .18 lb. 	H167127 / H173055 Heat Treated

Kooima® Replacement Parts To Fit JOHN DEERE® STALK CHOPPER KNIFE

KOOIMA #	DESCRIPTION	REPLACES OEM #
K36504 \$15.50 ea.	<ul style="list-style-type: none"> • Stalk chopping knife • 1.6 lbs. • To fit JD® 606-612 (after serial # 745101) 616, 618 corn heads 	HXE36504 Heat Treated Tungsten Carbide
K24237 \$9.50 ea.	<ul style="list-style-type: none"> • Stalk chopping knife bushing • .15 lbs. • To fit JD® 606-612 (after serial # 745101) 616, 618 corn heads 	HXE24237 Heat Treated

Kooima® Replacement Parts To Fit JOHN DEERE® 50 & 50A SERIES ROW CROP HEADS

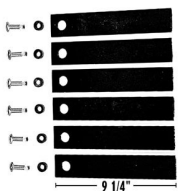
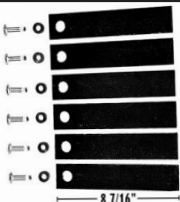
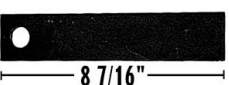
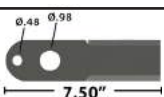
KOOIMA #	DESCRIPTION	REPLACES OEM #
K139066 \$29.30 ea.	 • Stationary knife • 2.8 lbs. • To fit all 50 & 50A series heads • 1 required per row	H139066 Heat Treated Tungsten Carbide
K27079 \$135.00 ea.	 • Gathering belt assembly • To fit John Deere® 50 series row crop bean head • 2 used per row • 12.88 lbs. • Now with improved heavier belting	AE27079 AE73755
K101172 \$150.75 ea.	 • Gathering belt assembly • To fit John Deere® 50A series row crop bean head • 2 used per row • 14.8 lbs. • Now with improved heavier belting	AH101172
SCKKJDC \$20.30 per kit	 • To fit the following machines: • All models 95 (4 kits required) • All models 105 (5 kits required) • Models 3300 (3 kits required), 4400 (4 kits required), 6600 (4 kits required), 7700 (5 kits required), with long shafts • Kit includes 6 knives	H21219 Heat Treated 6.9 lbs./kit
SCKKJDL \$21.80 per kit	 • To fit the following machines: • All models 55 (3 kits required) • All models 4420 (4 kits required) • Models 6620 (4 kits required) • Models 3300 (3 kits required), 4400 (4 kits required), 6600 (4 kits required), with new style drum & bolt-on knife • Kit includes: (6) knives (6) bushings (6) bolts (6) lock nuts	AH126851 Heat Treated 7.1 lbs./kit
SCKKJDS \$22.00 per kit	 • To fit the following machines: • All models 7720 (5 kits required) • All models 8820 (6 kits required) • Models 9400 (5 kits required) 9500 (5 kits required) 9510, 9600, 9610 (6 kits required) • To fit 7700 with new style drum & bolt-on knife (5 kits required) • Kit includes: (6) knives (6) bushings (6) bolts (6) lock nuts	AH124635 Heat Treated 6.6 lbs./kit
SCKKJDSB \$3.75 ea.	 • Straw chopper blade only • Less bushings and hardware • To fit the following machines: • 9400 & 9500 (30 required) • 9510, 9600, 9610 (36 required)	Abrasion Resistant Heat Treated 1 lb. ea.
K142141 \$5.40 ea.	 • Stationary knife • To fit 9000 series combines • Double edged construction	H215004/H142141 Heat Treated .5 lbs.

KOOIMA® REPLACEMENT PARTS TO FIT LEXION® CAT® COMBINE EQUIPMENT

Lexion® is a registered trademark of Claas KGaA, MBH, which does not manufacture, distribute or endorse these parts.

KOOIMA #	DESCRIPTION	REPLACES OEM #
K385877 \$25.60 ea.	 • Drago stalk chopper knife • To fit Cressoni™, Case IH®, Drago™ and New Holland® heads • 1.8 lbs.	Heat Treated Tungsten Carbide
K385877B \$6.25 ea.	 • Stalk chopper knife bushing to fit Kooima® chopper knife (K385877) • To fit Cressoni™, Fantini™, Case IH®, Drago™ and New Holland® • .1 lbs.	Heat Treated
K385877RD \$6.25 ea.	 • Stalk chopper knife bushing w/ round hole to fit Kooima® chopper knife (K385877) • To fit Cressoni™, Fantini™, Case IH®, Drago™ and New Holland® • .1 lbs	Heat Treated
K3531950 \$7.85 ea.	 • Straw chopper knife • To fit Lexion® CAT® 570R • .7 lbs.	353195.0 Heat Treated
K9350680 \$25.30 ea.	 • Replacement stalk roll knife • To fit Lexion® corn heads • 4 required per roll • 2.75 lbs.	Heat Treated Tungsten Carbide
K9350680BKL (Late) K9350680BKE (Early) \$5.25 ea.	 • Bolt kit for K9350680 • To fit late models with poly snout • To fit early models with steel snout • 1 required per knife • .25 lbs.	

TO ORDER CALL TOLL FREE 1-800-522-8874

KOOIMA®
COMPANY



Replacement parts produced by Kooima® Company to fit Lexion® Cat®

KOOIMA® REPLACEMENT PARTS TO FIT MASSEY FERGUSON® CORN HEADS & STRAW CHOPPERS

Massey-Ferguson® is a registered trademark of AGCO Corporation, which does not manufacture, distribute or endorse these parts.

Kooima® Replacement Parts To Fit MASSEY FERGUSON® CORN HEADS

KOOIMA #
KMF45

\$15.30 ea.



DESCRIPTION

- Snapping roll flute
- To fit all Massey Ferguson® heads
- 2 required per roll
- 2.9 lbs.

REPLACES OEM #

264687M2
Heat Treated

Kooima® Replacement Parts To Fit MASSEY FERGUSON® STRAW CHOPPERS

KOOIMA #

SCKK100

\$18.10 per kit

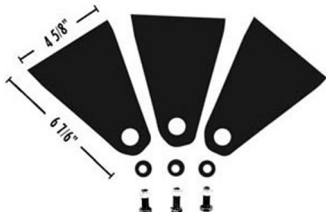

DESCRIPTION

- Straw chopper knife kit • 2.5 lbs./kit
- Our most popular kit!
- Kit includes:
 - (3) knives
 - (3) bushings
 - (3) bolts (3) lock nuts

REPLACES OEM #

837030M91
Heat Treated

SCTK110

\$6.50 per kit



- Stationary chopper knife
- .6 lbs./kit
- To fit many popular machines
- Kit includes:
 - (1) tooth
 - (1) bolt
 - (1) lock washer
 - (1) hex nut

041155M1
Heat Treated

KOOIMA® REPLACEMENT PARTS TO FIT NEW HOLLAND® BALERS

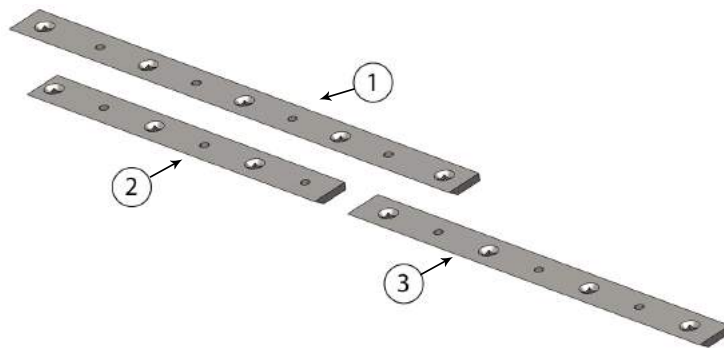

KOOIMA #

K84400465

\$85.45 ea.



DESCRIPTION

- Baler knife • 7.25 lbs.
- To fit models 870S, 870P, 870R, 890S, 890P, 890R, 330S, 330P, 330R

REPLACES OEM #

84400465

Heat Treated

K84814538

\$75.45 ea.



- Right hand baler knife • 4.7 lbs.
- To fit models 1270S, 1270R, 1290S, 1290R, 340S, 340R

84814538

Heat Treated

K84814537

\$80.45 ea.



- Left hand baler knife • 5.75 lbs.
- To fit models 1270S, 1270R, 1290S, 1290R, 340S, 340R

84814537

Heat Treated









Replacement parts produced by Kooima® Company to fit New Holland®

Replacement parts produced by Kooima® Company to fit Massey Ferguson®

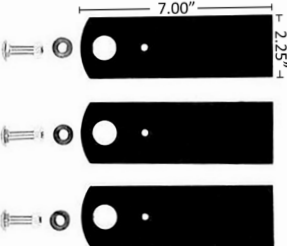
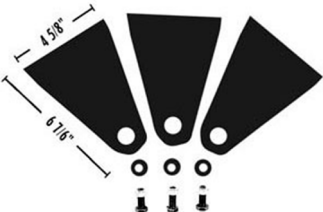
KOOIMA® REPLACEMENT PARTS TO FIT NEW HOLLAND® CORN HEADS & STRAW CHOPPERS

New Holland® is a registered trademark of CNH Industrial America, LLC, which does not manufacture, distribute or endorse these parts.

Replacement parts produced by Kooima® Company to fit New Holland®

KOOIMA #	DESCRIPTION	REPLACES OEM #
KNH300L (Left) KNH300R (Right) 	DESCRIPTION <ul style="list-style-type: none"> • Snapping roll flute • To fit all 962 heads • 4 right & 4 left required per roll • 3.2 lbs. ea. 	703415 703414 Heat Treated
\$10.25 ea.		
KNH9825691 	<ul style="list-style-type: none"> • Deck plate, left or right • To fit all 974 series heads • 2 required per row • 10.6 lbs. 	86611428 9825691
\$20.30 ea.		
SCKKNH 	<ul style="list-style-type: none"> • Chopper knife kit • To fit most late models • Kit includes: <ul style="list-style-type: none"> (3) knives (3) bushings (3) bolts (3) lock nuts • 2.5 lbs./kit 	688331 Heat Treated
\$15.30 per kit		
SCKK100 	<ul style="list-style-type: none"> • Straw chopper knife kit • Our most popular kit! • Kit includes: <ul style="list-style-type: none"> (3) knives (3) bushings (3) bolts (3) lock nuts • 2.5 lbs./kit 	277056 88374 276819 624590 624508 Heat Treated
\$18.10 per kit		
SCKT110 	<ul style="list-style-type: none"> • Stationary chopper knife • To fit many popular machines • Kit includes: <ul style="list-style-type: none"> (1) tooth (1) bolt (1) lock washer (1) hex nut • .6 lbs./kit 	271580 Heat Treated
\$6.50 per kit		
K385877 	<ul style="list-style-type: none"> • Replacement stalk chopper knife • To fit Cressoni™, Case IH®, Drago™ and New Holland® heads • 1.8 lbs. 	Heat Treated Tungsten Carbide
\$25.60 ea.		
K385877B 	<ul style="list-style-type: none"> • Stalk chopper knife bushing to fit Kooima® chopper knife (K385877) • To fit Cressoni™, Fantini™, Case IH®, Drago™ and New Holland® • .1 lbs. 	Heat Treated
\$6.25 ea.		
K385877RD 	<ul style="list-style-type: none"> • Stalk chopper knife bushing with round hole to fit Kooima® chopperknife (K385877) <ul style="list-style-type: none"> • To fit Cressoni™, Fantini™, Case IH®, Drago™ and New Holland® • .1 lbs. 	Heat Treated
\$6.25 ea.		
K102009 	<ul style="list-style-type: none"> • Gathering chain - 8 lug • 9.5 lbs. • To fit 98D, 974 & 996 New Holland® corn heads 	AN102009/610831/176279C91
\$34.50 ea.		



KOOIMA® REPLACEMENT PARTS TO FIT NEW IDEA® CORN HEADS

New Idea® is a registered trademark of AGCO Corporation, which does not manufacture, distribute or endorse this part.

KOOIMA #
K745057

\$10.20 ea.



DESCRIPTION

- Snapping roll flute
- To fit all 800 series heads
- 3 required per roll
- 2.8 lbs.

REPLACES OEM #

745057
Heat Treated

Replacement parts produced by Kooima® Company to fit New Idea®

KOOIMA® REPLACEMENT PARTS TO FIT WHITE™ STRAW CHOPPERS

White™ is a trademark of AGCO Corporation, which does not manufacture, distribute or endorse these parts.

KOOIMA #
SCKK100

\$18.10 per kit

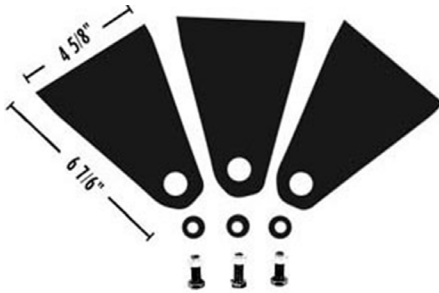

DESCRIPTION

- Straw chopper knife kit
- Our most popular kit!
- Kit includes:
 - (3) knives
 - (3) bushings
 - (3) bolts
 - (3) lock nuts
- 2.5 lbs./kit

REPLACES OEM #

31-7536350
Heat Treated

Replacement parts produced by Kooima® Company to fit White™

SCTK110

\$6.50 per kit



- Stationary chopper knife
- To fit many popular machines
- Kit includes:
 - (1) tooth
 - (1) bolt
 - (1) lock washer
 - (1) hex nut
- .6 lbs./kit

7534020
Heat Treated

KOOIMA® REPLACEMENT PARTS TO FIT OLIVER®- WHITE™ CORN HEADS

Oliver® is a registered trademark of AGCO Corporation, which does not manufacture, distribute or endorse these parts.

KOOIMA #
KWH200

\$17.30 ea.



DESCRIPTION

- Snapping roll flute
- To fit all 700 series heads
- 3 required per roll
- 3 lbs.

REPLACES OEM #

31-1574370
Heat Treated

Replacement parts produced by Kooima® Company to fit Oliver®-White™



IMPORTANT TERMS AND CONDITIONS OF SALE

At Kooima[®] Company our goal is to manufacture quality replacement parts that meet your needs. For additional information or to place an order, telephone toll free 1-800-522-8874 or visit our website at www.kooima.com.

BUSINESS HOURS: 7:00 a.m. - 5:00 p.m. Monday through Friday (CST).

PRICES: All prices are in US Dollars. Prices are subject to change without notice. All shipments are billed at the prices in effect at the time of ordering. For the most current prices, go to www.kooima.com.

BILLING AND TERMS: Methods of payment include MasterCard[®], Visa[®], Discover[®], American Express[®] and John Deere[®] Financial, and Check by Phone. Personal checks (payable to: Kooima Company) are accepted with the understanding that the check must be received in our office before the merchandise can be shipped.



JOHN DEERE[®]
FINANCIAL

RETURN PROCEDURE: Return new or unused products to Kooima[®] Company within one year of delivery. Damaged or defective products must be returned within 30 days for a refund or exchange; please keep all packing materials for inspection. Before returning parts, you must contact our sales department to acquire a Return Goods Authorization (RGA) number and shipping instructions. The RGA Number must be clearly marked on the outside of the package, with a Kooima[®] packing list or invoice included. Return parts will be subject to a 10% restocking charge. Proper credit (for the cost of product only) will be issued to the original form of payment after the product has been received, or an exchange will be sent promptly if requested. Returns must be purchased from Kooima[®] and in marketable condition (excluding warranty returns). Unfortunately we cannot accept packages sent freight collect or COD.

Send returns prepaid to:

Kooima[®] Company
2638 310th Street
Rock Valley, IA 51247

FREIGHT POLICY: Kooima[®] Company will pay all shipping charges on offline retail orders totaling \$750.00 or more, including truck freight charges, in the continental United States. Free shipping on retail internet orders in the continental U.S. (continue reading for policy on silage covers). Freight policy for silage covers: Free shipping on Silage Covers if combined with \$750.00 in Kooima[®] parts on phone and internet orders. For orders going to Canada: Kooima[®] Company will pay shipping charges only, on orders totaling \$1,500.00 U.S. dollars or more (not including other fees, taxes, duties, etc.). Shipping to Canada: Duties, taxes, and broker fees apply (no COD). Express orders do not qualify for free shipping. Dealers and Distributors do not qualify for free freight.

BACK ORDERS: All orders will be shipped the same day as received when at all possible. Occasionally items may be temporarily back-ordered due to circumstances beyond our control. These items will be shipped as soon as available and priced according to prices in effect at the time of the original order.

WARRANTY: The products sold or supplied by Kooima[®] shall have the warranty (if any) of the manufacturer or other supplier to Kooima[®]. Kooima[®] Company disclaims all warranties either express or implied, including but not limited to implied warranties of MERCHANTABILITY and FITNESS FOR A PARTICULAR PURPOSE with respect to any merchandise purchased from Kooima[®], the Kooima[®] website or catalog. Kooima's[®] liability in connection with a customer's purchase is expressly limited to Kooima's[®] Return Procedure set forth above. Kooima[®] will not assume responsibility for shipping and handling costs, loss of crop or loss of time for any warranted products. Limited warranty on knives and shearbars that ingest stones, wood, steel etc.; all claims for consequential, incidental or special damages are hereby excluded. In no event shall Kooima's[®] liability under this warranty exceed the purchase price paid for the product.

Note: UPS does not deliver to PO Boxes. Please enter a street address for your delivery address.

ORDERING OPTIONS

Online

www.kooima.com



Call

1-800-522-8874

Fax

712-476-6283



Mail

2638 310th St.

P.O. Box 156

Rock Valley, IA 51247



SHIPPING TIME

Estimated UPS® delivery times from Rock Valley, IA for Continental U.S.

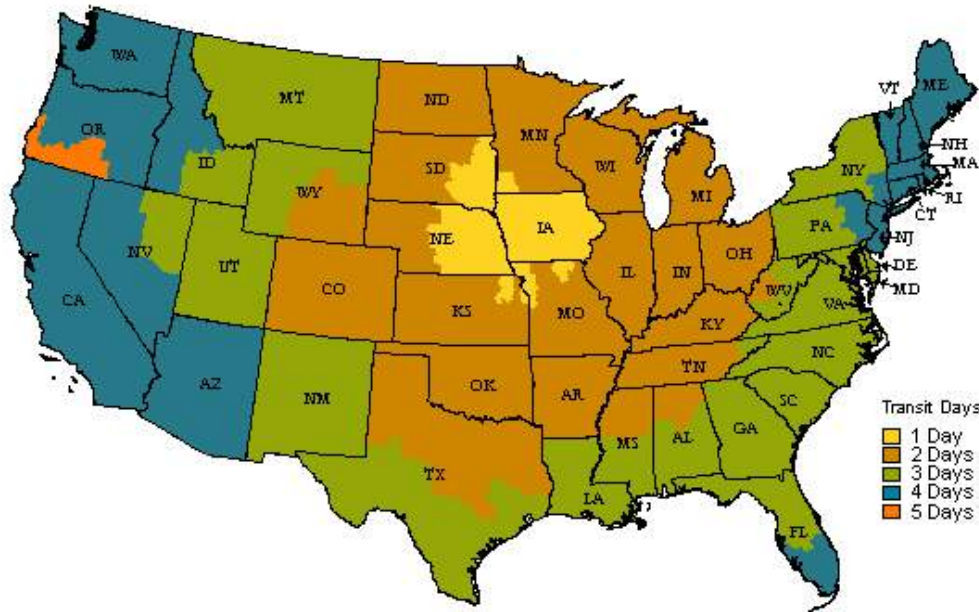

Estimated FedEx® truck freight delivery times from Rock Valley, IA for Continental U.S.

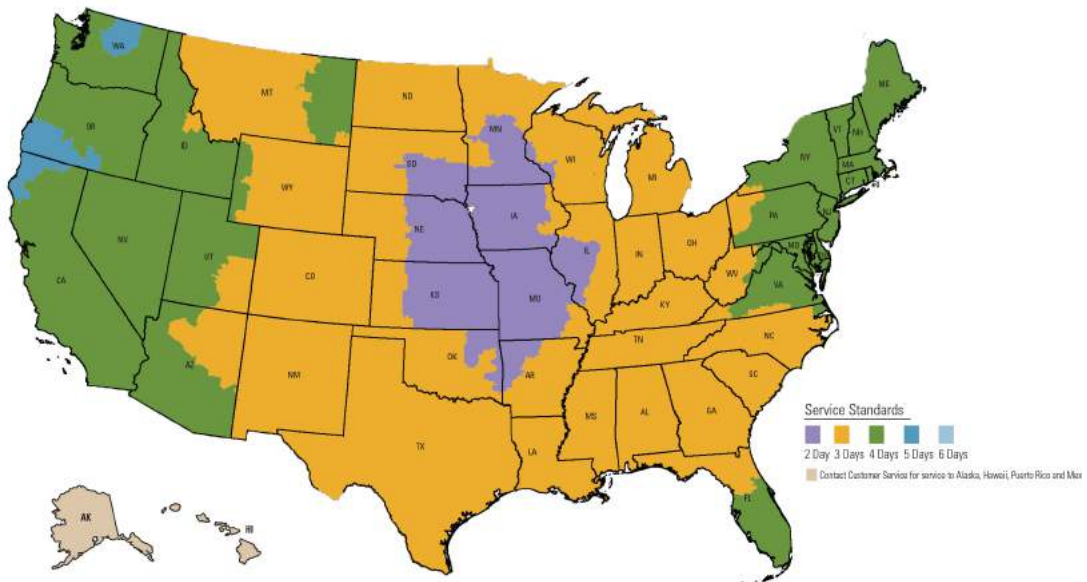

Spee-Dee™ Service Areas



Kooima® is conveniently located in the center of the United States to get your parts to you as rapidly as possible! In most instances there will be same day shipping on all in stock orders placed by 3:00 p.m. (CST).



TURNER[®] COMPOSTER

Tunnel Dimensions:

8 ft wide x 4 ft tall

Skid Loader Requirements:

Min. lift capacity 1600 lbs.

Working: Ø 24"

S
P
E
C
S

Patent Pending

Skid Trner[®]

Model # CT0800

\$10,700

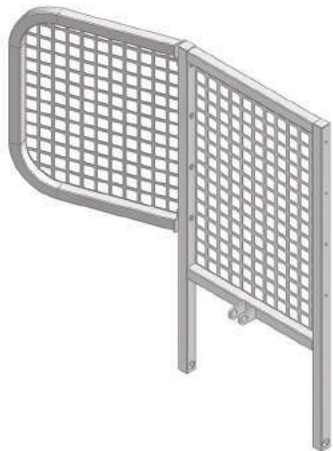

Protect yourself and your tractor with a Kooima Safety Screen. Available in easy to replace sections - Customize to fit your particular needs with full or partial coverage!

Safety Screen Kit

- Includes 1 C50024-01, 1 C50024-02 & hardware
- 245 lbs.

Order # C50024

\$1,100⁰⁰ ea.

Side Shield

- 89 lbs.
- Bolt kit: C50024BK \$6.00, one required per shield

Order # C50024-01

\$513³⁰ ea.



Center Shield

- 154 lbs.

Order # C50024-02

\$713³⁰ ea.



3 ft. Heavy Duty Compost Thermometer

Order # C00416

\$119⁷⁵ ea.



Check out our website to watch videos of our Turner[®] Composters in action!

TURNER[®] COMPOSTER

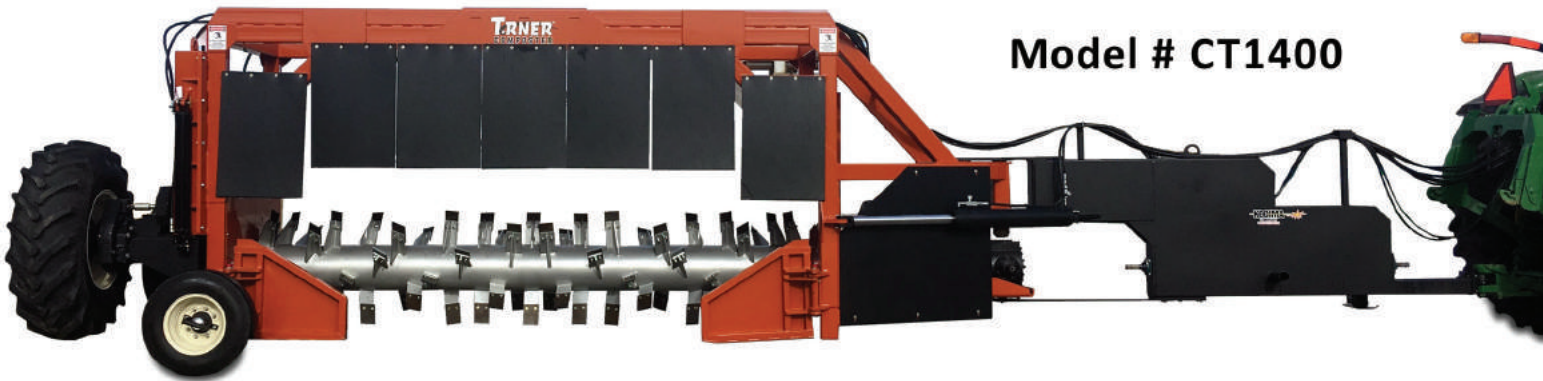

Model # CT1400



- High capacity compost turner
- Heavy duty design specifically for manure composting
- Designed for easy serviceability
- Proven in harsh conditions
- Faster ground speed - compare ours to any other
- 3" Diameter through shaft on the drum means more rigidity and higher throughput
- Box frame construction - Tough!
- High clearance to handle larger piles
- Drum designed to throw material back farther with less horsepower
- Hydraulically driven wheel - more speed and traction
- Road towable - tongue easily pivots for transport
- Patent pending paddle design - incorporates more oxygen into the pile

S
P
E
C
S

Tunnel Dimensions:

14 ft wide x 7 ft tall

Tractor Requirements:

130 HP min. 300 HP max.

Drum: Ø 14"

Working: Ø 36"



Check out our website to see the Trner[®] in action!

WE HAVE THE REPLACEMENT PARTS YOU **NEED!**

KOOIMA® TRNER® COMPOSTERS

Patents Pending - See the back inside page for more information!



Call

1.800.522.8874

Our knowledgeable sales staff is ready to serve you.



Online

www.kooima.com

Thousands of products available
24 hours a day, 7 days a week!



Mail

2638 310th St., P.O. Box 156
Rock Valley, IA 51247

Fax: 712.476.6283

E-mail: sales@kooima.com

KOOIMA® COMPANY



© 2019 Kooima® Company. Printed in the U.S.A.

All rights reserved. No part of this catalog may be reproduced or transmitted in any form, by any means, without the prior written permission from Kooima® Company.